

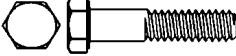

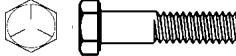

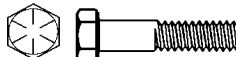

SECTION A

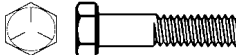

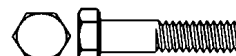
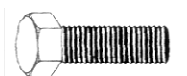



BOULONS / BOLTS

INFORMATION TECHNIQUE.....DÉBUT DE LA SECTION
 TECHNICAL INFORMATION.....BEGINNING OF THIS SECTION

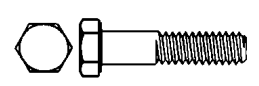
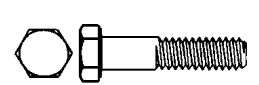
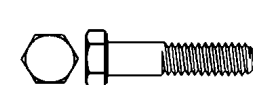
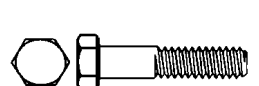
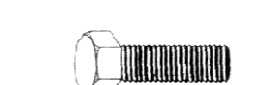
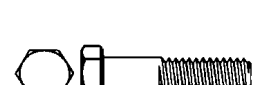
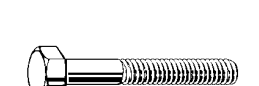
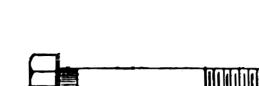
	DESCRIPTION	SECTION-PAGE
	BOULONS À TÊTE HEX, GRADE 2, <i>GROS FILETS</i> , NOIR & ZINC. HEX HEAD CAP SCREWS, GRADE 2, <i>NATIONAL COARSE</i> , BARE & PLATED.	A-1
	BOULONS À TÊTE HEX, GRADE 5, <i>GROS FILETS</i> , NOIR & ZINC. HEX HEAD CAP SCREWS, GRADE 5, <i>NATIONAL COARSE</i> , BARE & PLATED.	A-13
	BOULONS À TÊTE HEX, GRADE 8, <i>GROS FILETS</i> , NOIR & ZINC. HEX HEAD CAP SCREWS, GRADE 8, <i>NATIONAL COARSE</i> , BARE & PLATED.	A-25
	BOULONS À TÊTE HEX, GRADE 5, <i>FILETS FINS</i> , NOIR & ZINC. HEX HEAD CAP SCREWS, GRADE 5, <i>NATIONAL FINE</i> , BARE & PLATED.	A-37
	BOULONS À TÊTE HEX, GRADE 8, <i>FILETS FINS</i> , NOIR & ZINC. HEX HEAD CAP SCREWS, GRADE 8, <i>NATIONAL FINE</i> , BARE & PLATED.	A-49
	BOULONS À TÊTE HEX, L-9, <i>GROS FILETS</i> , ZINC. HEX HEAD CAP SCREWS, L-9, <i>NATIONAL COARSE</i> , PLATED.	A-59
	BOULONS À TÊTE HEX, L-9, <i>FILETS FINS</i> , ZINC. HEX HEAD CAP SCREWS, L-9, <i>NATIONAL FINE</i> , PLATED.	A-65
	BOULONS À TÊTE HEX FILETÉS COMPLETS, GRADE 2 & 5, ZINC. HEX TAP BOLTS THREADED TO THE HEAD, GRADE 2 & 5, PLATED.	A-72
	BOULONS DE CONSTRUCTION TÊTE HEX AVEC ÉCROUS ET RONDELLES STRUCTURAL BOLTS HEX HEAD COME WITH WASHERS & NUTS	A-73
	BOULONS À TÊTE HEX, <i>GROS FILETS</i> , SS-304 / 18-8. HEX HEAD CAP SCREWS, <i>NATIONAL COARSE</i> , SS-304 / 18-8.	A-77
	BOULONS À TÊTE HEX, <i>GROS FILETS</i> , SS-316. HEX HEAD CAP SCREWS, <i>NATIONAL COARSE</i> , SS-316.	A-83
	BOULONS À TÊTE HEX, <i>FILETS FINS</i> , SS 304 & SS-316. HEX HEAD CAP SCREWS, <i>NATIONAL FINE</i> , SS 304 & SS-316.	SUR DEMANDE ON REQUEST







SECTION A

BOULONS / BOLTS

	DESCRIPTION	SECTION-PAGE
	BOULONS À TÊTE HEX, <i>GROS FILETS</i> , H.D.G. HEX HEAD CAP SCREWS, <i>NATIONAL COARSE</i> , H.D.G.	A-87
	BOULONS À TÊTE HEX, LAITON. HEX HEAD CAP SCREWS, BRASS.	A-86
	BOULONS À TÊTE HEX, ALUMINIUM. HEX HEAD CAP SCREWS, ALUMINUM.	SUR DEMANDE ON REQUEST
	BOULONS À TÊTE HEX, CLASSE 8.8, <i>DIN 931</i> , NOIR & ZINC. HEX HEAD CAP SCREWS, CLASS 8.8, <i>DIN 931</i> , BARE & PLATED	A-88
	BOULONS À TÊTE HEX, CLASSE 8.8, <i>DIN 933</i> , NOIR & ZINC. HEX HEAD CAP SCREWS, CLASS 8.8, <i>DIN 933</i> , BARE & PLATED.	SUR DEMANDE ON REQUEST
	BOULONS À TÊTE HEX, CLASSE 10.9, <i>DIN 931</i> , NOIR & ZINC. HEX HEAD CAP SCREWS, CLASS 10.9, <i>DIN 931</i> , BARE & PLATED.	SUR DEMANDE ON REQUEST
	BOULONS À TÊTE HEX, <i>MÉTRIQUE</i> , ACIER INOX. HEX HEAD CAP SCREWS, <i>METRIC</i> , STAINLESS STEEL.	A-96
	BOULONS À MOLETTE TÊTE HEXAGONALE SHACKLE BOLTS	SUR DEMANDE ON REQUEST
	BOULONS À TÊTE CARRÉE, GRADE 2 & 5, NOIR. SQUARE HEAD BOLTS, GRADE 2 & 5, BARE.	SUR DEMANDE ON REQUEST
	BOULONS À COLLERETTE, GRADE 5, ZINC. FLANGE BOLTS, GRADE 5, PLATED.	A-97
	BOULONS DE CAROSSERIE, GRADE 2, ZINC. CARRIAGE BOLTS, GRADE 2, PLATED.	A-98
	BOULONS DE CAROSSERIE, GRADE 2, NOIR. CARRIAGE BOLTS, GRADE 2, BARE .	SUR DEMANDE ON REQUEST
	BOULONS DE CAROSSERIE, GRADE 5, NOIR & ZINC. CARRIAGE BOLTS, GRADE 5, BARE & PLATED .	SUR DEMANDE ON REQUEST



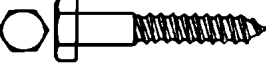
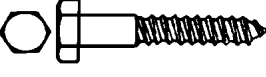

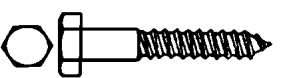
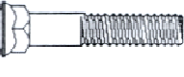
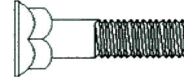
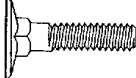
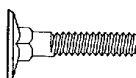
SECTION A

BOULONS / BOLTS

DESCRIPTION	SECTION-PAGE	
	BOULONS DE CARROSSERIE, GRADE 8, NOIR & ZINC. CARRIAGE BOLTS, GRADE 8, BARE & PLATED .	SUR DEMANDE ON REQUEST
	BOULONS DE CARROSSERIE, ACIER INOXYDABLE CARRIAGE BOLTS, STAINLESS STEEL	SUR DEMANDE ON REQUEST
	BOULONS DE CARROSSERIE, MÉTRIQUE , ZINC. CARRIAGE BOLTS METRIC , PLATED.	SUR DEMANDE ON REQUEST
	BOULONS DE CARROSSERIE, H.D.G. CARRIAGE BOLTS, H.D.G.	SUR DEMANDE ON REQUEST
	BOULONS DE CARROSSERIE À TÊTE PLATE, ZINC. FLAT CARRIAGE BOLTS, PLATED.	SUR DEMANDE ON REQUEST
	TIRE-FOND, PLATED. LAG SCREWS, ZINC.	A-102
	TIRE-FOND, NOIR. LAG SCREWS, BARE.	SUR DEMANDE ON REQUEST
	TIRE-FOND, ACIER INOXYDABLE. LAG SCREWS, STAINLESS STEEL.	SUR DEMANDE ON REQUEST
	TIRE-FOND, H.D.G. LAG SCREWS, H.D.G.	SUR DEMANDE ON REQUEST
	BOULONS DE LAME À CALOTTE À TÊTE #3 , GRADE 8, NOIR. SCRAPER BOLTS #3 DOME HEAD ,GRADE 8,BARE.	A-105
	BOULONS DE CHARRUE , À TÊTE #3 , GRADE 5, NOIR. PLOW BOLTS , #3 FLAT HEAD ,GRADE 5, BARE.	A-106
	BOULONS D'ÉLÉVATEUR, NOIR. ELEVATOR BOLTS, BARE.	A-108
	BOULONS D'ÉLÉVATEUR, ZINC. ELEVATOR BOLTS, PLATED	SUR DEMANDE ON REQUEST

SECTION A

BOULONS / BOLTS

	DESCRIPTION	SECTION-PAGE
	BOULONS À ŒIL , <i>AVEC ÉPAULEMENT</i> , ACIER FORGÉ AU CARBONE. EYE BOLTS, <i>SHOULDER PATTERN</i> , FORGED CARBON STEEL.	A-109
	BOULONS À ŒIL, <i>SANS ÉPAULEMENT</i> , ACIER FORGÉ AU CARBONE . EYE BOLTS, <i>PLAIN PATTERN</i> , FORGED CARBON STEEL.	SUR DEMANDE ON REQUEST
	BOULONS À ŒIL AVEC ÉCROUS EYE BOLTS AND NUTS	A-110
	BOULONS EN "U" "U" BOLT	A-111

**TABLE DES FILETS
THREADS TABLE**

IMPÉRIAL			BRITISH			MÉTRIQUE		
COARSE		FINE	COARSE		FINE	COARSE		FINE
	0000	160	B.S.W		B.S.F	0,25	1	0,2
	000-	120	60	1/16-		0,25	1,1	
	00	96	48	3/32-		0,25	1,2	0,2
	00	90	40	1/8-		0,3	1,4	
	0	80	32	5/32-		0,3	1,5	0,2
64	1-	72	24	3/16-	32	0,35	1,6	
56	2-	64	24	7/32-	28	0,35	1,7	0,2
48	3-	56	20	1/4-	26	0,35	1,8	
40	4-	48	„	9/32-	26	0,4	2	0,25
40	5-	44	18	5/16-	22	0,45	2,2	
32	6-	40	16	3/8-	20	0,4	2,3	
32	8-	36	14	7/16-	18	0,45	2,5	
24	10-	32	12	1/2-	16	0,45	2,6	0,35
24	12-	28	12	9/16-	16	0,5	3	0,35
20	1/4-	28	11	5/8-	14	0,6	3,5	0,35
18	5/16-	24	11	11/16-	14	0,7	4	0,5
16	3/8-	24	10	3/4-	12	0,75	4,5	0,5
14	7/16-	20	9	7/8-	11	0,8	5	0,5
13	1/2-	20	8	1-	10	1	6	0,75
12	9/16-	18	7	1-1/8-	9	1	6,3	
11	5/8-	18	7	1-1/4-	9	1	7	0,75
10	3/4-	16	6	1-3/8-	8	1,25	8	1
9	7/8-	14	6	1-1/2-	8	1,25	9	1
8	1-	12-14*	5	1-5/8-	8	1,5	10	1,25/1,00
7	1-1/8	12	5	1-3/4-	7	1,5	11	1
7	1-1/4	12	4,5	1-7/8-	7	1,75	12	1,50/1,25
6	1-3/8	12	4,5	2-	7	2	14	1,5
6	1-1/2	12	4	2-1/4-	6	2	16	1,5
5	1-3/4	12	4	2-1/2-	6	2,5	18	1,5
4-1/2-	2-	12	3,5	2-3/4-	6	2,5	20	1,5
			3,5	3-	5	2,5	22	1,5
			3,25	3-1/4-	5	3	24	2
			3,25	3-1/2-	4,5	3	27	2
			3	3-3/4-	4,5	3,5	30	2
			3	4-	4,5	3,5	33	2
						4	36	3
						4	39	3
						4,5	42	3

* NOTE : 12 = SPECIAL
14 = ORD



Tel.: (819) 346-2903 / (888) 345-2903 Fax.: (819) 346-3389
Email: distributeur@boulonstrie.com

INFO TECHNIQUE A (T-1)

TABLE DES FILETS SPÉCIAUX SPECIAL THREADS

FILETAGE SPÉCIAL B-7 SPECIAL THREAD B-7	FILETAGE RÉGULIER ACME STANDARD ACME THREAD	
1/4"-20 5/16"-18 3/8"-16 7/16"-14 1/2"-13 5/8"-11 3/4"-10 7/8"-9 1"-8 1-1/8"-8 1-1/4"-8 1-3/8"-8 1-1/2"-8 1-5/8"-8 1-3/4"-8 2"-8	1/4"-16 5/16"-14 3/8"-10 spécial 3/8"-12 7/16"-10 spécial 7/16"-12 1/2"-10 5/8"-8 3/4"-6 7/8"-6 1"-4 spécial 1"-5 1-1/8"-5 1-1/4"-5	1-3/8"-4 1-1/2"-4 1-3/4"-4 2"-4 2-1/4"-3 2-1/2"-3 2-3/4"-3 3"-2 4"-2 4-1/2"-2 5"-2
Filetage National à Tuyaux N.P.T. National pipe thread	Diamètre nominal du filetage des vis Screw thread nominal diameter	
1/16"-27 M-8 X 1 1/8"-27 M-10 X 1 1/4"-18 M-12 X 1,5 3/8"-18 M-14 X 1,5 1/2"-14 M-16 X 1,5 3/4"-14 M-18 X 1,5 1"-11 1/2 M-20 X 1,5 1-1/4"-11 1/2 M-22 X 1,5 2"-11 1/2 M-24 X 1,5 2-1/2"-8 M-26 X 1,5 3"-8 M-30 X 1,5 3-1/2"-8 M-36 X 1,5 4"-8 5"-8 6"-8	Grandeur / Size = Diamètre / Major Diam. 0 = 0,0600" 1 = 0,0730" 2 = 0,0860" 3 = 0,0990" 4 = 0,1120" 5 = 0,1250" 6 = 0,1380" 7 = 0,1510" 8 = 0,1640" 9 = 0,1770" 10 = 0,1900" 12 = 0,2160" 14 = 0,2420" 16 = 0,2680" 18 = 0,2940" 20 = 0,3200" 24 = 0,3720"	



Tel.: (819) 346-2903 / (888) 345-2903 Fax.: (819) 346-3389
 Email: distributeur@boulonsestrie.com

LONGUEURS DE FILETAGES STANDARD STANDARD THREAD LENGTH

BOULONS STANDARD

DIAMÈTRE DU BOULON	LONGUEUR DU FILETAGE / THREAD LENGHT	
BOLT DIAMETER	6" ET MOINS	PLUS QUE 6"
	6" AND SHORTER	LONGER THAN 6"
1/4	3/4	1
5/16	7/8	1 1/8
3/8	1	1-1/4
7/16	1-1/8	1-3/8
1/2	1-1/4	1-1/2
5/8	1-1/2	1-3/4
3/4	1-3/4	2
7/8	2	2-1/4
1	2-1/4	2-1/2
1-1/8	2-1/2	2-3/4
1-1/4	2-3/4	3
1-3/8	3	3-1/4
1-1/2	3-1/4	3-1/2
1-5/8	3-1/2	3-3/4
1-3/4	3-3/4	4
2	4	4-1/4
2 1/4		
2 1/2		
2 3/4		
3		
3 1/4		
3 1/2		
3 3/4		
3 1/2		
3 3/4		
4		



Tel.: (819) 346-2903 / (888) 345-2903 Fax.: (819) 346-3389
Email: distributeur@boulonsestrie.com

DIMENSIONS DES TÊTES DE BOULONS BOLT HEAD DIMENSIONS

DIMENSION	BOULON HEX RÉGULIER		BOULON HEX ROBUSTE		TÊTE CARRÉE	
SIZE	REGULAR HEX HEAD		HEAVY HEX HEAD		SQUARE HEAD	
DIAMÈTRE BOULON	PLAT À PLAT	HAUTEUR TÊTE	PLAT À PLAT	HAUTEUR TÊTE	PLAT À PLAT	HAUTEUR TÊTE
BOLT DIAMETER	ACROSS FLAT	HEAD HEIGHT	ACROSS FLAT	HEAD HEIGHT	ACROSS FLAT	HEAD HEIGHT
1/2	3/4	11/32	7/8	11/32	3/4	21/64
5/8	15/16	27/64	1 1/16	27/64	15/16	27/64
3/4	1 1/8	1/2	1 1/4	1/2	1 1/8	1/2
7/8	1 5/16	37/64	1 7/16	37/64	1 5/16	19/32
1	1 1/2	43/64	1 5/8	43/64	1 1/2	21/32
1 1/8	1 11/16	3/4	1 13/16	3/4	1 11/16	3/4
1 1/4	1 7/8	27/32	2	27/32	1 7/8	1 5/32
1 3/8	2 1/16	29/32	2 3/16	29/32	2 1/16	29/32
1 1/2	2 1/4	1	2 3/8	1	2 1/4	1
1 5/8	2 7/16	1 5/64	2 9/16	1 5/64	2 9/16	1 5/64
1 3/4	2 5/8	1 3/32	2 3/4	1 3/32	2 3/4	1 3/32
1 7/8	2 13/16	1 15/64	2 15/16	1 15/64	2 15/16	1 15/64
2	3	1 11/32	3 1/8	1 11/32	3 1/8	1 11/32
2 1/4	3 3/8	1 1/2	3 1/2	1 1/2	3 1/2	1 1/2
2 1/2	3 3/4	1 21/32	3 7/8	1 21/32	3 7/8	1 21/32
2 3/4	4 1/8	1 13/16	4 1/4	1 13/16	4 1/4	1 13/16
3	4 1/5	2	4 5/8	2	4 5/8	2







Tel.: (819) 346-2903 / (888) 345-2903 Fax.: (819) 346-3389

Email: distributeur@boulonstrie.com

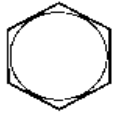
INFO TECHNIQUE A (T-4)

CHARTE DE SPÉCIFICATION BOUL SELECTING FASTENER MATERIAL

	SPECIFICATION	MATERIAL	MINIMUM TENSILE
	ASTM A307 SAE J-429 GRADE 2	C1020 LOW CARBON STEEL	60 000 PSI FROM 1/4" TO 3/4" FROM 7/8" TO 1-1/2"
	ASTM A449 SAE J-429 GRADE 5	C1035-1041 MEDIUM CARBON STEEL	UP TO 1" DIA. INC OVER 1" TO 1 1/2"
	ASTM A354 SAE J-429 GRADE 8	ALLOY STEEL	FROM 1/4" TO 1 1/2"
	GRADE 12 / L-9	ALLOY STEEL HEAT TREATED	Minimum Tensile St
8,8 	METRIC CLASS 8.8 = GRADE 5	MEDIUM CARBON STEEL, QUENCHED & TEMPERED	DIA. M3 TO M16 : 800 ABOVE M16 : 830 N
10,9 	METRIC CLASS 10.9 = GRADE 8	MEDIUM CARBON STEEL, QUENCHED & TEMPERED	Tensile Strength 1040 N Rockwell Hardness -

IONS AL

LE (PSI)
1": 74 000 PSI 2": 60 000 PSI
EXCLUDED: 120 000 PSI INCLUDED: 105 000 PSI
2" : 150 000 PSI
length: 180 000 PSI
PSI = Ref. Only N/mm ² (App.116 000 PSI) l/mm ² (App.120 000 PSI)
PSI = Ref. Only N/mm ² (App. 150 000 PSI)
Min C32 Max C39

INFO TECHNIQUE A (T-5)

BOLT CLAMP LOADS - SUGGESTED ASSEMBLY TORQUE VALUES

DIA.& THDS. PER IN.	SAE GRADE 2 THRU 6" LONG						SAE GRADE 5					SAE GRADE 8					L9 FASTENING SYSTEM			TORQUE BY HEAD FT.LB.
	STRESS AREA SQ. IN.	TENSILE Strenght MIN. KSI	PROOF LOAD LBS.	CLAMP LOAD LBS.	TORQUE		TENSILE Strenght MIN. KSI	PROOF LOAD LBS.	CLAMP LOAD LBS.	TORQUE		TENSILE Strenght MIN. KSI	PROOF LOAD LBS.	CLAMP LOAD LBS.	TORQUE		TENSILE Strenght MIN. KSI	PROOF LOAD LBS.	CLAMP LOAD LBS.	
					DRY FT.LB.	LUB. FT.LB.				DRY FT.LB.	LUB. FT.LB.				DRY FT.LB.	LUB. FT.LB.				
1/4-20 28	.0318 .0364	74 74	1750 2000	1310 1500	5.5 6.3	4.2 4.7	120 120	2700 3100	2020 2320	8 10	6.3 7.2	150 150	3800 4350	2850 3250	12 14	9 10	180 180	4610 5270	3450 3950	10 12
5/16-18 24	.0524 .0580	74 74	2900 3200	2160 2400	11 12	8 9	120 120	4450 4900	3340 3700	17 19	13 14	150 150	6300 6950	4700 5200	24 27	18 20	180 180	7590 8410	5700 6300	19 20
3/8-16 24	.0775 .0878	74 74	4250 4800	3200 3620	20 23	15 17	120 120	6600 7450	4950 5600	30 35	23 25	150 150	9300 10500	6980 7900	45 50	35 35	180 180	11230 12730	8450 9550	30 35
7/16-14 20	.1063 .1187	74 74	5850 6550	4380 4900	32 36	24 27	120 120	9050 10100	6780 7570	50 55	35 40	150 150	12800 14200	9550 10650	70 80	50 60	180 180	15410 17210	11550 12900	55 60
1/2-13 20	.1419 .1599	74 74	7800 8800	5850 6600	50 55	35 40	120 120	12100 13600	9050 10200	75 85	55 65	150 150	17000 19200	12750 14400	110 120	80 90	180 180	20570 23180	15450 17400	85 95
9/16-12 18	.1820 .2030	74 74	10000 11200	7500 8400	70 80	55 60	120 120	15500 17300	11600 12950	110 120	80 90	150 150	21800 24400	16350 18250	150 170	110 130	180 180	26390 29430	19800 22100	120 135
5/8-11 18	.226 .256	74 74	12400 14100	9320 10560	100 110	75 85	120 120	19200 21800	14400 16350	150 170	110 130	150 150	27100 30700	20350 23000	210 240	160 180	180 180	32770 37120	24550 27800	170 190
3/4-10 16	.334 .373	74 74	18400 20500	13800 15390	175 200	130 140	120 120	28400 31700	21300 23780	260 300	200 220	150 150	40100 44800	30100 33500	380 420	280 310	180 180	48430 54080	36350 40600	265 330
7/8-9 14	.462 .509	60 60	15200 16800	11430 12600	170 180	125 140	120 120	39300 43300	29450 32450	430 470	320 350	150 150	55400 61100	41600 45800	600 670	450 500	180 180	66990 73800	50300 55400	475 520
1-8 14	.606 .679	60 60	20000 22400	15000 16800	250 280	190 210	120 120	51500 57700	38600 43300	640 720	480 540	150 150	72700 81500	54500 61100	910 1020	680 760	180 180	87870 98450	65900 73800	550 700
1-1/8-7 12	.763 .856	60 60	25200 28200	18900 21200	350 400	270 300	105 105	56500 63300	42300 47500	790 890	590 670	150 150	91600 102700	68700 77000	1290 1440	970 1080	180 180	110630 124120	83000 93100	1025 1150
1-1/4-7 12	.969 1.073	60 60	32000 35400	24000 26550	500 550	380 420	105 105	71700 79400	53800 59600	1120 1240	840 930	150 150	116300 128800	87200 96600	1820 2010	1360 1510	180 180	140500 155580	105400 116700	1400 1600
1-1/2-6 12	1.405 1.581	60 60	46400 52200	34800 39150	870 980	650 730	105 105	104000 117000	78000 87700	1950 2200	1460 1640	150 150	168600 189700	126500 142200	3160 3560	2370 2670	180 180	203720 229240	152800 171900	2900 3300



Tel.: (819) 346-2903 / (888) 345-2903 Fax.: (819) 346-3389

Email: distributeur@boulonstrie.com

DIMENSIONS DES BOULONS DE CONSTRUCTION DIMENSIONS OF STRUCTURAL BOLTS

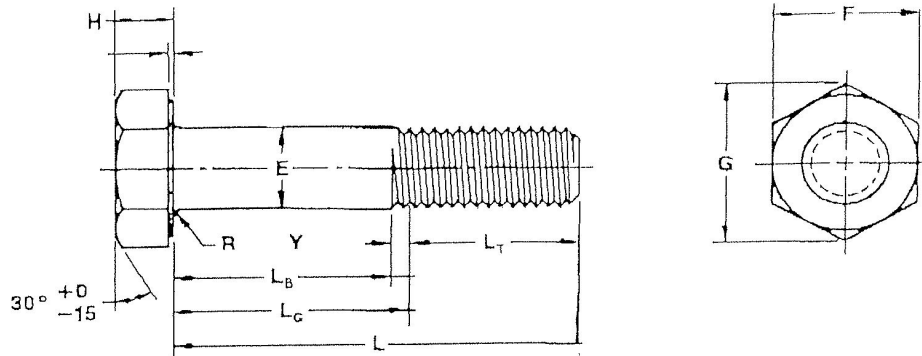

Nominal Size or Basic Product Dia.	E		F			G		H			R		Lt	Y	Runout of Bearing Surface FIM
	Body Dia.		Width Across Flats			Width Across Corners		Height			Radius of Fillet		Thread Length	Transition Thread Lg	
	Max	Min	Basic	Max	Min	Max	Min	Basic	Max	Min	Max	Min	Basic	Max	Max
1/2 0.5000	0.515	0.482	7/8.	0.875	0.850	1.010	0.969	5/16.	0.323	0.302	0.031	0.009	1.00	0.19	0.016
5/8 0.6250	0.642	0.605	1-1/16.	1.062	1.031	1.227	1.175	25/64	0.403	0.378	0.062	0.021	1.25	0.22	0.019
3/4 0.7500	0.768	0.729	1-1/4.	1.250	1.250	1.443	1.383	15/32	0.483	0.455	0.062	0.021	1.38	0.25	0.022
7/8 0.8750	0.895	0.852	1-7/16.	1.438	1.438	1.660	1.589	35/64	0.563	0.531	0.062	0.031	1.50	0.28	0.025
1 1.0000	1.022	0.976	1-5/8.	1.625	1.575	1.876	1.796	39/64	0.827	0.591	0.093	0.062	1.75	0.31	0.028
1-1/8 1.1250	1.149	1.098	1-13/16.	1.812	1.756	2.093	2.002	11/16.	0.718	0.658	0.093	0.062	2.00	0.34	0.032
1-1/4 1.2500	1.277	1.223	2	2.000	1.938	2.309	2.209	25/32	0.813	0.749	0.093	0.062	2.00	0.38	0.035
1-3/8 1.3750	1.404	1.345	2-3/16.	2.188	2.119	2.526	2.416	27/32	0.878	0.810	0.093	0.062	2.25	0.44	0.038
1-1/2 1.5000	1.531	1.470	2-3/8.	2.375	2.300	2.742	2.622	15/16	0.974	0.902	0.093	0.062	2.25	0.44	0.041



Tel.: (819) 346-2903 / (888) 345-2903 Fax.: (819) 346-3389

Email: distributeur@boulonstrie.com

BOULONS DE CONTRUCTION / STRUCTURAL BOLTS

IDENTIFICATION BOULON / ÉCROU / RONDELLE PROPRIÉTÉ MÉCANIQUE

Diamètre & Filet	A325 Bolts		A490 Bolts		A325 Nuts	A194 Grade 2H Nuts
	Proof 1 Load Lb	Tensile 2 Strenght Min Lb	Proof 1 Load Lb	Tensile 2 Strenght Min Lb	Proof 1 Load Lb	Proof 3 Load Lb
½-13 UNC	12,050	17,050	17,050	21,300	20,450	24,850
5/8-11 UNC	19,200	27,100	27,100	33,900	32,550	39,550
¾-10 UNC	28,400	40,100	40,100	50,100	48,100	58,450
7/8-9 UNC	39,250	55,450	55,450	69,300	66,550	80,850
1-8 UNC	51,500	72,700	72,200	90,900	87,250	160,000
1 1/8 – 7 UNC	56,450	88,100	91,550	114,450	109,900	133,500
1 1/8 – 8 UNC	58,450	82,950	94,800	118,500	113,800	138,200
1 1/4 – 7 UNC	71,700	101,700	116,300	143,350	139,500	169,600
1 1/4-8 UNC	74,800	105,000	120,000	150,000	144,000	175,000
1 3/8-6 UNC	85,450	131,300	138,600	173,250	156,300	202,100
1 3/8-8 UNC	91,250	129,500	148,000	185,000	177,600	215,800
1 1/2-6 UNC	104,000	147,500	168,000	210,750	202,300	245,900
1 1/2-8 UNC	110,400	156,700	175,050	223,800	214,800	261,100

- NOTES :**
1. Proof load of bolts is the load the bolt must support in axial tension Without permanent deformation.
 2. Tensile strenght of bolt is the minimum load the bolt must support in Axial tension without failure of the bolt.
 3. Proof load of nuts is the load the nut must support axially without Evidence of thread stripping or rupture.

TORQUE

Bolt Size Inches / Pouces	Job Inspection Torque Fool - Pounds	
	A325 Bolts	A490 Bolts
½	105	130
5/8	210	260
¾	370	460
7/8	595	750
1	890	1120
1-1/2	1100	1575
1-1/4	1550	2230
1-3/8	2040	2910
1-1/2	2700	3880

INFO TECHNIQUE A (T-8)

**PROPRIÉTÉS PHYSIQUES ET CHIMIQUES
DE L'ACIER INOXYDABLE
CHEMICAL AND PHYSICAL PROPERTIES
OF STAINLESS STEEL**

TYPE :

304	CARBONE / CARBON (max.)	0.08
	MAGNÉSIUM / MANGANESE (max.)	2.00
	SILICONE / SILICON (max.)	1.00
	CHROME / CHROMIUM	18.00/20.00
	NICKEL / NICKEL	8.00/12.00
316	CARBONE / CARBON (max)	0.10
	MAGNÉSIUM / MANGANESE (max)	2.00
	SILICONE / SILICON (max)	1.00
	CHROME / CHROMIUM	16.00/18.00
	NICKEL / NICKEL	10.00/14.00
	MOLYBDEUM	2.00/3.00

Rendement et durabilité augmentent de façon marquée durant le procédé de fabrication à froid de l'acier inoxydable. Les données et chiffres ci-dessous sont approximatifs et sont en fait plus élevés que ce qui est démontré.

Tensile, yield and hardness increase sharply during cold-formed manufacturing of stainless.

Figures below are approximate and are often much higher than shown.

Tension / Tensile - 100 000 – 125 000 psi

Rendement / Yield - 55 000 – 75 000 psi

Durabilité / Hardness - 100 Rockwell B

Imperméabilité magnétique / Magnetic permeability – 2.0 max.

SI LE PRODUIT EST FABRIQUÉ D'ACIER INOXYDABLE, IL EST NORMALEMENT DU TYPE A OU DU TYPE B ET NON DU TYPE AB.

STAINLESS SHEET METAL SCREWS ARE NORMALLY TYPE A OR TYPE B, NOT TYPE AB

INFO TECHNIQUE A (T-9)

BOULONS À TÊTE
 HEXAGONALE
 GRADE 2
 GROS FILETS

NOIR / BARE
 ZINC / PLATED

HEX HEAD
 CAP SCREWS
 GRADE 2
 NATIONAL COARSE

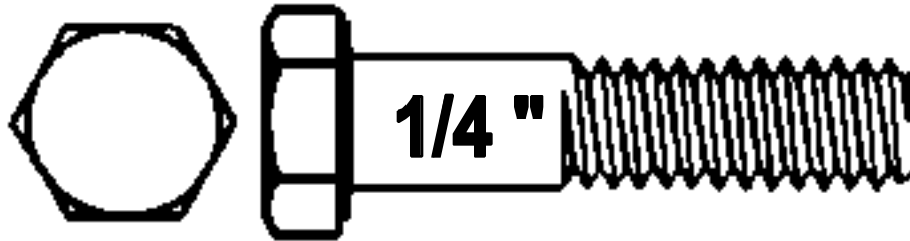

NOTRE CODE NOIR	NOTRE CODE ZINC	DESCRIPTION	QTÉ/BOITE	QTÉ/VRAC
OUR CODE BARE	OUR CODE PLATED	DESCRIPTION	QTY/BOX	QTY/BULK
BC125005	BC425005	1/4-20 X 1/2	100	3300
BC125006	BC425006	1/4-20 X 5/8	100	3000
BC125007	BC425007	1/4-20 X 3/4	100	2700
BC125008	BC425008	1/4-20 X 7/8	100	2500
BC125010	BC425010	1/4-20 X 1	100	2200
BC125012	BC425012	1/4-20 X 1 1/4	100	1900
BC125015	BC425015	1/4-20 X 1 1/2	100	1600
BC125017	BC425017	1/4-20 X 1 3/4	100	1400
BC125020	BC425020	1/4-20 X 2	100	1200
BC125022	BC425022	1/4-20 X 2 1/4	100	1000
BC125025	BC425025	1/4-20 X 2 1/2	100	900
BC125027	*****	1/4-20 X 2 3/4	100	750
BC125030	BC425030	1/4-20 X 3	100	750
BC125032	BC425032	1/4-20 X 3 1/4	100	600
BC125035	BC425035	1/4-20 X 3 1/2	100	550
BC125037	*****	1/4-20 X 3 3/4	100	500
BC125040	BC425040	1/4-20 X 4	100	450
BC125045	BC425045	1/4-20 X 4 1/2	100	450
BC125050	BC425050	1/4-20 X 5	100	400
BC125055	BC425055	1/4-20 X 5 1/2	100	400
BC125060	BC425060	1/4-20 X 6	100	350
BC125065	*****	1/4-20 X 6 1/2	100	350
BC125070	BC425070	1/4-20 X 7	100	300

AUTRES DIMENSIONS DISPONIBLES/OTHER DIMENSIONS ARE AVAILABLE



Tel.: (819) 346-2903 / (888) 345-2903 Fax.: (819) 346-3389

Email: distributeur@boulonsestrie.com

BOULONS À TÊTE
HEXAGONALE
GRADE 2
GROS FILETS

NOIR / BARE
ZINC / PLATED

HEX HEAD
CAP SCREWS
GRADE 2
NATIONAL COARSE

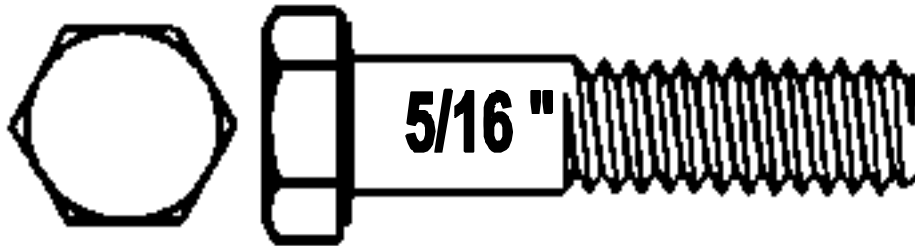

NOTRE CODE NOIR	NOTRE CODE ZINC	DESCRIPTION	QTÉ/BOITE	QTÉ/VRAC
OUR CODE BARE	OUR CODE PLATED	DESCRIPTION	QTY/BOX	QTY/BULK
BC131005	BC431005	5/16-18 X 1/2	100	1950
BC131006	BC431006	5/16-18 X 5/8	100	1800
BC131007	BC431007	5/16-18 X 3/4	100	1650
BC131008	BC431008	5/16-18 X 7/8	100	1500
BC131010	BC431010	5/16-18 X 1	100	1400
BC131012	BC431012	5/16-18 X 1 1/4	100	1100
BC131015	BC431015	5/16-18 X 1 1/2	100	1000
BC131017	BC431017	5/16-18 X 1 3/4	100	850
BC131020	BC431020	5/16-18 X 2	100	800
BC131022	BC431022	5/16-18 X 2 1/4	100	700
BC131025	BC431025	5/16-18 X 2 1/2	100	600
BC131027	BC431027	5/16-18 X 2 3/4	100	550
BC131030	BC431030	5/16-18 X 3	100	500
BC131032	BC431032	5/16-18 X 3 1/4	100	450
BC131035	BC431035	5/16-18 X 3 1/2	100	450
BC131040	BC431040	5/16-18 X 4	100	400
BC131045	BC431045	5/16-18 X 4 1/2	100	300
BC131050	BC431050	5/16-18 X 5	100	250
BC131055	BC431055	5/16-18 X 5 1/2	100	250
BC131060	BC431060	5/16-18 X 6	100	250

AUTRES DIMENSIONS DISPONIBLES/OTHER DIMENSIONS ARE AVAILABLE



Tel.: (819) 346-2903 / (888) 345-2903 Fax.: (819) 346-3389

Email: distributeur@boulonsestrie.com

BOULONS À TÊTE
 HEXAGONALE
 GRADE 2
 GROS FILETS

NOIR / BARE
 ZINC / PLATED

HEX HEAD
 CAP SCREWS
 GRADE 2
 NATIONAL COARSE

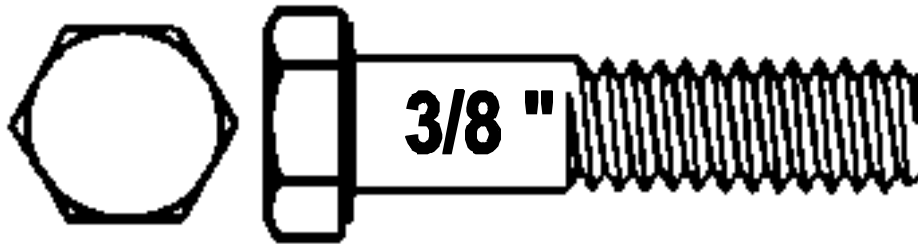

NOTRE CODE NOIR	NOTRE CODE ZINC	DESCRIPTION	QTÉ/BOITE	QTÉ/VRAC
OUR CODE BARE	OUR CODE PLATED	DESCRIPTION	QTY/BOX	QTY/BULK
BC137005	BC437005	3/8-16 X 1/2	100	1300
BC137006	BC437006	3/8-16 X 5/8	100	1200
BC137007	BC437007	3/8-16 X 3/4	100	1100
BC137008	BC437008	3/8-16 X 7/8	100	1000
BC137010	BC437010	3/8-16 X 1	100	900
BC137012	BC437012	3/8-16 X 1 1/4	100	800
BC137015	BC437015	3/8-16 X 1 1/2	100	675
BC137017	BC437017	3/8-16 X 1 3/4	100	600
BC137020	BC437020	3/8-16 X 2	100	550
BC137022	BC437022	3/8-16 X 2 1/4	100	450
BC137025	BC437025	3/8-16 X 2 1/2	100	400
BC137027	BC437027	3/8-16 X 2 3/4	100	400
BC137030	BC437030	3/8-16 X 3	100	325
BC137032	BC437032	3/8-16 X 3 1/4	100	325
BC137035	BC437035	3/8-16 X 3 1/2	100	300
BC137040	BC437040	3/8-16 X 4	100	250
BC137045	BC437045	3/8-16 X 4 1/2	100	225
BC137050	BC437050	3/8-16 X 5	100	225
BC137055	BC437055	3/8-16 X 5 1/2	100	175
BC137060	BC437060	3/8-16 X 6	100	175
BC137065	BC437065	3/8-16 X 6 1/2	100	175
BC137070	BC437070	3/8-16 X 7	100	150
BC137075	*****	3/8-16 X 7 1/2	50	150
BC137080	BC437080	3/8-16 X 8	50	150
BC137085	BC437085	3/8-16 X 8 1/2	50	130
BC137090	BC437090	3/8-16 X 9	50	130

AUTRES DIMENSIONS DISPONIBLES/OTHER DIMENSIONS ARE AVAILABLE

BOULONS À TÊTE
 HEXAGONALE
 GRADE 2
 GROS FILETS

NOIR / BARE
 ZINC / PLATED

HEX HEAD
 CAP SCREWS
 GRADE 2
 NATIONAL COARSE

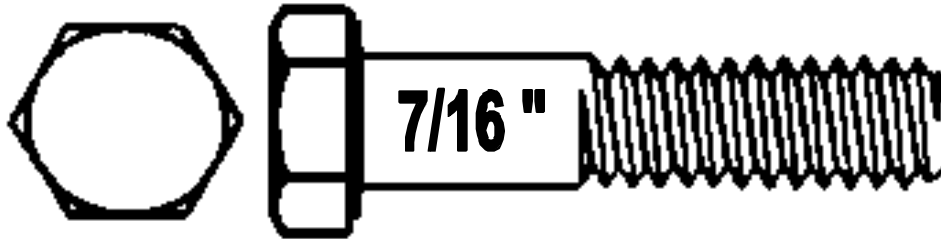

NOTRE CODE NOIR	NOTRE CODE ZINC	DESCRIPTION	QTÉ/BOITE	QTÉ/VRAC
OUR CODE BARE	OUR CODE PLATED	DESCRIPTION	QTY/BOX	QTY/BULK
BC143007	*****	7/16-14 X 3/4	50	750
BC143010	BC443010	7/16-14 X 1	50	650
BC143012	BC443012	7/16-14 X 1 1/4	50	550
BC143015	BC443015	7/16-14 X 1 1/2	50	500
BC143017	BC443017	7/16-14 X 1 3/4	50	450
BC143020	BC443020	7/16-14 X 2	50	400
BC143022	*****	7/16-14 X 2 1/4	50	350
BC143025	BC443025	7/16-14 X 2 1/2	50	300
BC143027	*****	7/16-14 X 2 3/4	50	300
BC143030	BC443030	7/16-14 X 3	50	275
BC143032	BC443032	7/16-14 X 3 1/4	50	250
BC143035	BC443035	7/16-14 X 3 1/2	50	225
BC143040	BC443040	7/16-14 X 4	50	200
BC143045	BC443045	7/16-14 X 4 1/2	50	175
BC143050	BC443050	7/16-14 X 5	50	150
BC143055	BC443055	7/16-14 X 5 1/2	50	150
BC143060	BC443060	7/16-14 X 6	50	125

AUTRES DIMENSIONS DISPONIBLES/OTHER DIMENSIONS ARE AVAILABLE



Tel.: (819) 346-2903 / (888) 345-2903 Fax.: (819) 346-3389

Email: distributeur@boulonsestrie.com

BOULONS À TÊTE
 HEXAGONALE
 GRADE 2
 GROS FILETS

NOIR / BARE
 ZINC / PLATED

HEX HEAD
 CAP SCREWS
 GRADE 2
 NATIONAL COARSE

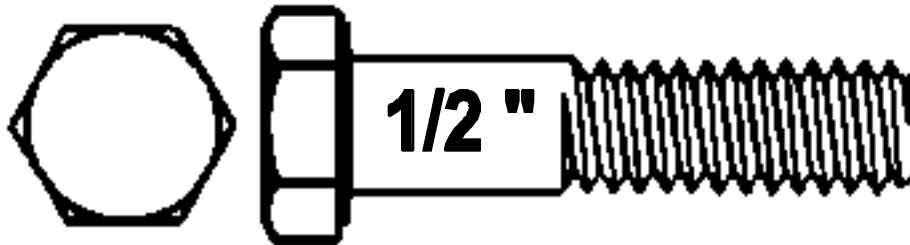

NOTRE CODE NOIR	NOTRE CODE ZINC	DESCRIPTION	QTÉ/BOITE	QTÉ/VRAC
OUR CODE BARE	OUR CODE PLATED	DESCRIPTION	QTY/BOX	QTY/BULK
BC150007	BC450007	1/2-13 X 3/4	50	475
BC150008	*****	1/2-13 X 7/8	50	450
BC150010	BC450010	1/2-13 X 1	50	400
BC150012	BC450012	1/2-13 X 1 1/4	50	375
BC150015	BC450015	1/2-13 X 1 1/2	50	300
BC150017	BC450017	1/2-13 X 1 3/4	50	275
BC150020	BC450020	1/2-13 X 2	50	250
BC150022	BC450022	1/2-13 X 2 1/4	50	225
BC150025	BC450025	1/2-13 X 2 1/2	50	225
BC150027	BC450027	1/2-13 X 2 3/4	50	200
BC150030	BC450030	1/2-13 X 3	50	200
BC150032	BC450032	1/2-13 X 3 1/4	50	175
BC150035	BC450035	1/2-13 X 3 1/2	50	150
BC150037	*****	1/2-13 X 3 3/4	50	150
BC150040	BC450040	1/2-13 X 4	50	150
BC150045	BC450045	1/2-13 X 4 1/2	50	125
BC150050	BC450050	1/2-13 X 5	50	125
BC150055	BC450055	1/2-13 X 5 1/2	25	100
BC150060	BC450060	1/2-13 X 6	25	100
BC150065	BC450065	1/2-13 X 6 1/2	25	100
BC150070	BC450070	1/2-13 X 7	25	90
*****	BC450075	1/2-13 X 7 1/2	25	80
BC150080	BC450080	1/2-13 X 8	25	80
BC150085	*****	1/2-13 X 8 1/2	25	80
BC150090	*****	1/2-13 X 9	25	75
*****	BC450095	1/2-13 X 9 1/2	-	70

AUTRES DIMENSIONS DISPONIBLES/OTHER DIMENSIONS ARE AVAILABLE

BOULONS À TÊTE
 HEXAGONALE
 GRADE 2
 GROS FILETS

NOIR / BARE
 ZINC / PLATED

HEX HEAD
 CAP SCREWS
 GRADE 2
 NATIONAL COARSE

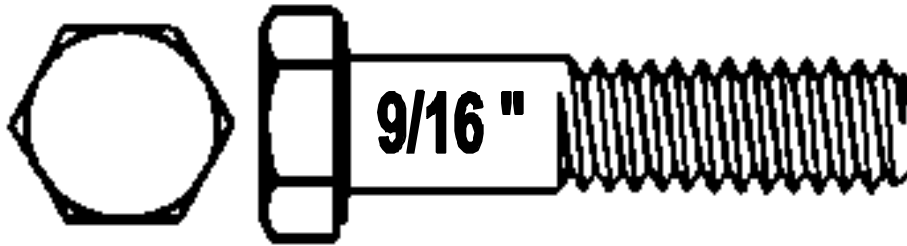

NOTRE CODE NOIR	NOTRE CODE ZINC	DESCRIPTION	QTÉ/BOITE	QTÉ/VRAC
OUR CODE BARE	OUR CODE PLATED	DESCRIPTION	QTY/BOX	QTY/BULK
*****	*****	9/16-12 X 1	-	350
*****	*****	9/16-12 X 1 1/4	-	300
BC156015	*****	9/16-12 X 1 1/2	25	275
*****	*****	9/16-12 X 1 3/4	-	250
BC156020	*****	9/16-12 X 2	25	225
*****	*****	9/16-12 X 2 1/4	25	200
BC156025	*****	9/16-12 X 2 1/2	25	175
BC156027	*****	9/16-12 X 2 3/4	25	150
BC156030	*****	9/16-12 X 3	25	150
*****	*****	9/16-12 X 3 1/4	25	125
*****	*****	9/16-12 X 3 1/2	25	125
BC156037	*****	9/16-12 X 3 3/4	25	125
BC156040	*****	9/16-12 X 4	25	100
BC156045	*****	9/16-12 X 4 1/2	25	100
*****	*****	9/16-12 X 5	25	100
*****	*****	9/16-12 X 5 1/2	25	75
*****	*****	9/16-12 X 6	25	75

AUTRES DIMENSIONS DISPONIBLES/OTHER DIMENSIONS ARE AVAILABLE



Tel.: (819) 346-2903 / (888) 345-2903 Fax.: (819) 346-3389

Email: distributeur@boulonsestrie.com

BOULONS À TÊTE
 HEXAGONALE
 GRADE 2
 GROS FILETS

NOIR / BARE
 ZINC / PLATED

HEX HEAD
 CAP SCREWS
 GRADE 2
 NATIONAL COARSE

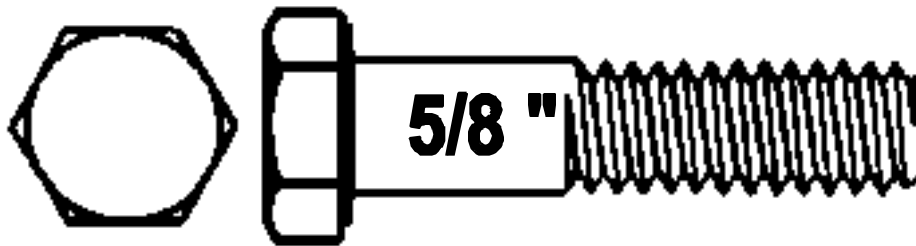

NOTRE CODE NOIR	NOTRE CODE ZINC	DESCRIPTION	QTÉ/BOITE	QTÉ/VRAC
OUR CODE BARE	OUR CODE PLATED	DESCRIPTION	QTY/BOX	QTY/BULK
BC162010	BC462010	5/8-11 X 1	25	250
BC162012	BC462012	5/8-11 X 1 1/4	25	225
BC162015	BC462015	5/8-11 X 1 1/2	25	200
BC162017	BC462017	5/8-11 X 1 3/4	25	175
BC162020	BC462020	5/8-11 X 2	25	175
BC162022	BC462022	5/8-11 X 2 1/4	25	175
BC162025	BC462025	5/8-11 X 2 1/2	25	125
BC162027	BC462027	5/8-11 X 2 3/4	25	125
BC162030	BC462030	5/8-11 X 3	25	100
BC162032	*****	5/8-11 X 3 1/4	25	100
BC162035	BC462035	5/8-11 X 3 1/2	25	100
BC162040	BC462040	5/8-11 X 4	25	90
BC162045	BC462045	5/8-11 X 4 1/2	25	80
BC162050	BC462050	5/8-11 X 5	25	75
BC162055	BC462055	5/8-11 X 5 1/2	25	70
BC162060	BC462060	5/8-11 X 6	25	65
BC162065	BC462065	5/8-11 X 6 1/2	25	60
BC162070	BC462070	5/8-11 X 7	25	55
BC162075	BC462075	5/8-11 X 7 1/2	25	55
BC162080	*****	5/8-11 X 8	25	50
BC162085	*****	5/8-11 X 8 1/2	-	50
BC162090	*****	5/8-11 X 9	-	45
BC162095	*****	5/8-11 X 9 1/2	-	45
*****	*****	5/8-11 X 10	-	40
*****	*****	5/8-11 X 11	-	40
*****	*****	5/8-11 X 12	-	35

AUTRES DIMENSIONS DISPONIBLES/OTHER DIMENSIONS ARE AVAILABLE

BOULONS À TÊTE
 HEXAGONALE
 GRADE 2
 GROS FILETS

NOIR / BARE
 ZINC / PLATED

HEX HEAD
 CAP SCREWS
 GRADE 2
 NATIONAL COARSE

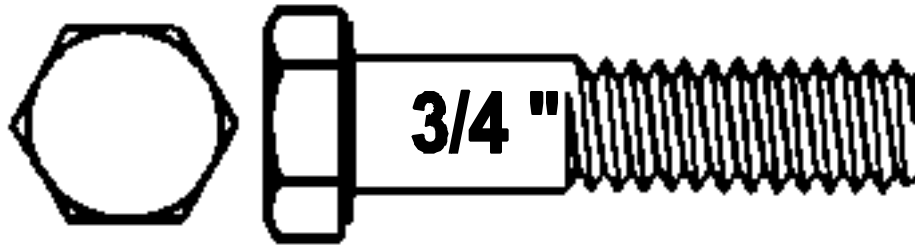

NOTRE CODE NOIR	NOTRE CODE ZINC	DESCRIPTION	QTÉ/BOITE	QTÉ/VRAC
OUR CODE BARE	OUR CODE PLATED	DESCRIPTION	QTY/BOX	QTY/BULK
BC175010	BC475010	3/4-10 X 1	20	150
BC175012	BC475012	3/4-10 X 1 1/4	20	140
BC175015	BC475015	3/4-10 X 1 1/2	20	125
BC175017	BC475017	3/4-10 X 1 3/4	20	120
BC175020	BC475020	3/4-10 X 2	20	100
BC175022	BC475022	3/4-10 X 2 1/4	20	100
BC175025	BC475025	3/4-10 X 2 1/2	20	90
BC175027	BC475027	3/4-10 X 2 3/4	20	85
BC175030	BC475030	3/4-10 X 3	20	80
BC175032	BC475032	3/4-10 X 3 1/4	20	75
BC175035	BC475035	3/4-10 X 3 1/2	20	70
BC175037	BC475037	3/4-10 X 3 3/4	20	65
BC175040	BC475040	3/4-10 X 4	20	60
BC175045	BC475045	3/4-10 X 4 1/2	20	55
BC175050	BC475050	3/4-10 X 5	20	45
BC175055	BC475055	3/4-10 X 5 1/2	20	45
BC175060	BC475060	3/4-10 X 6	20	40
BC175065	BC475065	3/4-10 X 6 1/2	20	40
BC175070	*****	3/4-10 X 7	20	35
BC175075	*****	3/4-10 X 7 1/2	20	35
BC175080	*****	3/4-10 X 8	20	35
*****	*****	3/4-10 X 8 1/2	-	30
BC175090	BC475090	3/4-10 X 9	20	30
*****	*****	3/4-10 X 9 1/2	-	30
*****	*****	3/4-10 X 10	-	30
*****	*****	3/4-10 X 11	-	25

AUTRES DIMENSIONS DISPONIBLES/OTHER DIMENSIONS ARE AVAILABLE

BOULONS À TÊTE
 HEXAGONALE
 GRADE 2
 GROS FILETS

NOIR / BARE
 ZINC / PLATED

HEX HEAD
 CAP SCREWS
 GRADE 2
 NATIONAL COARSE

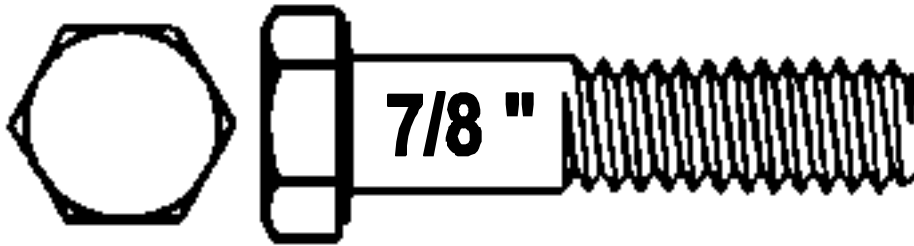

NOTRE CODE NOIR	NOTRE CODE ZINC	DESCRIPTION	QTÉ/BOITE	QTÉ/VRAC
OUR CODE BARE	OUR CODE PLATED	DESCRIPTION	QTY/BOX	QTY/BULK
BC187015	*****	7/8-9 X 1 1/2	20	85
BC187017	*****	7/8-9 X 1 3/4	20	80
BC187020	BC487020	7/8-9 X 2	20	75
BC187022	BC487022	7/8-9 X 2 1/4	20	70
BC187025	BC487025	7/8-9 X 2 1/2	20	65
*****	BC487027	7/8-9 X 2 3/4	20	60
BC187030	BC487030	7/8-9 X 3	20	55
BC187035	BC487035	7/8-9 X 3 1/2	20	50
BC187040	BC487040	7/8-9 X 4	20	45
BC187045	*****	7/8-9 X 4 1/2	20	40
BC187050	*****	7/8-9 X 5	20	35
*****	*****	7/8-9 X 5 1/2	10	35
BC187060	*****	7/8-9 X 6	10	30
*****	*****	7/8-9 X 6 1/2	10	30
*****	*****	7/8-9 X 7	10	25
*****	BC487075	7/8-9 X 7 1/2	-	25
*****	*****	7/8-9 X 8	-	25
*****	*****	7/8-9 X 9	-	23
*****	*****	7/8-9 X 10	-	20
*****	*****	7/8-9 X 11	-	19
*****	*****	7/8-9 X 12	-	17
BC187130	*****	7/8-9 X 13	-	16
*****	*****	7/8-9 X 14	-	15
*****	*****	7/8-9 X 15	-	VRAC/BULK
*****	*****	7/8-9 X 16	-	VRAC/BULK

AUTRES DIMENSIONS DISPONIBLES/OTHER DIMENSIONS ARE AVAILABLE

BOULONS À TÊTE
 HEXAGONALE
 GRADE 2
 GROS FILETS

NOIR / BARE
 ZINC / PLATED

HEX HEAD
 CAP SCREWS
 GRADE 2
 NATIONAL COARSE

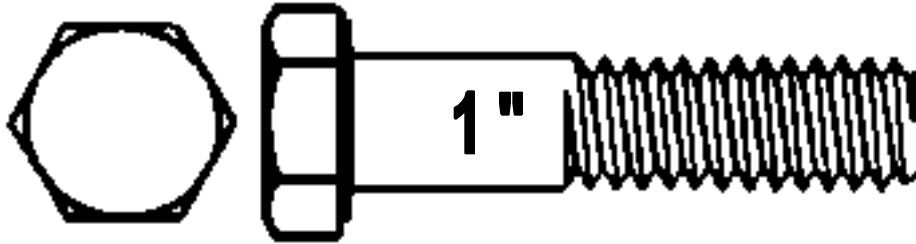

NOTRE CODE NOIR	NOTRE CODE ZINC	DESCRIPTION	QTÉ/BOITE	QTÉ/VRAC
OUR CODE BARE	OUR CODE PLATED	DESCRIPTION	QTY/BOX	QTY/BULK
BC190012	*****	1-8 X 1 1/4	20	55
BC190015	*****	1-8 X 1 1/2	20	55
BC190017	*****	1-8 X 1 3/4	20	55
BC190020	BC490020	1-8 X 2	20	50
*****	*****	1-8 X 2 1/4	20	50
BC190025	BC490025	1-8 X 2 1/2	20	45
BC190030	*****	1-8 X 3	20	40
BC190035	*****	1-8 X 3 1/2	10	35
BC190040	BC490040	1-8 X 4	10	35
BC190045	BC490045	1-8 X 4 1/2	10	30
BC190050	*****	1-8 X 5	10	25
BC190055	*****	1-8 X 5 1/2	10	25
BC190060	BC490060	1-8 X 6	10	25
BC190070	*****	1-8 X 7	10	20
BC190080	*****	1-8 X 8	10	18
*****	*****	1-8 X 9	-	15
*****	*****	1-8 X 10	-	15
*****	*****	1-8 X 11	-	15

AUTRES DIMENSIONS DISPONIBLES/OTHER DIMENSIONS ARE AVAILABLE



Tel.: (819) 346-2903 / (888) 345-2903 Fax.: (819) 346-3389
 Email: distributeur@boulonsestrie.com

BOULONS À TÊTE
 HEXAGONAL
 GRADE 2
 GROS FILETS

NOIR / BARE
 ZINC / PLATED

HEX HEAD
 CAP SCREWS
 GRADE 2
 NATIONAL COARSE

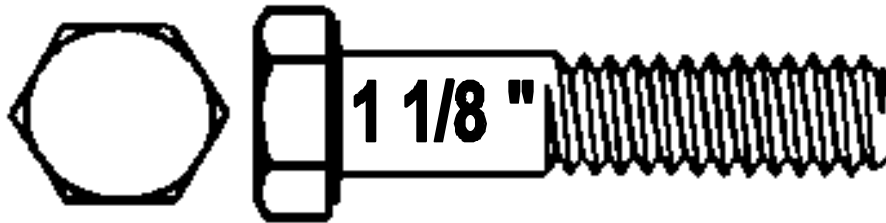

NOTRE CODE NOIR	NOTRE CODE ZINC	DESCRIPTION	QTÉ/BOITE	QTÉ/VRAC
OUR CODE BARE	OUR CODE PLATED	DESCRIPTION	QTY/BOX	QTY/BULK
BC191020	*****	1 1/8-7 X 2	-	15
BC191025	BC491025	1 1/8-7 X 2 1/2	-	35
BC191035	*****	1 1/8-7 X 3 1/2	-	30
BC191040	*****	1 1/8-7 X 4	-	25
BC191045	*****	1 1/8-7 X 4 1/2	-	20
BC191050	*****	1 1/8-7 X 5	-	20
BC191055	*****	1 1/8-7 X 5 1/2	-	20

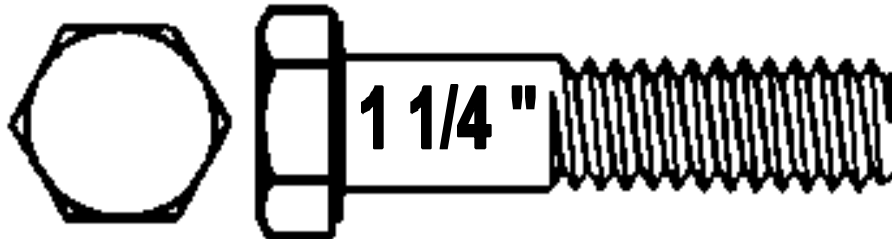

NOTRE CODE NOIR	NOTRE CODE ZINC	DESCRIPTION	QTÉ/BOITE	QTÉ/VRAC
OUR CODE BARE	OUR CODE PLATED	DESCRIPTION	QTY/BOX	QTY/BULK
*****	*****	1 1/4-7 X 2	-	30
*****	BC492030	1 1/4-7 X 3	-	25
*****	*****	1 1/4-7 X 4	-	20
BC192050	*****	1 1/4-7 X 5	-	15
*****	*****	1 1/4-7 X 6	-	15
*****	*****	1 1/4-7 X 7	-	10

AUTRES DIMENSIONS DISPONIBLES / OTHER DIMENSIONS ARE AVAILABLE



Tel.: (819) 346-2903 / (888) 345-2903 Fax.: (819) 346-3389

Email: distributeur@boulonsestrie.com

BOULONS À TÊTE
 HEXAGONAL
 GRADE 2
 GROS FILETS

NOIR / BARE
 ZINC / PLATED

HEX HEAD
 CAP SCREWS
 GRADE 2
 NATIONAL COARSE

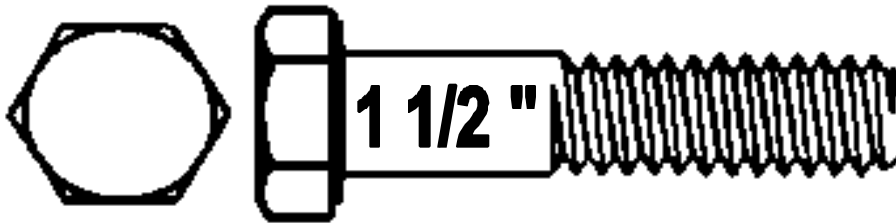

NOTRE CODE NOIR	NOTRE CODE ZINC	DESCRIPTION	QTÉ/BOITE	QTÉ/VRAC
OUR CODE BARE	OUR CODE PLATED	DESCRIPTION	QTY/BOX	QTY/BULK
*****	*****	1 1/2-6 X 3	-	15
BC195035	*****	1 1/2-6 X 3 1/2	-	15
*****	*****	1 1/2-6 X 4 1/2	-	12
*****	*****	1 1/2-6 X 5 1/2	-	10
*****	*****	1 1/2-6 X 6	-	10
*****	*****	1 1/2-6 X 6 1/2	-	9
BC195070	*****	1 1/2-6 X 7	-	9
BC195080	*****	1 1/2-6 X 8	-	8
*****	*****	1 1/2-6 X 10	-	6
*****	*****	1 1/2-6 X 12	-	

AUTRES DIMENSIONS DISPONIBLES / OTHER DIMENSIONS ARE AVAILABLE



Tel.: (819) 346-2903 / (888) 345-2903 Fax.: (819) 346-3389

Email: distributeur@boulonstrie.com

BOULONS À TÊTE
 HEXAGONALE
 GRADE 5
 GROS FILETS

NOIR / BARE
 ZINC / PLATED

HEX HEAD
 CAP SCREWS
 GRADE 5
 NATIONAL COARSE

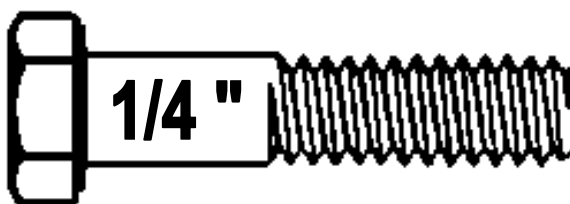

NOTRE CODE NOIR	NOTRE CODE ZINC	DESCRIPTION	QTÉ/BOITE	QTÉ/VRAC
OUR CODE BARE	OUR CODE PLATED	DESCRIPTION	QTY/BOX	QTY/BULK
BC225005	BC525005	1/4-20 X 1/2	100	3300
BC225006	BC525006	1/4-20 X 5/8	100	3000
BC225007	BC525007	1/4-20 X 3/4	100	2700
BC225008	BC525008	1/4-20 X 7/8	100	2500
BC225010	BC525010	1/4-20 X 1	100	2200
BC225012	BC525012	1/4-20 X 1 1/4	100	2000
BC225015	BC525015	1/4-20 X 1 1/2	100	1900
BC225017	BC525017	1/4-20 X 1 3/4	100	1400
BC225020	BC525020	1/4-20 X 2	100	1200
BC225022	BC525022	1/4-20 X 2 1/4	100	1000
BC225025	BC525025	1/4-20 X 2 1/2	100	900
BC225027	BC527027	1/4-20 X 2 3/4	100	750
BC225030	BC525030	1/4-20 X 3	100	750
BC225032	BC525032	1/4-20 X 3 1/4	100	600
BC225035	BC525035	1/4-20 X 3 1/2	100	550
BC225037	BC525037	1/4-20 X 3 3/4	100	500
BC225040	BC525040	1/4-20 X 4	100	450
BC225045	BC525045	1/4-20 X 4 1/2	100	450
BC225050	BC525050	1/4-20 X5	100	400
BC225055	BC525055	1/4-20 X 5 1/2	100	400
BC225060	BC525060	1/4-20 X 6	100	350
*****	BC525070	1/4-20 X 7	100	300

AUTRES DIMENSIONS DISPONIBLES / OTHER DIMENSIONS ARE AVAILABLE



Tel.: (819) 346-2903 / (888) 345-2903 Fax.: (819) 346-3389

Email: distributeur@boulonsestrie.com

BOULONS À TÊTE
 HEXAGONALE
 GRADE 5
 GROS FILETS

NOIR / BARE
 ZINC / PLATED

HEX HEAD
 CAP SCREWS
 GRADE 5
 NATIONAL COARSE

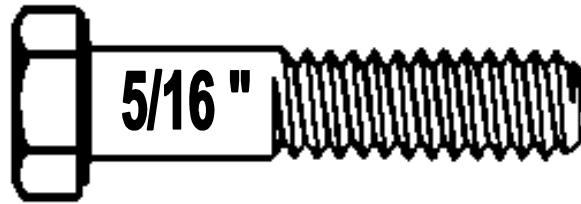

NOTRE CODE NOIR	NOTRE CODE ZINC	DESCRIPTION	QTÉ/BOITE	QTÉ/VRAC
OUR CODE BARE	OUR CODE PLATED	DESCRIPTION	QTY/BOX	QTY/BULK
BC231005	BC531005	5/16-18 X 1/2	100	1950
BC231006	BC531006	5/16-18 X 5/8	100	1800
BC231007	BC531007	5/16-18 X 3/4	100	1650
BC231008	BC531008	5/16-18 X 7/8	100	1500
BC231010	BC531010	5/16-18 X 1	100	1400
BC231012	BC531012	5/16-18 X 1 1/4	100	1100
BC231015	BC531015	5/16-18 X 1 1/2	100	1000
BC231017	BC531017	5/16-18 X 1 3/4	100	850
BC231020	BC531020	5/16-18 X 2	100	800
BC231022	BC531022	5/16-18 X 2 1/4	100	700
BC231025	BC531025	5/16-18 X 2 1/2	100	600
BC231027	BC531027	5/16-18 X 2 3/4	100	550
BC231030	BC531030	5/16-18 X 3	100	500
BC231032	BC531032	5/16-18 X 3 1/4	100	450
BC231035	BC531035	5/16-18 X 3 1/2	100	450
BC231037	BC531037	5/16-18 X 3 3/4	100	400
BC231040	BC531040	5/16-18 X 4	100	400
BC231045	BC531045	5/16-18 X 4 1/2	100	300
BC231050	BC531050	5/16-18 X 5	100	250
BC231055	BC531055	5/16-18 X 5 1/2	100	250
BC231060	BC531060	5/16-18 X 6	100	250
BC231080	BC531080	5/16-18 X 8	100	225

AUTRES DIMENSIONS DISPONIBLES / OTHER DIMENSIONS ARE AVAILABLE



Tel.: (819) 346-2903 / (888) 345-2903 Fax.: (819) 346-3389

Email: distributeur@boulonsestrie.com

A-14

BOULONS À TÊTE
HEXAGONALE
GRADE 5
GROS FILETS

NOIR / BARE
ZINC / PLATED

HEX HEAD
CAP SCREWS
GRADE 5
NATIONAL COARSE

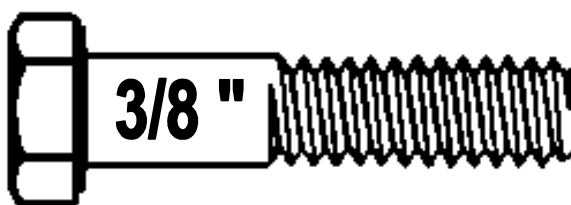

NOTRE CODE NOIR	NOTRE CODE ZINC	DESCRIPTION	QTÉ/BOITE	QTÉ/VRAC
OUR CODE BARE	OUR CODE PLATED	DESCRIPTION	QTY/BOX	QTY/BULK
BC237005	BC537005	3/8-16 X 1/2	100	1300
BC237006	BC537006	3/8-16 X 5/8	100	1200
BC237007	BC537007	3/8-16 X 3/4	100	1100
BC237008	BC537008	3/8-16 X 7/8	100	1000
BC237010	BC537010	3/8-16 X 1	100	900
BC237012	BC537012	3/8-16 X 1 1/4	100	800
BC237015	BC537015	3/8-16 X 1 1/2	100	675
BC237017	BC537017	3/8-16 X 1 3/4	100	600
BC237020	BC537020	3/8-16 X 2	100	550
BC237022	BC537022	3/8-16 X 2 1/4	100	450
BC237025	BC537025	3/8-16 X 2 1/2	100	400
BC237027	BC537027	3/8-16 X 2 3/4	100	400
BC237030	BC537030	3/8-16 X 3	100	325
BC237032	BC537032	3/8-16 X 3 1/4	100	325
BC237035	BC537035	3/8-16 X 3 1/2	100	300
BC237040	BC537040	3/8-16 X 4	100	250
BC237045	BC537045	3/8-16 X 4 1/2	100	225
BC237050	BC537050	3/8-16 X 5	100	225
BC237055	BC537055	3/8-16 X 5 1/2	100	175
BC237060	BC537060	3/8-16 X 6	100	175
BC237065	BC537065	3/8-16 X 6 1/2	50	175
BC237070	BC537070	3/8-16 X 7	50	150
BC237075	BC537075	3/8-16 X 7 1/2	50	150
BC237080	BC537080	3/8-16 X 8	50	150
BC237085	BC537085	3/8-16 X 8 1/2	-	130
BC237090	BC537090	3/8-16 X 9	-	130

AUTRES DIMENSIONS DISPONIBLES / OTHER DIMENSIONS ARE AVAILABLE



Tel.: (819) 346-2903 / (888) 345-2903 Fax.: (819) 346-3389

Email: distributeur@boulonstrie.com

BOULONS À TÊTE
 HEXAGONALE
 GRADE 5
 GROS FILETS

NOIR / BARE
 ZINC / PLATED

HEX HEAD
 CAP SCREWS
 GRADE 5
 NATIONAL COARSE

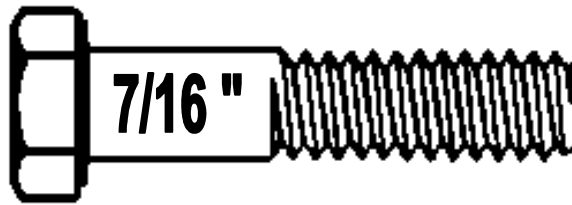

NOTRE CODE NOIR	NOTRE CODE ZINC	DESCRIPTION	QTÉ/BOITE	QTÉ/VRAC
OUR CODE BARE	OUR CODE PLATED	DESCRIPTION	QTY/BOX	QTY/BULK
BC243007	BC543007	7/16-14 X 3/4	50	750
BC243010	BC543010	7/16-14 X 1	50	650
BC243012	BC543012	7/16-14 X 1 1/4	50	550
BC243015	BC543015	7/16-14 X 1 1/2	50	500
BC243017	BC543017	7/16-14 X 1 3/4	50	450
BC243020	BC543020	7/16-14 X 2	50	400
BC243022	BC543022	7/16-14 X 2 1/4	50	350
BC243025	BC543025	7/16-14 X 2 1/2	50	300
BC243027	BC543027	7/16-14 X 2 3/4	50	300
BC243030	BC543030	7/16-14 X 3	50	275
BC243032	BC543032	7/16-14 X 3 1/4	50	250
BC243035	BC543035	7/16-14 X 3 1/2	50	225
BC243037	BC543037	7/16-14 X 3 3/4	50	225
BC243040	BC543040	7/16-14 X 4	50	200
BC243045	BC543045	7/16-14 X 4 1/2	50	175
BC243050	BC543050	7/16-14 X 5	50	150
BC243055	BC543055	7/16-14 X 5 1/2	50	150
BC243060	BC543060	7/16-14 X 6	50	125

AUTRES DIMENSIONS DISPONIBLES / OTHER DIMENSIONS ARE AVAILABLE



Tel.: (819) 346-2903 / (888) 345-2903 Fax.: (819) 346-3389

Email: distributeur@boulonsestrie.com

A-16

BOULONS À TÊTE
HEXAGONALE
GRADE 5
GROS FILETS

NOIR / BARE
ZINC / PLATED

HEX HEAD
CAP SCREWS
GRADE 5
NATIONAL COARSE

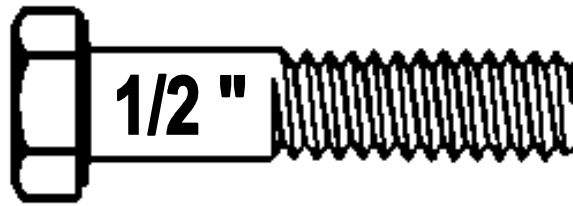

NOTRE CODE NOIR	NOTRE CODE ZINC	DESCRIPTION	QTÉ/BOITE	QTÉ/VRAC
OUR CODE BARE	OUR CODE PLATED	DESCRIPTION	QTY/BOX	QTY/BULK
BC250007	BC550007	1/2-13 X 3/4	50	475
BC250008	*****	1/2-13 X 7/8	50	450
BC250010	BC550010	1/2-13 X 1	50	400
BC250012	BC550012	1/2-13 X 1 1/4	50	375
BC250015	BC550015	1/2-13 X 1 1/2	50	300
BC250017	BC550017	1/2-13 X 1 3/4	50	275
BC250020	BC550020	1/2-13 X 2	50	250
BC250022	BC550022	1/2-13 X 2 1/4	50	225
BC250025	BC550025	1/2-13 X 2 1/2	50	225
BC250027	BC550027	1/2-13 X 2 3/4	50	200
BC250030	BC550030	1/2-13 X 3	50	200
BC250032	BC550032	1/2-13 X 3 1/4	50	175
BC250035	BC550035	1/2-13 X 3 1/2	50	150
BC250037	BC550037	1/2-13 X 3 3/4	50	150
BC250040	BC550040	1/2-13 X 4	50	150
BC250045	BC550045	1/2-13 X 4 1/2	50	125
BC250050	BC550050	1/2-13 X 5	50	125
BC250055	BC550055	1/2-13 X 5 1/2	50	100
BC250060	BC550060	1/2-13 X 6	50	100
BC250065	BC550065	1/2-13 X 6 1/2	50	100
BC250070	BC550070	1/2-13 X 7	50	90
BC250075	BC550075	1/2-13 X 7 1/2	25	80
BC250080	BC550080	1/2-13 X 8	25	80
*****	BC550085	1/2-13 X 8 1/2	-	80
BC250090	BC550090	1/2-13 X 9	-	75
BC250095	*****	1/2-13 X 9 1/2	-	70

AUTRES DIMENSIONS DISPONIBLES / OTHER DIMENSIONS ARE AVAILABLE



Tel.: (819) 346-2903 / (888) 345-2903 Fax.: (819) 346-3389

Email: distributeur@boulonsestrie.com

**BOULONS À TÊTE
HEXAGONALE
GRADE 5
GROS FILETS**

**NOIR / BARE
ZINC / PLATED**

**HEX HEAD
CAP SCREWS
GRADE 5
NATIONAL COARSE**

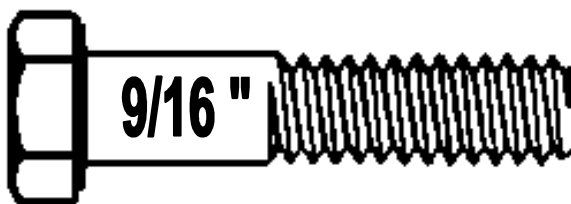

NOTRE CODE NOIR	NOTRE CODE ZINC	DESCRIPTION	QTÉ/BOITE	QTÉ/VRAC
OUR CODE BARE	OUR CODE PLATED	DESCRIPTION	QTY/BOX	QTY/BULK
BC256010	BC556010	9/16-12 X 1	25	350
BC256012	BC556012	9/16-12 X 1 1/4	25	300
BC256015	BC556015	9/16-12 X 1 1/2	25	275
BC256017	BC556017	9/16-12 X 1 3/4	25	250
BC256020	BC556020	9/16-12 X 2	25	225
BC256022	BC556022	9/16-12 X 2 1/4	25	200
BC256025	BC556025	9/16-12 X 2 1/2	25	175
BC256027	BC556027	9/16-12 X 2 3/4	25	150
BC256030	BC556030	9/16-12 X 3	25	150
*****	BC556032	9/16-12 X 3 1/4	25	125
BC256035	BC556035	9/16-12 X 3 1/2	25	125
*****	BC556037	9/16-12 X 3 3/4	25	125
BC256040	BC556040	9/16-12 X 4	25	100
BC256045	BC556045	9/16-12 X 4 1/2	25	100
BC256050	BC556050	9/16-12 X 5	25	100
BC256055	*****	9/16-12 X 5 1/2	25	75
BC256060	BC556060	9/16-12 X 6	25	75

AUTRES DIMENSIONS DISPONIBLES / OTHER DIMENSIONS ARE AVAILABLE



Tel.: (819) 346-2903 / (888) 345-2903 Fax.: (819) 346-3389

Email: distributeur@boulonsestrie.com

A-18

BOULONS À TÊTE
HEXAGONALE
GRADE 5
GROS FILETS

NOIR / BARE
ZINC / PLATED

HEX HEAD
CAP SCREWS
GRADE 5
NATIONAL COARSE

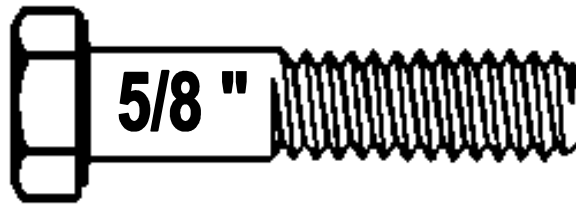

NOTRE CODE NOIR	NOTRE CODE ZINC	DESCRIPTION	QTÉ/BOITE	QTÉ/VRAC
OUR CODE BARE	OUR CODE PLATED	DESCRIPTION	QTY/BOX	QTY/BULK
BC262010	BC562010	5/8-11 X 1	25	250
BC262012	BC562012	5/8-11 X 1 1/4	25	225
BC262015	BC562015	5/8-11 X 1 1/2	25	200
BC262017	BC562017	5/8-11 X 1 3/4	25	175
BC262020	BC562020	5/8-11 X 2	25	175
BC262022	BC562022	5/8-11 X 2 1/4	25	175
BC262025	BC562025	5/8-11 X 2 1/2	25	125
BC262027	BC562027	5/8-11 X 2 3/4	25	125
BC262030	BC562030	5/8-11 X 3	25	100
BC262032	BC562032	5/8-11 X 3 1/4	25	100
BC262035	BC562035	5/8-11 X 3 1/2	25	100
BC262040	BC562040	5/8-11 X 4	25	90
BC262045	BC562045	5/8-11 X 4 1/2	25	80
BC262050	BC562050	5/8-11 X 5	25	75
BC262055	BC562055	5/8-11 X 5 1/2	25	70
BC262060	BC562060	5/8-11 X 6	25	65
BC262065	BC562065	5/8-11 X 6 1/2	25	60
BC262070	BC562070	5/8-11 X 7	25	55
BC262075	BC562075	5/8-11 X 7 1/2	-	55
BC262080	BC562080	5/8-11 X 8	-	50
BC262085	BC562085	5/8-11 X 8 1/2	-	50
BC262090	BC562090	5/8-11 X 9	-	45
*****	BC562095	5/8-11 X 9 1/2	-	45
BC262100	BC562100	5/8-11 X 10	-	40
BC262110	*****	5/8-11 X 11	-	40
BC262120	*****	5/8-11 X 12	-	35

AUTRES DIMENSIONS DISPONIBLES / OTHER DIMENSIONS ARE AVAILABLE



Tel.: (819) 346-2903 / (888) 345-2903 Fax.: (819) 346-3389

Email: distributeur@boulonsestrie.com

BOULONS À TÊTE
HEXAGONALE
GRADE 5
GROS FILETS

NOIR / BARE
ZINC / PLATED

HEX HEAD
CAP SCREWS
GRADE 5
NATIONAL COARSE

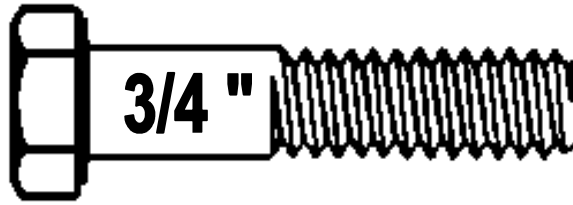

NOTRE CODE NOIR	NOTRE CODE ZINC	DESCRIPTION	QTÉ/BOITE	QTÉ/VRAC
OUR CODE BARE	OUR CODE PLATED	DESCRIPTION	QTY/BOX	QTY/BULK
BC275010	BC575010	3/4-10 X 1	20	150
BC275012	BC575012	3/4-10 X 1 1/4	20	140
BC275015	BC575015	3/4-10 X 1 1/2	20	125
BC275017	BC575017	3/4-10 X 1 3/4	20	120
BC275020	BC575020	3/4-10 X 2	20	100
BC275022	BC575022	3/4-10 X 2 1/4	20	100
BC275025	BC575025	3/4-10 X 2 1/2	20	90
BC275027	BC575027	3/4-10 X 2 3/4	20	85
BC275030	BC575030	3/4-10 X 3	20	80
BC275032	BC575032	3/4-10 X 3 1/4	20	75
BC275035	BC575035	3/4-10 X 3 1/2	20	70
BC275037	BC575037	3/4-10 X 3 3/4	20	65
BC275040	BC575040	3/4-10 X 4	20	60
BC275045	BC575045	3/4-10 X 4 1/2	20	55
BC275050	BC575050	3/4-10 X 5	20	45
*****	BC575055	3/4-10 X 5 1/2	20	45
BC275060	BC575060	3/4-10 X 6	20	40
BC275065	BC575065	3/4-10 X 6 1/2	20	40
BC275070	BC575070	3/4-10 X 7	20	35
BC275075	BC575075	3/4-10 X 7 1/2	20	35
BC275080	BC575080	3/4-10 X 8	20	35
BC275085	BC575085	3/4-10 X 8 1/2	20	30
BC275090	BC575090	3/4-10 X 9	-	30
BC275095	*****	3/4-10 X 9 1/2	-	30
BC275100	*****	3/4-10 X 10	-	30
*****	*****	3/4-10 X 11	-	25

AUTRES DIMENSIONS DISPONIBLES / OTHER DIMENSIONS ARE AVAILABLE



Tel.: (819) 346-2903 / (888) 345-2903 Fax.: (819) 346-3389

Email: distributeur@boulonsestrie.com

A-20

BOULONS À TÊTE
 HEXAGONALE
 GRADE 5
 GROS FILETS

NOIR / BARE
 ZINC / PLATED

HEX HEAD
 CAP SCREWS
 GRADE 5
 NATIONAL COARSE

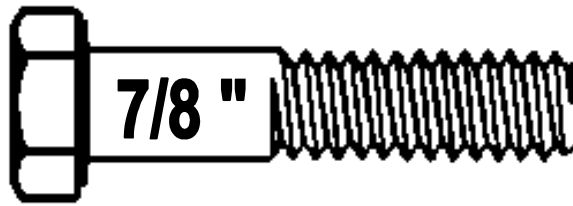
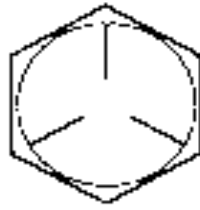

NOTRE CODE NOIR	NOTRE CODE ZINC	DESCRIPTION	QTÉ/BOITE	QTÉ/VRAC
OUR CODE BARE	OUR CODE PLATED	DESCRIPTION	QTY/BOX	QTY/BULK
BC287015	BC587015	7/8-9 X 1 1/2	20	85
BC287017	BC587017	7/8-9 X 1 3/4	20	80
BC287020	BC587020	7/8-9 X 2	20	75
BC287022	BC587022	7/8-9 X 2 1/4	20	70
BC287025	BC587025	7/8-9 X 2 1/2	20	65
BC287027	*****	7/8-9 X 2 3/4	20	60
BC287030	BC587030	7/8-9 X 3	20	55
BC287035	BC587035	7/8-9 X 3 1/2	20	50
BC287040	BC587040	7/8-9 X 4	20	45
BC287045	BC587045	7/8-9 X 4 1/2	20	40
BC287050	BC587050	7/8-9 X 5	20	35
BC287055	BC587055	7/8-9 X 5 1/2	10	35
BC287060	BC587060	7/8-9 X 6	10	30
BC287070	BC587070	7/8-9 X 7	10	25
BC287080	BC587080	7/8-9 X 8	10	25
BC287090	BC587090	7/8-9 X 9	-	23
BC287100	*****	7/8-9 X 10	-	20

AUTRES DIMENSIONS DISPONIBLES / OTHER DIMENSIONS ARE AVAILABLE



Tel.: (819) 346-2903 / (888) 345-2903 Fax.: (819) 346-3389

Email: distributeur@boulonsestrie.com

A-21

BOULONS À TÊTE
 HEXAGONALE
 GRADE 5
 GROS FILETS

NOIR / BARE
 ZINC / PLATED

HEX HEAD
 CAP SCREWS
 GRADE 5
 NATIONAL COARSE



NOTRE CODE NOIR	NOTRE CODE ZINC	DESCRIPTION	QTÉ/BOITE	QTÉ/VRAC
OUR CODE BARE	OUR CODE PLATED	DESCRIPTION	QTY/BOX	QTY/BULK
BC290015	*****	1-8 X 1 1/2	20	55
BC290017	BC590017	1-8 X 1 3/4	20	55
BC290020	BC590020	1-8 X 2	10	50
BC290022	BC590022	1-8 X 2 1/4	20	50
BC290025	BC590025	1-8 X 2 1/2	20	45
BC290027	BC590027	1-8 X 2 3/4	20	40
BC290030	BC590030	1-8 X 3	10	40
BC290035	BC590035	1-8 X 3 1/2	10	35
BC290040	BC590040	1-8 X 4	10	35
BC290045	BC590045	1-8 X 4 1/2	10	30
BC290050	BC590050	1-8 X 5	10	25
BC290055	BC590055	1-8 X 5 1/2	10	25
BC290060	BC590060	1-8 X 6	10	25
BC290070	BC590070	1-8 X 7	10	20
BC290080	BC590080	1-8 X 8	10	18
BC290090	BC590090	1-8 X 9	-	15
BC290100	BC590100	1-8 X 10	-	15
*****	BC590110	1-8 X 11	-	

AUTRES DIMENSIONS DISPONIBLES / OTHER DIMENSIONS ARE AVAILABLE



Tel.: (819) 346-2903 / (888) 345-2903 Fax.: (819) 346-3389

Email: distributeur@boulonsestrie.com

BOULONS À TÊTE
HEXAGONALE
GRADE 5
GROS FILETS

NOIR / BARE
ZINC / PLATED

HEX HEAD
CAP SCREWS
GRADE 5
NATIONAL COARSE

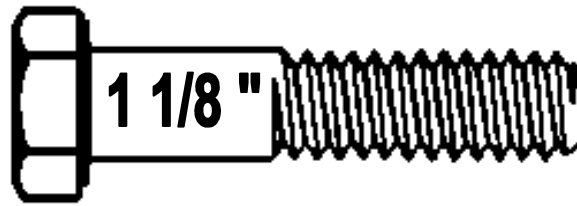

NOTRE CODE NOIR	NOTRE CODE ZINC	DESCRIPTION	QTÉ/BOITE	QTÉ/VRAC
OUR CODE BARE	OUR CODE PLATED	DESCRIPTION	QTY/BOX	QTY/BULK
BC291020	BC591020	1 1/8-7 X 2	10	15
BC291025	BC591025	1 1/8-7 X 2 1/2	10	35
BC291035	BC591035	1 1/8-7 X 3 1/2	10	30
BC291040	BC591040	1 1/8-7 X 4	10	25
BC291045	BC591045	1 1/8-7 X 4 1/2	10	20
BC291050	*****	1 1/8-7 X 5	10	20
BC291055	*****	1 1/8-7 X 5 1/2	10	20

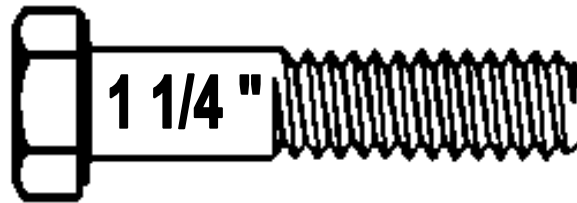
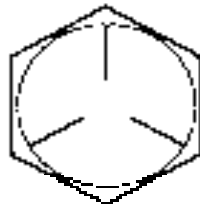

NOTRE CODE NOIR	NOTRE CODE ZINC	DESCRIPTION	QTÉ/BOITE	QTÉ/VRAC
OUR CODE BARE	OUR CODE PLATED	DESCRIPTION	QTY/BOX	QTY/BULK
BC292020	*****	1 1/4-7 X 2	10	30
BC292030	BC592030	1 1/4-7 X 3	10	25
BC292040	BC592040	1 1/4-7 X 4	10	20
BC292045	BC592045	1 1/4-7 X 4 1/2	5	-
BC292050	BC592050	1 1/4-7 X 5	5	-
BC292055	BC592055	1 1/4-7 X 5 1/2	5	15
BC292060	BC592060	1 1/4-7 X 6	5	15
BC292065	BC592080	1 1/4-7 X 6 1/2	5	-
BC292080	BC592080	1 1/4-7 X 8	-	10
BC292090	BC592090	1 1/4-7 X 9	-	-

AUTRES DIMENSIONS DISPONIBLES / OTHER DIMENSIONS ARE AVAILABLE



Tel.: (819) 346-2903 / (888) 345-2903 Fax.: (819) 346-3389

Email: distributeur@boulonsestrie.com

**BOULONS À TÊTE
HEXAGONALE
GRADE 5
GROS FILETS**

**NOIR / BARE
ZINC / PLATED**

**HEX HEAD
CAP SCREWS
GRADE 5
NATIONAL COARSE**

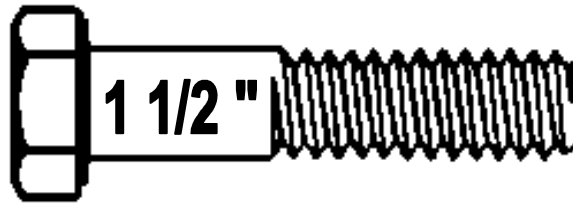

NOTRE CODE NOIR	NOTRE CODE ZINC	DESCRIPTION	QTÉ/BOITE	QTÉ/VRAC
OUR CODE BARE	OUR CODE PLATED	DESCRIPTION	QTY/BOX	QTY/BULK
BC295030	BC595030	1 1/2-6 X 3	5	15
BC295035	BC595035	1 1/2-6 X 3 1/2	5	15
BC295040	BC595040	1 1/2-6 X 4	5	12
BC295045	BC595045	1 1/2-6 X 4 1/2	5	12
BC295050	BC595050	1/2-6 X 5	-	11
BC295055	BC595055	1 1/2-6 X 5 1/2	-	10
BC295060	BC595060	1 1/2-6 X 6	-	10
BC295065	BC595065	1 1/2-6 X 6 1/2	-	9
*****	BC595070	1 1/2-6 X 7	-	9
BC295080	BC595080	1 1/2-6 X 8	-	8
*****	BC595090	1 1/2-6 X 9	-	10

AUTRES DIMENSIONS DISPONIBLES / OTHER DIMENSIONS ARE AVAILABLE



Tel.: (819) 346-2903 / (888) 345-2903 Fax.: (819) 346-3389

Email: distributeur@boulonsestrie.com

A-24

BOULONS À TÊTE
HEXAGONALE
GRADE 8
GROS FILETS

NOIR / BARE
ZINC / PLATED

HEX HEAD
CAP SCREWS
GRADE 8
NATIONAL COARSE

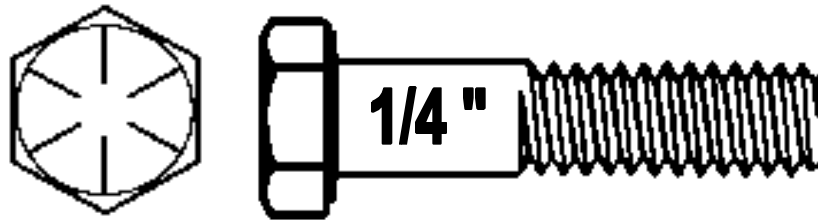

NOTRE CODE NOIR	NOTRE CODE ZINC	DESCRIPTION	QTÉ/BOÎTE	QTÉ/VRAC
OUR CODE BARE	OUR CODE PLATED	DESCRIPTION	QTY/BOX	QTY/BULK
BC325005	BC625005	1/4-20 X 1/2	100	3300
BC325007	BC625007	1/4-20 X 3/4	100	2700
BC325010	BC625010	1/4-20 X 1	100	2200
BC325012	BC625012	1/4-20 X 1 1/4	100	1900
BC325014	*****	1/4-20 X 1 3/8	100	1600
BC325015	BC625015	1/4-20 X 1 1/2	100	1900
BC325017	BC625017	1/4-20 X 1 3/4	100	1400
BC325020	BC625020	1/4-20 X 2	100	1200
BC325022	BC625022	1/4-20 X 2 1/4	100	1000
BC325025	BC625025	1/4-20 X 2 1/2	100	900
BC325027	BC625027	1/4-20 X 2 3/4	100	750
BC325030	BC625030	1/4-20 X 3	100	750
BC325032	*****	1/4-20 X 3 1/4	100	600
BC325035	BC625035	1/4-20 X 3 1/2	100	550
BC325037	*****	1/4-20 X 3 3/4	100	500
BC325040	BC625040	1/4-20 X 4	100	450
BC325045	*****	1/4-20 X 4 1/2	100	450
BC325050	*****	1/4-20 X 5	100	400
BC325055	*****	1/4-20 X 5 1/2	100	400
BC325060	*****	1/4-20 X 6	100	350
BC325065	*****	1/4-20 X 6 1/2	100	350

AUTRES DIMENSIONS DISPONIBLES / OTHER DIMENSIONS ARE AVAILABLE



Tel.: (819) 346-2903 / (888) 345-2903 Fax.: (819) 346-3389

Email: distributeur@boulonsestrie.com

BOULONS À TÊTE
HEXAGONALE
GRADE 8
GROS FILETS

NOIR / BARE
ZINC / PLATED

HEX HEAD
CAP SCREWS
GRADE 8
NATIONAL COARSE

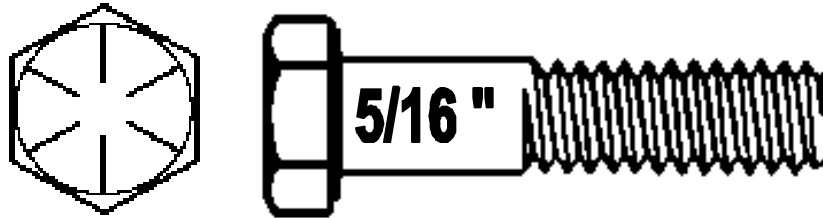

NOTRE CODE NOIR	NOTRE CODE ZINC	DESCRIPTION	QTÉ/BOÎTE	QTÉ/VRAC
OUR CODE BARE	OUR CODE PLATED	DESCRIPTION	QTY/BOX	QTY/BULK
BC331005	*****	5/16-18 X 1/2	100	1950
BC331007	BC631007	5/16-18 X 3/4	100	1650
*****	BC631008	5/16-18 X 7/8	100	1500
BC331010	BC631010	5/16-18 X 1	100	1400
BC331012	BC631012	5/16-18 X 1 1/4	100	1100
BC331015	BC631015	5/16-18 X 1 1/2	100	1000
BC331017	BC631017	5/16-18 X 1 3/4	100	850
BC331020	BC631020	5/16-18 X 2	100	800
BC331022	BC631022	5/16-18 X 2 1/4	100	700
BC331025	BC631025	5/16-18 X 2 1/2	100	600
BC331027	*****	5/16-18 X 2 3/4	100	550
BC331030	BC631030	5/16-18 X 3	100	500
BC331032	BC631032	5/16-18 X 3 1/4	100	450
BC331035	BC631035	5/16-18 X 3 1/2	100	450
BC331040	BC631040	5/16-18 X 4	100	400
BC331045	BC631045	5/16-18 X 4 1/2	100	300
BC331050	BC631050	5/16-18 X 5	100	250
BC331055	*****	5/16-18 X 5 1/2	100	250
BC331060	*****	5/16-18 X 6	100	250

AUTRES DIMENSIONS DISPONIBLES / OTHER DIMENSIONS ARE AVAILABLE



Tel.: (819) 346-2903 / (888) 345-2903 Fax.: (819) 346-3389

Email: distributeur@boulonstrie.com

BOULONS À TÊTE
 HEXAGONALE
 GRADE 8
 GROS FILETS

NOIR / BARE
 ZINC / PLATED

HEX HEAD
 CAP SCREWS
 GRADE 8
 NATIONAL COARSE

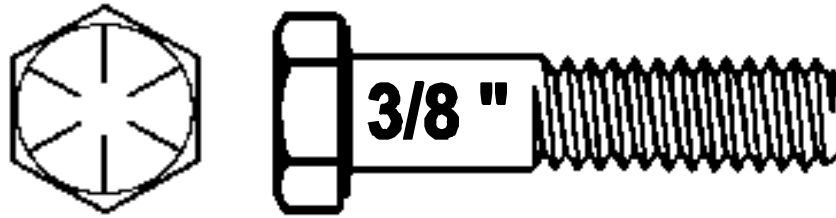

NOTRE CODE NOIR	NOTRE CODE ZINC	DESCRIPTION	QTÉ/BOÎTE	QTÉ/VRAC
OUR CODE BARE	OUR CODE PLATED	DESCRIPTION	QTY/BOX	QTY/BULK
BC337005	BC637005	3/8-16 X 1/2	100	1300
*****	BC637006	3/8-16 X 5/8	100	1200
BC337007	BC637007	3/8-16 X 3/4	100	1100
BC337010	BC637010	3/8-16 X 1	100	900
BC337012	BC637012	3/8-16 X 1 1/4	100	800
BC337015	BC637015	3/8-16 X 1 1/2	100	675
BC337017	BC637017	3/8-16 X 1 3/4	100	600
BC337020	BC637020	3/8-16 X 2	100	550
BC337022	BC637022	3/8-16 X 2 1/4	100	450
BC337025	BC637025	3/8-16 X 2 1/2	100	400
BC337027	BC637027	3/8-16 X 2 3/4	100	400
BC337030	BC637030	3/8-16 X 3	100	325
BC337032	BC637032	3/8-16 X 3 1/4	100	325
BC337035	BC637035	3/8-16 X 3 1/2	100	300
BC337040	BC637040	3/8-16 X 4	100	250
BC337045	BC637045	3/8-16 X 4 1/2	100	225
BC337047	*****	3/8-16 X 4 3/4	100	225
BC337050	BC637050	3/8-16 X 5	100	225
BC337055	*****	3/8-16 X 5 1/2	100	175
BC337060	BC637060	3/8-16 X 6	100	175
*****	*****	3/8-16 X 6 1/2	-	175

AUTRES DIMENSIONS DISPONIBLES / OTHER DIMENSIONS ARE AVAILABLE



Tel.: (819) 346-2903 / (888) 345-2903 Fax.: (819) 346-3389

Email: distributeur@boulonsestrie.com

BOULONS À TÊTE
 HEXAGONALE
 GRADE 8
 GROS FILETS

NOIR / BARE
 ZINC / PLATED

HEX HEAD
 CAP SCREWS
 GRADE 8
 NATIONAL COARSE

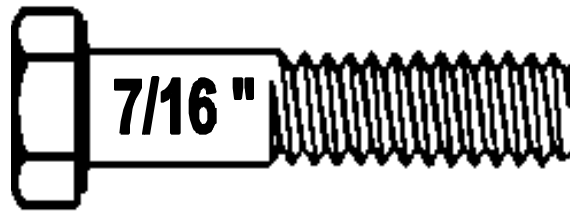
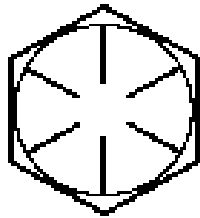

NOTRE CODE NOIR	NOTRE CODE ZINC	DESCRIPTION	QTÉ/BOÎTE	QTÉ/VRAC
OUR CODE BARE	OUR CODE PLATED	DESCRIPTION	QTY/BOX	QTY/BULK
BC343007	*****	7/16-14 X 3/4	50	750
BC343010	BC643010	7/16-14 X 1	50	650
BC343012	BC643012	7/16-14 X 1 1/4	50	550
BC343015	BC643015	7/16-14 X 1 1/2	50	500
BC343017	*****	7/16-14 X 1 3/4	50	450
BC343020	BC643020	7/16-14 X 2	50	400
BC343022	*****	7/16-14 X 2 1/4	50	350
BC343025	BC643025	7/16-14 X 2 1/2	50	300
BC343027	*****	7/16-14 X 2 3/4	50	300
BC343030	BC643030	7/16-14 X 3	50	275
BC343032	*****	7/16-14 X 3 1/4	50	250
BC343035	BC643035	7/16-14 X 3 1/2	50	225
BC343040	BC643040	7/16-14 X 4	50	200
BC343045	BC643045	7/16-14 X 4 1/2	50	175
BC343050	BC643050	7/16-14 X 5	50	150
*****	*****	7/16-14 X 5 1/2	50	150
BC343060	*****	7/16-14 X 6	50	125

AUTRES DIMENSIONS DISPONIBLES / OTHER DIMENSIONS ARE AVAILABLE



Tel.: (819) 346-2903 / (888) 345-2903 Fax.: (819) 346-3389

Email: distributeur@boulonsestrie.com

BOULONS À TÊTE
 HEXAGONALE
 GRADE 8
 GROS FILETS

NOIR / BARE
 ZINC / PLATED

HEX HEAD
 CAP SCREWS
 GRADE 8
 NATIONAL COARSE

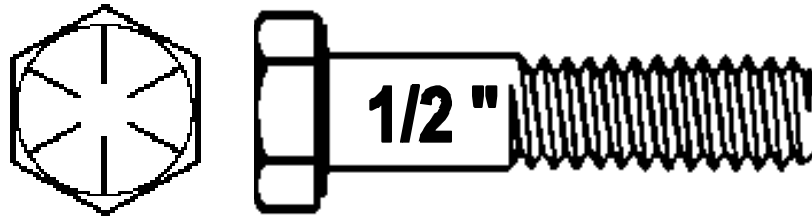

NOTRE CODE NOIR	NOTRE CODE ZINC	DESCRIPTION	QTÉ/BOÎTE	QTÉ/VRAC
OUR CODE BARE	OUR CODE PLATED	DESCRIPTION	QTY/BOX	QTY/BULK
BC350007	BC650007	1/2-13 X 3/4	50	475
BC350010	BC650010	1/2-13 X 1	50	400
BC350012	BC650012	1/2-13 X 1 1/4	50	375
BC350015	BC650015	1/2-13 X 1 1/2	50	300
BC350017	BC650017	1/2-13 X 1 3/4	50	275
BC350020	BC650020	1/2-13 X 2	50	250
BC350022	BC650022	1/2-13 X 2 1/4	50	225
BC350025	BC650025	1/2-13 X 2 1/2	50	225
BC350027	BC650027	1/2-13 X 2 3/4	50	200
BC350030	BC650030	1/2-13 X 3	50	200
BC350032	BC650032	1/2-13 X 3 1/4	50	175
BC350035	BC650035	1/2-13 X 3 1/2	50	150
*****	BC650037	1/2-13 X 3 3/4	50	150
BC350040	BC650040	1/2-13 X 4	50	150
BC350045	BC650045	1/2-13 X 4 1/2	50	125
BC350050	BC650050	1/2-13 X 5	50	125
BC350055	BC650055	1/2-13 X 5 1/2	25	100
BC350060	BC650060	1/2-13 X 6	25	100
BC350065	BC650065	1/2-13 X 6 1/2	25	100
BC350070	BC650070	1/2-13 X 7	25	90
*****	*****	1/2-13 X 7 1/2	-	80
BC350080	*****	1/2-13 X 8	25	80

AUTRES DIMENSIONS DISPONIBLES / OTHER DIMENSIONS ARE AVAILABLE



Tel.: (819) 346-2903 / (888) 345-2903 Fax.: (819) 346-3389

Email: distributeur@boulonsestrie.com

BOULONS À TÊTE
HEXAGONALE
GRADE 8
GROS FILETS

NOIR / BARE
ZINC / PLATED

HEX HEAD
CAP SCREWS
GRADE 8
NATIONAL COARSE

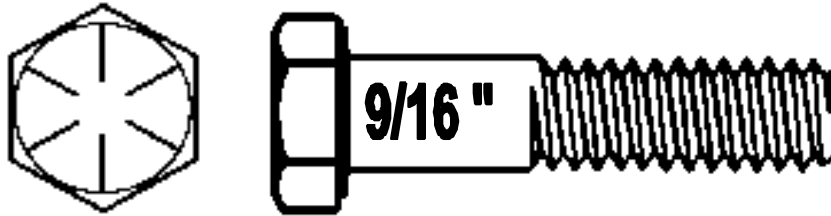

NOTRE CODE NOIR	NOTRE CODE ZINC	DESCRIPTION	QTÉ/BOÎTE	QTÉ/VRAC
OUR CODE BARE	OUR CODE PLATED	DESCRIPTION	QTY/BOX	QTY/BULK
BC356010	BC656010	9/16-12 X 1	25	350
*****	*****	9/16-12 X 1 1/4	25	300
BC356015	*****	9/16-12 X 1 1/2	25	275
BC356017	*****	9/16-12 X 1 3/4	25	250
BC356020	BC656020	9/16-12 X 2	25	225
BC356022	BC656022	9/16-12 X 2 1/4	25	200
BC356025	BC656025	9/16-12 X 2 1/2	25	175
BC356027	*****	9/16-12 X 2 3/4	25	150
BC356030	*****	9/16-12 X 3	25	150
BC356035	*****	9/16-12 X 3 1/2	25	125
BC356037	*****	9/16-12 X 3 3/4	25	125
BC356040	*****	9/16-12 X 4	25	100
BC356045	*****	9/16-12 X 4 1/2	25	100
BC356050	BC656050	9/16-12 X 5	25	100
BC356055	*****	9/16-12 X 5 1/2	25	75
BC356060	BC656060	9/16-12 X 6	25	75

AUTRES DIMENSIONS DISPONIBLES / OTHER DIMENSIONS ARE AVAILABLE



Tel.: (819) 346-2903 / (888) 345-2903 Fax.: (819) 346-3389

Email: distributeur@boulonsestrie.com

BOULONS À TÊTE
HEXAGONALE
GRADE 8
GROS FILETS

NOIR / BARE
ZINC / PLATED

HEX HEAD
CAP SCREWS
GRADE 8
NATIONAL COARSE

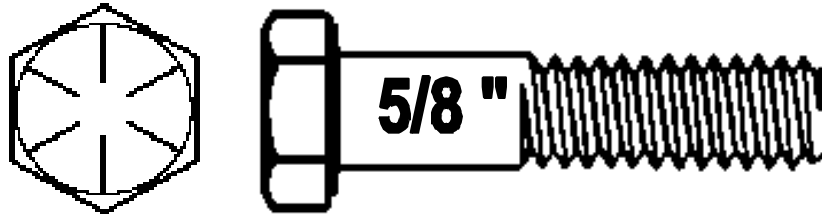

NOTRE CODE NOIR	NOTRE CODE ZINC	DESCRIPTION	QTÉ/BOÎTE	QTÉ/VRAC
OUR CODE BARE	OUR CODE PLATED	DESCRIPTION	QTY/BOX	QTY/BULK
BC362010	BC662010	5/8-11 X 1	25	250
BC362012	BC662012	5/8-11 X 1 1/4	25	225
BC362015	BC662015	5/8-11 X 1 1/2	25	200
BC362017	BC662017	5/8-11 X 1 3/4	25	175
BC362020	BC662020	5/8-11 X 2	25	175
BC362022	BC662022	5/8-11 X 2 1/4	25	175
BC362025	BC662025	5/8-11 X 2 1/2	25	125
BC362027	BC662027	5/8-11 X 2 3/4	25	125
BC362030	BC662030	5/8-11 X 3	25	100
BC362032	BC662032	5/8-11 X 3 1/4	25	100
BC362035	BC662035	5/8-11 X 3 1/2	25	100
BC362040	BC662040	5/8-11 X 4	25	90
BC362045	BC662045	5/8-11 X 4 1/2	25	80
BC362050	BC662050	5/8-11 X 5	25	75
BC362055	BC662055	5/8-11 X 5 1/2	25	70
BC362060	BC662060	5/8-11 X 6	25	65
BC362065	BC662065	5/8-11 X 6 1/2	25	60
BC362070	BC662070	5/8-11 X 7	25	55
BC362080	BC662080	5/8-11 X 8	-	50
BC362100	*****	5/8-11 X 10	-	40
BC362120	*****	5/8-11 X 12	-	35

AUTRES DIMENSIONS DISPONIBLES / OTHER DIMENSIONS ARE AVAILABLE



Tel.: (819) 346-2903 / (888) 345-2903 Fax.: (819) 346-3389

Email: distributeur@boulonstrie.com

BOULONS À TÊTE
 HEXAGONALE
 GRADE 8
 GROS FILETS

NOIR / BARE
 ZINC / PLATED

HEX HEAD
 CAP SCREWS
 GRADE 8
 NATIONAL COARSE

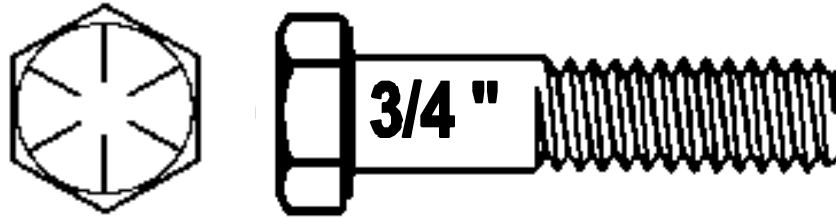

NOTRE CODE NOIR	NOTRE CODE ZINC	DESCRIPTION	QTÉ/BOÎTE	QTÉ/VRAC
OUR CODE BARE	OUR CODE PLATED	DESCRIPTION	QTY/BOX	QTY/BULK
BC375010	BC675010	3/4-10 X 1	20	150
BC375012	*****	3/4-10 X 1 1/4	20	140
BC375015	BC675015	3/4-10 X 1 1/2	20	125
BC375017	BC675017	3/4-10 X 1 3/4	20	120
BC375020	BC675020	3/4-10 X 2	20	100
BC375022	BC675022	3/4-10 X 2 1/4	20	100
BC375025	BC675025	3/4-10 X 2 1/2	20	90
BC375027	BC675027	3/4-10 X 2 3/4	20	85
BC375030	BC675030	3/4-10 X 3	20	80
BC375032	*****	3/4-10 X 3 1/4	20	75
BC375035	BC675035	3/4-10 X 3 1/2	20	70
BC375037	*****	3/4-10 X 3 3/4	20	65
BC375040	BC675040	3/4-10 X 4	20	60
BC375045	BC675045	3/4-10 X 4 1/2	20	55
BC375047	*****	3/4-10 X 4 3/4	20	50
BC375050	BC675050	3/4-10 X 5	20	45
BC375055	BC675055	3/4-10 X 5 1/2	20	45
BC375060	BC675060	3/4-10 X 6	20	40
BC375065	BC675065	3/4-10 X 6 1/2	20	40
BC375070	BC675070	3/4-10 X 7	20	35
*****	BC675075	3/4-10 X 7 1/2	-	35
BC375080	BC675080	3/4-10 X 8	-	35
BC375085	BC675085	3/4-10 X 8 1/2	-	30
BC375090	BC675090	3/4-10 X 9		
BC375100	BC675100	3/4-10 X 10		

AUTRES DIMENSIONS DISPONIBLES / OTHER DIMENSIONS ARE AVAILABLE

BOULONS À TÊTE
HEXAGONALE
GRADE 8
GROS FILETS

NOIR / BARE
ZINC / PLATED

HEX HEAD
CAP SCREWS
GRADE 8
NATIONAL COARSE

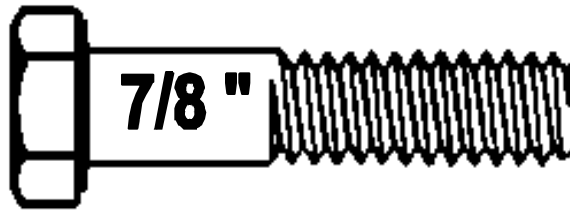

NOTRE CODE NOIR	NOTRE CODE ZINC	DESCRIPTION	QTÉ/BOÎTE	QTÉ/VRAC
OUR CODE BARE	OUR CODE PLATED	DESCRIPTION	QTY/BOX	QTY/BULK
BC387015	*****	7/8-9 X 1 1/2	20	85
BC387017	*****	7/8-9 X 1 3/4	20	80
BC387020	BC687020	7/8-9 X 2	20	75
BC387022	*****	7/8-9 X 2 1/4	20	70
BC387025	BC687025	7/8-9 X 2 1/2	20	65
BC387027	*****	7/8-9 X 2 3/4	20	60
BC387030	BC687030	7/8-9 X 3	20	55
BC387035	BC687035	7/8-9 X 3 1/2	20	50
BC387040	BC687040	7/8-9 X 4	15	45
BC387045	BC687045	7/8-9 X 4 1/2	15	40
BC387050	BC687050	7/8-9 X 5	15	35
BC387055	BC687055	7/8-9 X 5 1/2	15	35
BC387060	BC687060	7/8-9 X 6	15	30
BC387070	*****	7/8-9 X 7	10	25
BC387080	*****	7/8-9 X 8	-	25
BC387090	*****	7/8-9 X 9	-	23
BC387100	*****	7/8-9 X 10	-	20
BC387120	*****	7/8-9 X 12	-	17

AUTRES DIMENSIONS DISPONIBLES / OTHER DIMENSIONS ARE AVAILABLE



Tel.: (819) 346-2903 / (888) 345-2903 Fax.: (819) 346-3389

Email: distributeur@boulonsestrie.com

BOULONS À TÊTE
 HEXAGONALE
 GRADE 8
 GROS FILETS

NOIR / BARE
 ZINC / PLATED

HEX HEAD
 CAP SCREWS
 GRADE 8
 NATIONAL COARSE

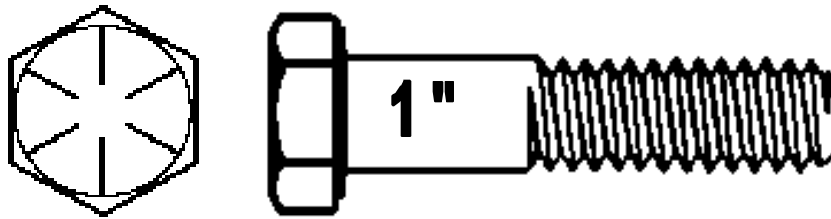

NOTRE CODE NOIR	NOTRE CODE ZINC	DESCRIPTION	QTÉ/BOÎTE	QTÉ/VRAC
OUR CODE BARE	OUR CODE PLATED	DESCRIPTION	QTY/BOX	QTY/BULK
BC390015	BC690015	1-8 X 1 1/2	20	55
BC390017	*****	1-8 X 1 3/4	20	55
BC390020	BC690020	1-8 X 2	20	50
BC390025	*****	1-8 X 2 1/2	20	45
BC390027	BC690027	1-8 X 2 3/4	20	40
BC390030	BC690030	1-8 X 3	10	40
BC390035	BC690035	1-8 X 3 1/2	10	35
BC390037	*****	1-8 X 3 3/4	10	35
BC390040	BC690040	1-8 X 4	10	35
BC390045	BC690045	1-8 X 4 1/2	10	30
BC390050	BC690050	1-8 X 5	10	25
BC390055	BC690055	1-8 X 5 1/2	10	25
BC390060	BC690060	1-8 X 6	10	25
BC390065	*****	1-8 X 6 1/2	10	20
BC390070	BC690070	1-8 X 7	10	20
BC390075	*****	1-8 X 7 1/2	-	20
BC390080	BC690080	1-8 X 8	-	18
BC390085	*****	1-8 X 8 1/2	-	18
BC390090	BC690090	1-8 X 9	-	15
BC390095	*****	1-8 X 9 1/2	-	15
BC390100	*****	1-8 X 10	-	15
*****	*****	1-8 X 15	-	-

AUTRES DIMENSIONS DISPONIBLES / OTHER DIMENSIONS ARE AVAILABLE



Tel.: (819) 346-2903 / (888) 345-2903 Fax.: (819) 346-3389

Email: distributeur@boulonsestrie.com

BOULONS À TÊTE
 HEXAGONALE
 GRADE 8
 GROS FILETS

NOIR / BARE
 ZINC / PLATED

HEX HEAD
 CAP SCREWS
 GRADE 8
 NATIONAL COARSE

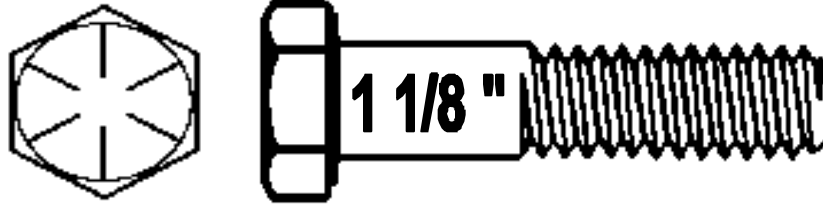

NOTRE CODE NOIR	NOTRE CODE ZINC	DESCRIPTION	QTÉ/BOÎTE	QTÉ/VRAC
OUR CODE BARE	OUR CODE PLATED	DESCRIPTION	QTY/BOX	QTY/BULK
BC391030	*****	1 1/8-7 X 3	-	30
BC391040	BC691040	1 1/8-7 X 4	-	25
BC391045	*****	1 1/8-7 X 4 1/2	-	20
BC391050	BC691050	1 1/8-7 X 5	-	20
BC391055	*****	1 1/8-7 X 5 1/2	-	20
BC391065	*****	1 1/8-7 X 6 1/2	-	15
BC391080	BC691080	1 1/8-7 X 8	-	15
BC391090	*****	1 1/8-7 X 9	-	13

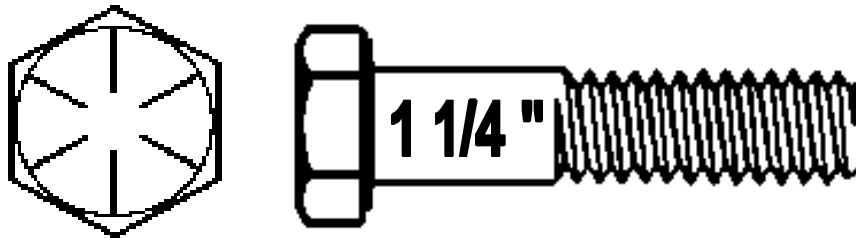

NOTRE CODE NOIR	NOTRE CODE ZINC	DESCRIPTION	QTÉ/BOÎTE	QTÉ/VRAC
OUR CODE BARE	OUR CODE PLATED	DESCRIPTION	QTY/BOX	QTY/BULK
*****	BC692020	1 1/4-7 X 2	-	30
BC392025	*****	1 1/4-7 X 2 1/2	-	25
BC392030	BC692030	1 1/4-7 X 3	-	25
BC392035	BC692035	1 1/4-7 X 3 1/2	-	20
BC392040	BC692040	1 1/4-7 X 4	-	20
BC392055	BC692055	1 1/4-7 X 5 1/2	-	15
BC392060	BC692060	1 1/4-7 X 6	-	15
BC392070	BC592070	1 1/4-7 X 7	-	12
BC392075	BC592075	1 1/4-7 X 7 1/2	-	12
BC392080	BC592080	1 1/4-7 X 8	-	10

BOULONS À TÊTE
 HEXAGONALE
 GRADE 8
 GROS FILETS

NOIR / BARE
 ZINC / PLATED

HEX HEAD
 CAP SCREWS
 GRADE 8
 NATIONAL COARSE

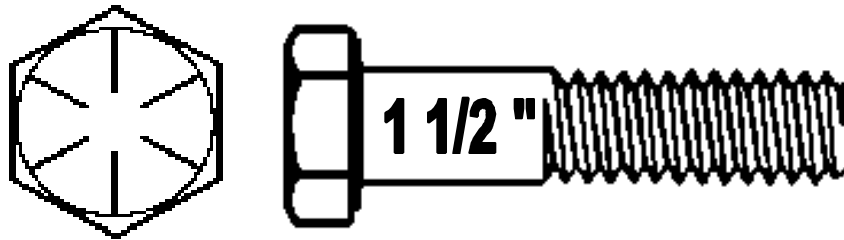

NOTRE CODE NOIR	NOTRE CODE ZINC	DESCRIPTION	QTÉ/BOÎTE	QTÉ/VRAC
OUR CODE BARE	OUR CODE PLATED	DESCRIPTION	QTY/BOX	QTY/BULK
BC395030	BC695030	1 1/2-6 X 3	-	15
BC395035	BC695035	1 1/2-6 X 3 1/2	-	15
BC395040	BC695040	1 1/2-6 X 4	-	12
BC395045	BC695045	1 1/2-6 X 4 1/2	-	12
BC395050	BC695050	1 1/2-6 X 5	-	11
*****	BC695055	1 1/2-6 X 5 1/2	-	10
BC395060	BC695060	1 1/2-6 X 6	-	10
BC395070	*****	1 1/2-6 X 7	-	9
BC395080	*****	1 1/2-6 X 8	-	8

AUTRES DIMENSIONS DISPONIBLES / OTHER DIMENSIONS ARE AVAILABLE



Tel.: (819) 346-2903 / (888) 345-2903 Fax.: (819) 346-3389

Email: distributeur@boulonsestrie.com

BOULONS À TÊTE
 HEXAGONALE
 GRADE 5
 FILETS FINS

NOIR / BARE
 ZINC / PLATED

HEX HEAD
 CAP SCREWS
 GRADE 5
 NATIONAL FINE

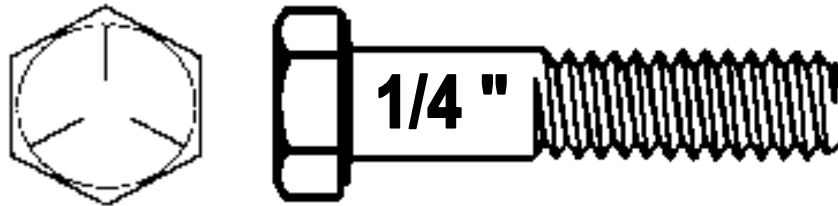

NOTRE CODE NOIR	NOTRE CODE ZINC	DESCRIPTION	QTÉ/BOÎTE	QTÉ/VRAC
OUR CODE BARE	OUR CODE PLATED	DESCRIPTION	QTY/BOX	QTY/BULK
BF225005	BF525005	1/4-28 X 1/2	100	3300
BF225006	BF525006	1/4-28 X 5/8	100	3000
BF225007	BF525007	1/4-28 X 3/4	100	2700
BF225008	*****	1/4-28 X 7/8	100	2500
BF225010	BF525010	1/4-28 X 1	100	2200
BF225012	BF525012	1/4-28 X 1 1/4	100	2000
BF225015	BF525015	1/4-28 X 1 1/2	100	1900
BF225017	BF525017	1/4-28 X 1 3/4	100	1400
BF225020	BF525020	1/4-28 X 2	100	1200
BF225022	BF525022	1/4-28 X 2 1/4	100	1000
BF225025	BF525025	1/4-28 X 2 1/2	100	900
BF225027	*****	1/4-28 X 2 3/4	100	750
BF225030	BF525030	1/4-28 X 3	100	750
BF225032	*****	1/4-28 X 3 1/4	100	600
BF225035	BF525035	1/4-28 X 3 1/2	100	550
BF225037	*****	1/4-28 X 3 3/4	100	500
BF225045	BF525045	1/4-28 X 4 1/2	100	450
*****	BF225050	1/4-28 X 5	100	400
BF225055	*****	1/4-28 X 5 1/2	100	400
BF225060	*****	1/4-28 X 6	100	350

AUTRES DIMENSIONS DISPONIBLES/OTHER DIMENSIONS ARE AVAILABLE



Tel.: (819) 346-2903 / (888) 345-2903 Fax.: (819) 346-3389

Email: distributeur@boulonsestrie.com

BOULONS À TÊTE
HEXAGONALE
GRADE 5
FILETS FINS

NOIR / BARE
ZINC / PLATED

HEX HEAD
CAP SCREWS
GRADE 5
NATIONAL FINE

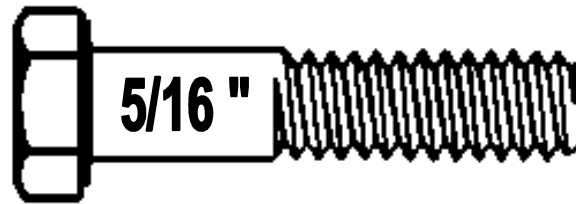

NOTRE CODE NOIR	NOTRE CODE ZINC	DESCRIPTION	QTÉ/BOÎTE	QTÉ/VRAC
OUR CODE BARE	OUR CODE PLATED	DESCRIPTION	QTY/BOX	QTY/BULK
BF231005	*****	5/16-24 X 1/2	100	1950
BF231006	*****	5/16-24 X 5/8	100	1800
BF231007	BF531007	5/16-24 X 3/4	100	1650
BF231008	*****	5/16-24 X 7/8	100	1500
BF231010	BF531010	5/16-24 X 1	100	1400
BF231012	BF531012	5/16-24 X 1 1/4	100	1100
BF231015	BF531015	5/16-24X 1 1/2	100	1000
BF231017	BF531017	5/16-24 X 1 3/4	100	850
BF231020	BF531020	5/16-24 X 2	100	800
BF231022	BF531022	5/16-24 X 2 1/4	100	700
BF231025	BF531025	5/16-24 X 2 1/2	100	600
BF231027	BF531027	5/16-24 X 2 3/4	100	550
BF231030	BF531030	5/16-24 X 3	100	500
BF231032	BF531032	5/16-24 X 3 1/4	100	450
BF231035	*****	5/16-24 X 3 1/2	100	450
*****	*****	5/16-24 X 3 3/4	-	400
BF231040	BF531040	5/16-24 X 4	100	400
BF231045	BF531045	5/16-24 X 4 1/2	100	300
BF231050	*****	5/16-24 X 5	100	250
BF231055	*****	5/16-24 X 5 1/2	100	250
BF231060	*****	5/16-24 X 6	100	250
*****	*****	5/16-24 X 8	100	225

AUTRES DIMENSIONS DISPONIBLES/OTHER DIMENSIONS ARE AVAILABLE



Tel.: (819) 346-2903 / (888) 345-2903 Fax.: (819) 346-3389

Email: distributeur@boulonsestrie.com

BOULONS À TÊTE
HEXAGONALE
GRADE 5
FILETS FINS

NOIR / BARE
ZINC / PLATED

HEX HEAD
CAP SCREWS
GRADE 5
NATIONAL FINE

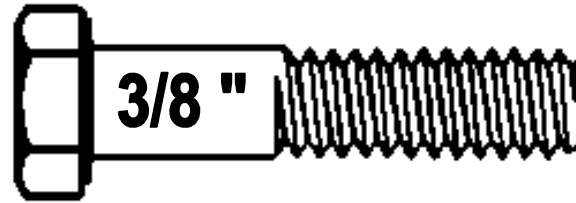

NOTRE CODE NOIR	NOTRE CODE ZINC	DESCRIPTION	QTÉ/BOÎTE	QTÉ/VRAC
OUR CODE BARE	OUR CODE PLATED	DESCRIPTION	QTY/BOX	QTY/BULK
BF237005	BF537005	3/8-24 X 1/2	100	1300
BF237006	*****	3/8-24 X 5/8	100	1200
BF237007	BF537007	3/8-24 X 3/4	100	1100
BF237008	*****	3/8-24 X 7/8	100	1000
BF237010	BF537010	3/8-24 X 1	100	900
BF237012	BF537012	3/8-24 X 1 1/4	100	800
BF237015	BF537015	3/8-24 X 1 1/2	100	675
BF237017	BF537017	3/8-24 X 1 3/4	100	600
BF237020	BF537020	3/8-24 X 2	100	550
BF237022	BF537022	3/8-24 X 2 1/4	100	450
BF237025	BF537025	3/8-24 X 2 1/2	100	400
BF237027	*****	3/8-24 X 2 3/4	100	400
BF237030	BF537030	3/8-24 X 3	100	325
BF237032	*****	3/8-24 X 3 1/4	100	325
BF237035	BF537035	3/8-24 X 3 1/2	100	300
BF237037	*****	3/8-24 X 3 3/4	100	250
BF237040	BF537040	3/8-24 X 4	100	250
BF237045	BF537045	3/8-24 X 4 1/2	100	225
BF237050	BF537050	3/8-24 X 5	100	225
BF237055	BF537055	3/8-24 X 5 1/2	100	175
BF237057	*****	3/8-24 X 5 3/4	100	175
BF237060	BF537060	3/8-24 X 6	100	175
BF237065	*****	3/8-24 X 6 1/2	100	175
BF237070	*****	3/8-24 X 7	100	150

AUTRES DIMENSIONS DISPONIBLES/OTHER DIMENSIONS ARE AVAILABLE



Tel.: (819) 346-2903 / (888) 345-2903 Fax.: (819) 346-3389

Email: distributeur@boulonsestrie.com

BOULONS À TÊTE
 HEXAGONALE
 GRADE 5
 FILETS FINS

NOIR / BARE
 ZINC / PLATED

HEX HEAD
 CAP SCREWS
 GRADE 5
 NATIONAL FINE

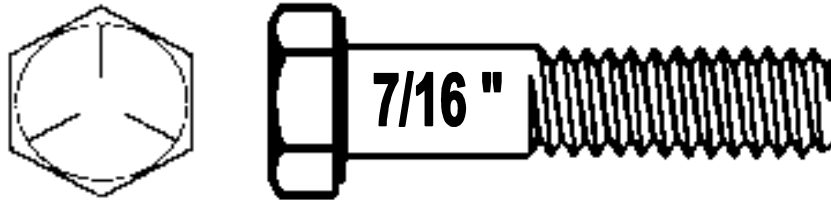

NOTRE CODE NOIR	NOTRE CODE ZINC	DESCRIPTION	QTÉ/BOÎTE	QTÉ/VRAC
OUR CODE BARE	OUR CODE PLATED	DESCRIPTION	QTY/BOX	QTY/BULK
*****	BF543005	7/16-20 X 1/2	50	-
BF243007	BF543007	7/16-20 X 3/4	50	750
BF243010	BF543010	7/16-20 X 1	50	650
BF243012	BF543012	7/16-20 X 1 1/4	50	550
BF243015	BF543015	7/16-20 X 1 1/2	50	500
BF243017	BF543017	7/16-20 X 1 3/4	50	450
BF243020	BF543020	7/16-20 X 2	50	400
BF243022	BF543022	7/16-20 X 2 1/4	50	350
BF243025	BF543025	7/16-20 X 2 1/2	50	300
BF243027	*****	7/16-20 X 2 3/4	50	300
BF243030	BF543030	7/16-20 X 3	50	275
BF243032	BF543032	7/16-20 X 3 1/4	50	250
BF243035	BF543035	7/16-20 X 3 1/2	50	225
BF243037	*****	7/16-20 X 3 3/4	50	225
BF243040	BF543040	7/16-20 X 4	50	200
*****	BF543042	7/16-20 X 4 1/4	50	-
BF243045	BF543045	7/16-20 X 4 1/2	50	175
BF243050	BF543050	7/16-20 X 5	50	150
BF243055	BF543055	7/16-20 X 5 1/2	50	150
BF243060	*****	7/16-20 X 6	50	125

AUTRES DIMENSIONS DISPONIBLES/OTHER DIMENSIONS ARE AVAILABLE



Tel.: (819) 346-2903 / (888) 345-2903 Fax.: (819) 346-3389

Email: distributeur@boulonsestrie.com

BOULONS À TÊTE
 HEXAGONALE
 GRADE 5
 FILETS FINS

NOIR / BARE
 ZINC / PLATED

HEX HEAD
 CAP SCREWS
 GRADE 5
 NATIONAL FINE

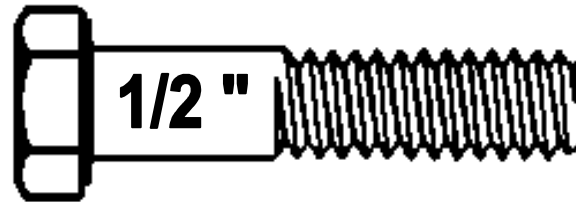

NOTRE CODE NOIR	NOTRE CODE ZINC	DESCRIPTION	QTÉ/BOÎTE	QTÉ/VRAC
OUR CODE BARE	OUR CODE PLATED	DESCRIPTION	QTY/BOX	QTY/BULK
BF250007	BF550007	1/2-20 X 3/4	50	475
BF250008	*****	1/2-20 X 7/8	50	450
BF250010	BF550010	1/2-20 X 1	50	400
BF250012	BF550012	1/2-20 X 1 1/4	50	375
BF250015	BF550015	1/2-20 X 1 1/2	50	300
BF250017	BF550017	1/2-20 X 1 3/4	50	275
BF250020	BF550020	1/2-20 X 2	50	250
BF250022	BF550022	1/2-20 X 2 1/4	50	225
BF250025	BF550025	1/2-20 X 2 1/2	50	225
BF250027	*****	1/2-20 X 2 3/4	50	200
BF250030	BF550030	1/2-20 X 3	50	200
BF250032	BF550032	1/2-20 X 3 1/4	50	175
BF250035	BF550035	1/2-20 X 3 1/2	50	150
BF250037	BF550037	1/2-20 X 3 3/4	50	150
BF250040	BF550040	1/2-20 X 4	50	150
BF250045	BF550045	1/2-20 X 4 1/2	50	125
BF250050	BF550050	1/2-20 X 5	50	125
BF250055	BF550055	1/2-20 X 5 1/2	50	100
BF250060	BF550060	1/2-20 X 6	50	100
BF250065	BF550065	1/2-20 X 6 1/2	50	100
BF250070	BF550070	1/2-20 X 7	50	90
*****	*****	1/2-20 X 7 1/2	-	-
BC250080	BF550080	1/2-20 X 8	-	-

AUTRES DIMENSIONS DISPONIBLES/OTHER DIMENSIONS ARE AVAILABLE



Tel.: (819) 346-2903 / (888) 345-2903 Fax.: (819) 346-3389

Email: distributeur@boulonsestrie.com

A-41

BOULONS À TÊTE
HEXAGONALE
GRADE 5
FILETS FINS

NOIR / BARE
ZINC / PLATED

HEX HEAD
CAP SCREWS
GRADE 5
NATIONAL FINE

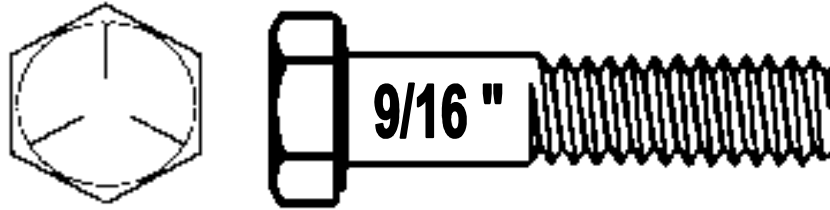

NOTRE CODE NOIR	NOTRE CODE ZINC	DESCRIPTION	QTÉ/BOÎTE	QTÉ/VRAC
OUR CODE BARE	OUR CODE PLATED	DESCRIPTION	QTY/BOX	QTY/BULK
BF256010	*****	9/16-18 X 1	25	350
BF256012	*****	9/16-18 X 1 1/4	25	300
BF256015	BF556015	9/16-18 X 1 1/2	25	275
BF256017	BF556017	9/16-18 X 1 3/4	25	250
BF256020	*****	9/16-18 X 2	25	225
BF256022	BF556022	9/16-18 X 2 1/4	25	200
BF256025	*****	9/16-18 X 2 1/2	25	175
BF256027	*****	9/16-18 X 2 3/4	25	150
BF256030	BF556030	9/16-18 X 3	25	150
BF256035	BF556035	9/16-18 X 3 1/2	25	125
BF256040	BF556040	9/16-18 X 4	25	100
BF256045	*****	9/16-18 X 4 1/2	25	100
BF256050	BF556050	9/16-18 X 5	25	100
BF256055	*****	9/16-18 X 5 1/2	25	75
BF256060	*****	9/16-18 X 6	25	75

AUTRES DIMENSIONS DISPONIBLES/OTHER DIMENSIONS ARE AVAILABLE



Tel.: (819) 346-2903 / (888) 345-2903 Fax.: (819) 346-3389

Email: distributeur@boulonsestrie.com

BOULONS À TÊTE
 HEXAGONALE
 GRADE 5
 FILETS FINS

NOIR / BARE
 ZINC / PLATED

HEX HEAD
 CAP SCREWS
 GRADE 5
 NATIONAL FINE



NOTRE CODE NOIR	NOTRE CODE ZINC	DESCRIPTION	QTÉ/BOÎTE	QTÉ/VRAC
OUR CODE BARE	OUR CODE PLATED	DESCRIPTION	QTY/BOX	QTY/BULK
BF262010	BF562010	5/8-18 X 1	25	250
BF262012	BF562012	5/8-18 X 1 1/4	25	225
BF262015	BF562015	5/8-18 X 1 1/2	25	200
BF262017	BF562017	5/8-18 X 1 3/4	25	175
BF262020	BF562020	5/8-18 X 2	25	175
BF262022	BF562022	5/8-18 X 2 1/4	25	175
BF262025	BF562025	5/8-18 X 2 1/2	25	125
BF262027	BF562027	5/8-18 X 2 3/4	25	125
BF262030	BF562030	5/8-18 X 3	25	100
BF262032	*****	5/8-18 X 3 1/4	25	100
BF262035	BF562035	5/8-18 X 3 1/2	25	100
BF262037	BF562037	5/8-18 X 3 3/4	25	100
BF262040	BF562040	5/8-18 X 4	25	90
BF262045	BF562045	5/8-18 X 4 1/2	25	80
BF262050	BF562050	5/8-18 X 5	25	75
BF262055	BF562055	5/8-18 X 5 1/2	25	70
BF262060	BC562060	5/8-18 X 6	25	65
BF262065	*****	5/8-18 X 6 1/2	25	60
BF262070	BF562070	5/8-18 X 7	25	55
BF262080	BF562080	5/8-18 X 8	25	50
BF262100	*****	5/8-18 X 10	-	40
BF262110	*****	5/8-18 X 11	-	40

AUTRES DIMENSIONS DISPONIBLES/OTHER DIMENSIONS ARE AVAILABLE



Tel.: (819) 346-2903 / (888) 345-2903 Fax.: (819) 346-3389

Email: distributeur@boulonsestrie.com

BOULONS À TÊTE
HEXAGONALE
GRADE 5
FILETS FINS

NOIR / BARE
ZINC / PLATED

HEX HEAD
CAP SCREWS
GRADE 5
NATIONAL FINE

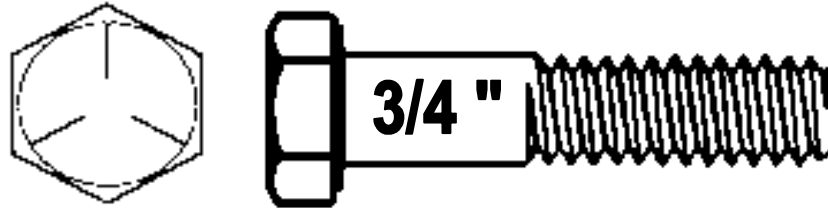

NOTRE CODE NOIR	NOTRE CODE ZINC	DESCRIPTION	QTÉ/BOÎTE	QTÉ/VRAC
OUR CODE BARE	OUR CODE PLATED	DESCRIPTION	QTY/BOX	QTY/BULK
BF275010	*****	3/4-16 X 1	20	150
BF275012	*****	3/4-16 X 1 1/4	20	140
BF275015	BF575015	3/4-16 X 1 1/2	20	125
BF275017	BF575017	3/4-16 X 1 3/4	20	120
BF275020	BF575020	3/4-16 X 2	20	100
BF275022	BF575022	3/4-16 X 2 1/4	20	100
BF275025	BF575025	3/4-16 X 2 1/2	20	90
BF275027	BF575027	3/4-16 X 2 3/4	20	85
BF275030	BF575030	3/4-16 X 3	20	80
BF275032	BF575032	3/4-16 X 3 1/4	20	75
BF275035	BF575035	3/4-16 X 3 1/2	20	70
BF275040	BF575040	3/4-16 X 4	20	60
BF275045	BF575045	3/4-16 X 4 1/2	20	55
BF275050	BF575050	3/4-16 X 5	20	45
BF275055	BF575055	3/4-16 X 5 1/2	20	45
BF275057	*****	3/4-16 X 5 3/4	20	-
BF275060	BF575060	3/4-16 X 6	20	40
BF275062	*****	3/4-16 X 6 1/4	20	-
BF275065	BF575065	3/4-16 X 6 1/2	20	40
BF275070	BF575070	3/4-16 X 7	20	35
BF275080	*****	3/4-16 X 8	15	35
BF275090	*****	3/4-16 X 9	-	30
BF275095	*****	3/4-16 X 9 1/2	-	30
BF275100	*****	3/4-16 X 10	-	30

AUTRES DIMENSIONS DISPONIBLES/OTHER DIMENSIONS ARE AVAILABLE



Tel.: (819) 346-2903 / (888) 345-2903 Fax.: (819) 346-3389

Email: distributeur@boulonsestrie.com

A-44

BOULONS À TÊTE
 HEXAGONALE
 GRADE 5
 FILETS FINS

NOIR / BARE
 ZINC / PLATED

HEX HEAD
 CAP SCREWS
 GRADE 5
 NATIONAL FINE

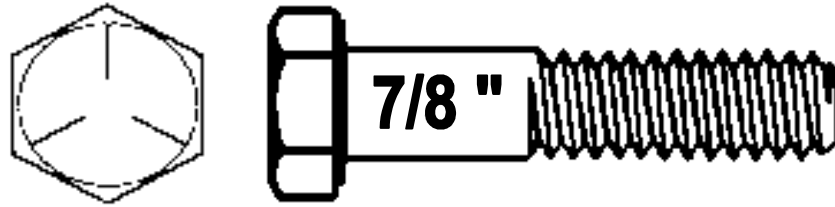

NOTRE CODE NOIR	NOTRE CODE ZINC	DESCRIPTION	QTÉ/BOÎTE	QTÉ/VRAC
OUR CODE BARE	OUR CODE PLATED	DESCRIPTION	QTY/BOX	QTY/BULK
BF287010	*****	7/8-14 X 1	20	-
BF287015	*****	7/8-14 X 1 1/2	20	85
BF287017	BF587017	7/8-14 X 1 3/4	20	80
BF287020	*****	7/8-14 X 2	20	75
*****	BF587022	7/8-14 X 2 1/4	20	70
BF287025	BF587025	7/8-14 X 2 1/2	20	65
BF287027	BF587027	7/8-14 X 2 3/4	20	60
BF287030	BF587030	7/8-14 X 3	20	55
BF287032	*****	7/8-14 X 3 1/4	20	50
BF287035	BF587035	7/8-14 X 3 1/2	20	50
*****	BF587037	7/8-14 X 3 3/4	20	45
BF287040	BF587040	7/8-14 X 4	20	45
BF287045	BF587045	7/8-14 X 4 1/2	20	40
BF287050	BF587050	7/8-14 X 5	20	35
BF287055	*****	7/8-14 X 5 1/2	10	35
BF287060	*****	7/8-14 X 6	10	30
BF287065	*****	7/8-14 X 6 1/2	10	30
BF287070	*****	7/8-14 X 7	10	25
BF287080	*****	7/8-14 X 8	10	25
BF287090	*****	7/8-14 X 9	-	23
*****	*****	7/8-14 X 10	-	20

AUTRES DIMENSIONS DISPONIBLES/OTHER DIMENSIONS ARE AVAILABLE



Tel.: (819) 346-2903 / (888) 345-2903 Fax.: (819) 346-3389

Email: distributeur@boulonsestrie.com

BOULONS À TÊTE
 HEXAGONALE
 GRADE 5
 FILETS FINS

NOIR / BARE
 ZINC / PLATED

HEX HEAD
 CAP SCREWS
 GRADE 5
 NATIONAL FINE

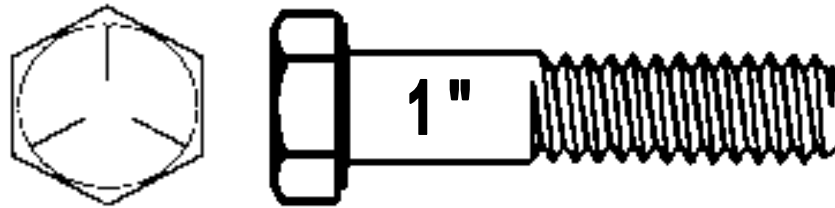

NOTRE CODE NOIR	NOTRE CODE ZINC	DESCRIPTION	QTÉ/BOÎTE	QTÉ/VRAC
OUR CODE BARE	OUR CODE PLATED	DESCRIPTION	QTY/BOX	QTY/BULK
BF290015	*****	1-14 X 1 1/2	20	55
BF290017	*****	1-14 X 1 3/4	20	55
BF290020	BF590020	1-14 X 2	10	50
BF290022	*****	1-14 X 2 1/4	20	50
BF290025	*****	1-14 X 2 1/2	20	45
*****	*****	1-14 X 2 3/4	20	40
BF290030	*****	1-14 X 3	20	40
BF290035	*****	1-14 X 3 1/2	10	35
BF290040	*****	1-14 X 4	10	35
BF290045	*****	1-14 X 4 1/2	10	30
BF290050	BF590050	1-14 X 5	10	25
BF290055	*****	1-14 X 5 1/2	10	25
BF290060	*****	1-14 X 6	10	25
BF290065	*****	1-14 X 6 1/2	10	20
BF290070	*****	1-14 X 7	10	20
BF290075	*****	1-14 X 7 1/2	10	20
BF290080	BF590080	1-14 X 8	10	18

AUTRES DIMENSIONS DISPONIBLES/OTHER DIMENSIONS ARE AVAILABLE



Tel.: (819) 346-2903 / (888) 345-2903 Fax.: (819) 346-3389

Email: distributeur@boulonsestrie.com

**BOULONS À TÊTE
HEXAGONALE
GRADE 5
FILETS FINS**

**NOIR / BARE
ZINC / PLATED**

**HEX HEAD
CAP SCREWS
GRADE 5
NATIONAL FINE**

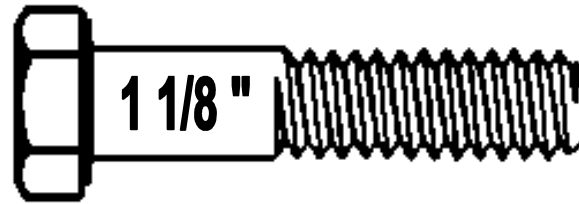

NOTRE CODE NOIR	NOTRE CODE ZINC	DESCRIPTION	QTÉ/BOÎTE	QTÉ/VRAC
OUR CODE BARE	OUR CODE PLATED	DESCRIPTION	QTY/BOX	QTY/BULK
*****	*****	1 1/8-7 X 2	VRAC/BULK	15
*****	*****	1 1/8-7 X 2 1/2	VRAC/BULK	35
*****	*****	1 1/8-7 X 3 1/2	VRAC/BULK	30
*****	*****	1 1/8-7 X 4	10	25
*****	*****	1 1/8-7 X 4 1/2	10	20
*****	*****	1 1/8-7 X 5	10	20
*****	*****	1 1/8-7 X 5 1/2	10	20

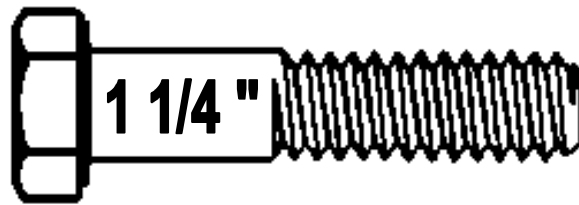
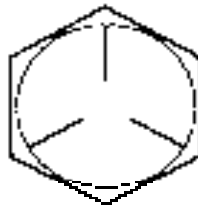

NOTRE CODE NOIR	NOTRE CODE ZINC	DESCRIPTION	QTÉ/BOÎTE	QTÉ/VRAC
OUR CODE BARE	OUR CODE PLATED	DESCRIPTION	QTY/BOX	QTY/BULK
*****	*****	1 1/4-7 X 2	10	30
*****	BC592030	1 1/4-7 X 3	10	25
BF292040	BC592040	1 1/4-7 X 4	10	20
BF292045	BC592045	1 1/4-7 X 4 1/2	10	
BF292050	BC592050	1 1/4-7 X 5		
BF292055	BC592055	1 1/4-7 X 5 1/2	10	15
BF292060	BC59200	1 1/4-7 X 6	10	15
*****	BC592065	1 1/4-7 X 6 1/2		
BF292080	*****	1 1/4-7 X 8	VRAC/BULK	10
*****	BC592090	1 1/4-7 X 9		

AUTRES DIMENSIONS DISPONIBLES/OTHER DIMENSIONS ARE AVAILABLE

**BOULONS À TÊTE
HEXAGONALE
GRADE 5
FILETS FINS**

**NOIR / BARE
ZINC / PLATED**

**HEX HEAD
CAP SCREWS
GRADE 5
NATIONAL FINE**

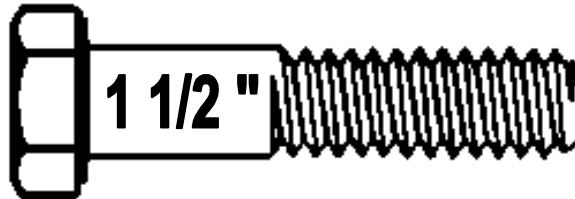

NOTRE CODE NOIR	NOTRE CODE ZINC	DESCRIPTION	QTÉ/BOÎTE	QTÉ/VRAC
OUR CODE BARE	OUR CODE PLATED	DESCRIPTION	QTY/BOX	QTY/BULK
BC295030	BC595030	1 1/2-6 X 3	-	15
BC295035	*****	1 1/2-6 X 3 1/2	-	15
BC292040	BC595040	1 1/2-6 X 4	-	12
*****	*****	1 1/2-6 X 4 1/2	-	12
BC295050	BC595050	1/2-6 X 5	-	11
BC295055	*****	1 1/2-6 X 5 1/2	-	10
BC295060	BC595060	1 1/2-6 X 6	-	10
BC295065	BC595065	1 1/2-6 X 6 1/2	-	9
*****	BC595070	1 1/2-6 X 7	-	9
*****	BC595080	1 1/2-6 X 8	-	8
BC295100	*****	1 1/2-6 X 10	-	6

AUTRES DIMENSIONS DISPONIBLES/OTHER DIMENSIONS ARE AVAILABLE



Tel.: (819) 346-2903 / (888) 345-2903 Fax.: (819) 346-3389

Email: distributeur@boulonsestrie.com

BOULONS À TÊTE
 HEXAGONALE
 GRADE 8
 FILETS FINS

NOIR / BARE
 ZINC / PLATED

HEX HEAD
 CAP SCREWS
 GRADE 8
 NATIONAL FINE

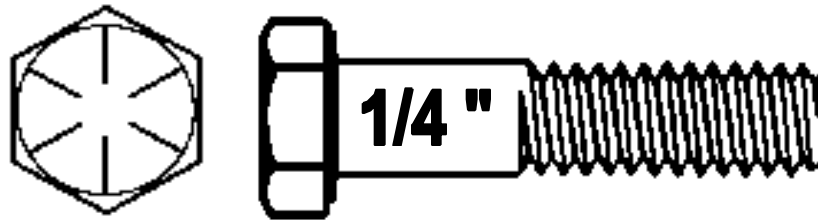

NOTRE CODE NOIR	NOTRE CODE ZINC	DESCRIPTION	QTÉ/BOÎTE	QTÉ/VRAC
OUR CODE BARE	OUR CODE PLATED	DESCRIPTION	QTY/BOX	QTY/BULK
BF325005	BF625005	1/4-28 X 1/2	100	3300
BF325006	BF625006	1/4-28 X 5/8	100	-
BF325007	BF625007	1/4-28 X 3/4	100	2700
BF325010	BF625010	1/4-28 X 1	100	2200
BF325012	BF625012	1/4-28 X 1 1/4	100	1900
BF325015	BF625015	1/4-28 X 1 1/2	100	1900
BF325017	*****	1/4-28 X 1 3/4	100	1400
BF325020	BF625020	1/4-28 X 2	100	1200
BF325022	*****	1/4-28 X 2 1/4	100	1000
BF325025	*****	1/4-28 X 2 1/2	100	900
*****	BF625027	1/4-28 X 2 3/4	100	750
BF325030	*****	1/4-28 X 3	100	750
BF325035	*****	1/4-28 X 3 1/2	100	550
BF325040	*****	1/4-28 X 4	100	450
BF325050	*****	1/4-28 X 5	100	400
BF325055	*****	1/4-28 X 5 1/2	100	400
BF325060	*****	1/4-28 X 6	100	350

AUTRES DIMENSIONS DISPONIBLES/OTHER DIMENSIONS ARE AVAILABLE



Tel.: (819) 346-2903 / (888) 345-2903 Fax.: (819) 346-3389
 Email: distributeur@boulonsestrie.com

BOULONS À TÊTE
 HEXAGONALE
 GRADE 8
 FILETS FINS

NOIR / BARE
 ZINC / PLATED

HEX HEAD
 CAP SCREWS
 GRADE 8
 NATIONAL FINE

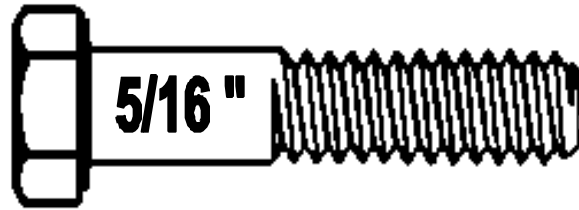

NOTRE CODE NOIR	NOTRE CODE ZINC	DESCRIPTION	QTÉ/BOÎTE	QTÉ/VRAC
OUR CODE BARE	OUR CODE PLATED	DESCRIPTION	QTY/BOX	QTY/BULK
BF331005	*****	5/16-24 X 1/2	100	1950
BF331007	BF631007	5/16-24 X 3/4	100	1650
*****	BF631008	5/16-24 X 7/8	-	1500
BF331010	BF631010	5/16-24 X 1	100	1400
BF331012	*****	5/16-24 X 1 1/4	100	1100
BF331015	BF631015	5/16-24 X 1 1/2	100	1000
BF331017	*****	5/16-24 X 1 3/4	100	850
BF331020	*****	5/16-24 X 2	100	800
BF331022	*****	5/16-24 X 2 1/4	100	700
BF331025	*****	5/16-24 X 2 1/2	100	600
*****	*****	5/16-24 X 2 3/4	100	550
BF331030	BF631030	5/16-24 X 3	100	500
*****	*****	5/16-24 X 3 1/4	100	450
BF331035	*****	5/16-24 X 3 1/2	100	450
BF331040	*****	5/16-24 X 4	100	400
BF331045	*****	5/16-24 X 4 1/2	100	300
BF331050	*****	5/16-24 X 5	100	250
BF331055	BF631055	5/16-24 X 5 1/2	100	250
BF331060	*****	5/16-24 X 6	100	250
BF331065	*****	5/16-24 X 6 1/2	100	250

AUTRES DIMENSIONS DISPONIBLES/OTHER DIMENSIONS ARE AVAILABLE



Tel.: (819) 346-2903 / (888) 345-2903 Fax.: (819) 346-3389

Email: distributeur@boulonsestrie.com

A-50

BOULONS À TÊTE
 HEXAGONALE
 GRADE 8
 FILETS FINS

NOIR / BARE
 ZINC / PLATED

HEX HEAD
 CAP SCREWS
 GRADE 8
 NATIONAL FINE

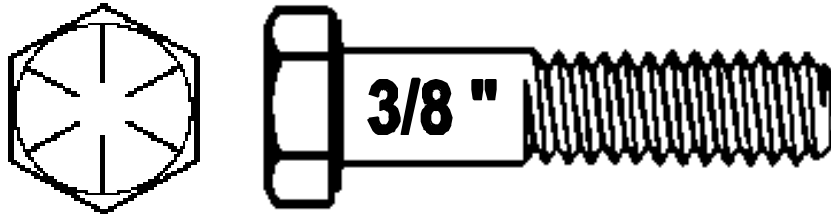

NOTRE CODE NOIR	NOTRE CODE ZINC	DESCRIPTION	QTÉ/BOÎTE	QTÉ/VRAC
OUR CODE BARE	OUR CODE PLATED	DESCRIPTION	QTY/BOX	QTY/BULK
BF337005	*****	3/8-24 X 1/2	100	1300
BF337007	BF637007	3/8-24 X 3/4	100	1100
*****	BF637008	3/8-24 X 7/8	100	1000
BF337010	*****	3/8-24 X 1	100	900
BF337012	BF637012	3/8-24 X 1 1/4	100	800
BF337015	*****	3/8-24 X 1 1/2	100	675
BF337017	*****	3/8-24 X 1 3/4	100	600
BF337020	*****	3/8-24 X 2	100	550
BF337022	*****	3/8-24 X 2 1/4	100	450
BF337025	BF637025	3/8-24 X 2 1/2	100	400
BF337027	BF637027	3/8-24 X 2 3/4	100	400
BF337030	*****	3/8-24 X 3	100	325
BF337032	*****	3/8-24 X 3 1/4	100	325
BF337035	BF637035	3/8-24 X 3 1/2	100	300
BF337040	*****	3/8-24 X 4	100	250
BF337045	*****	3/8-24 X 4 1/2	100	225
BF337050	*****	3/8-24 X 5	50	225
BF337055	*****	3/8-24 X 5 1/2	50	175
BF337060	*****	3/8-24 X 6	50	175

AUTRES DIMENSIONS DISPONIBLES/OTHER DIMENSIONS ARE AVAILABLE



Tel.: (819) 346-2903 / (888) 345-2903 Fax.: (819) 346-3389

Email: distributeur@boulonsestrie.com

**BOULONS À TÊTE
HEXAGONALE
GRADE 8
FILETS FINS**

**NOIR / BARE
ZINC / PLATED**

**HEX HEAD
CAP SCREWS
GRADE 8
NATIONAL FINE**

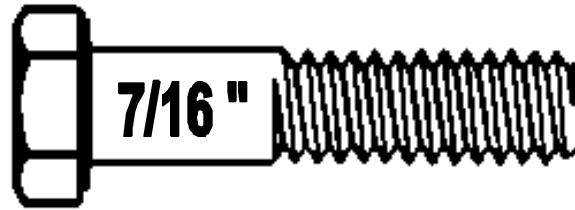
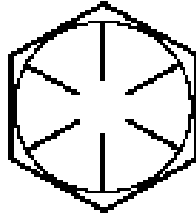

NOTRE CODE NOIR	NOTRE CODE ZINC	DESCRIPTION	QTÉ/BOÎTE	QTÉ/VRAC
OUR CODE BARE	OUR CODE PLATED	DESCRIPTION	QTY/BOX	QTY/BULK
BF343010	BF643010	7/16-20 X 1	50	650
BF343012	BF643012	7/16-20 X 1 1/4	50	550
BF343015	BF643015	7/16-20 X 1 1/2	50	500
BF343017	BF643017	7/16-20 X 1 3/4	50	450
BF343020	BF643020	7/16-20 X 2	50	400
BF343022	*****	7/16-20 X 2 1/4	50	350
BF343025	*****	7/16-20 X 2 1/2	50	300
BF343030	*****	7/16-20 X 3	50	275
BF343032	BF643032	7/16-20- X 3 1/4	-	250
BF343040	BF643040	7/16-20 X 4	50	200
BF343045	*****	7/16-20 X 4 1/2	50	175
BF343050	*****	7/16-20 X 5	50	150
BF343060	*****	7/16-20 X 6	50	125

AUTRES DIMENSIONS DISPONIBLES/OTHER DIMENSIONS ARE AVAILABLE



**Tel.: (819) 346-2903 / (888) 345-2903 Fax.: (819) 346-3389
Email: distributeur@boulonsestrie.com**

BOULONS À TÊTE
HEXAGONALE
GRADE 8
FILETS FINS

NOIR / BARE
ZINC / PLATED

HEX HEAD
CAP SCREWS
GRADE 8
NATIONAL FINE

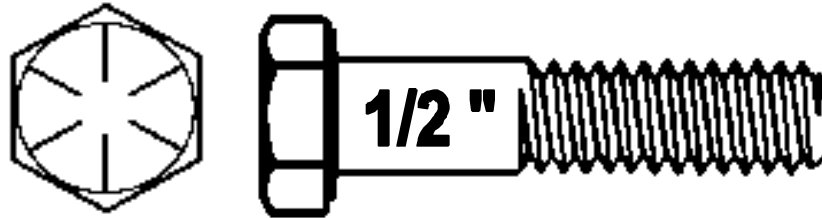

NOTRE CODE NOIR	NOTRE CODE ZINC	DESCRIPTION	QTÉ/BOÎTE	QTÉ/VRAC
OUR CODE BARE	OUR CODE PLATED	DESCRIPTION	QTY/BOX	QTY/BULK
BF350007	*****	1/2-20 X 3/4	-	475
BF350010	BF650010	1/2-20 X 1	50	400
BF350012	*****	1/2-20 X 1 1/4	50	375
BF350015	BF650015	1/2-20 X 1 1/2	50	300
BF350017	BF650017	1/2-20 X 1 3/4	50	275
BF350020	BF650020	1/2-20 X 2	50	250
BF350022	*****	1/2-20 X 2 1/4	50	225
BF350025	BF650025	1/2-20 X 2 1/2	50	225
BF350027	*****	1/2-20 X 2 3/4	50	200
BF350030	BF650030	1/2-20 X 3	50	200
BF350032	*****	1/2-20 X 3 1/4	50	175
BF350035	BF650035	1/2-20 X 3 1/2	50	150
BF350037	*****	1/2-20 X 3 3/4	50	150
BF350040	BF650040	1/2-20 X 4	50	150
BF350045	*****	1/2-20 X 4 1/2	50	125
BF350050	*****	1/2-20 X 5	50	125
BF350055	*****	1/2-20 X 5 1/2	25	100
BF350060	*****	1/2-20 X 6	25	100
BF350065	*****	1/2-20 X 6 1/2	25	100
BF350070	*****	1/2-20 X 7	25	90
BF350080	*****	1/2-20 X 8	25	80

AUTRES DIMENSIONS DISPONIBLES/OTHER DIMENSIONS ARE AVAILABLE



Tel.: (819) 346-2903 / (888) 345-2903 Fax.: (819) 346-3389

Email: distributeur@boulonsestrie.com

BOULONS À TÊTE
 HEXAGONALE
 GRADE 8
 FILETS FINS

NOIR / BARE
 ZINC / PLATED

HEX HEAD
 CAP SCREWS
 GRADE 8
 NATIONAL FINE

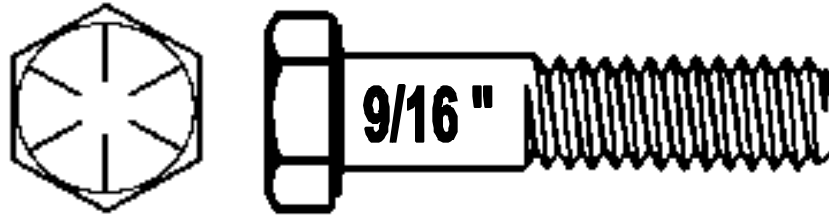

NOTRE CODE NOIR	NOTRE CODE ZINC	DESCRIPTION	QTÉ/BOÎTE	QTÉ/VRAC
OUR CODE BARE	OUR CODE PLATED	DESCRIPTION	QTY/BOX	QTY/BULK
BF356010	*****	9/16-18 X 1	25	350
BF356012	*****	9/16-18 X 1 1/4	25	300
BF356015	*****	9/16-18 X 1 1/2	25	275
BF356017	*****	9/16-18 X 1 3/4	25	250
BF356020	*****	9/16-18 X 2	25	225
BF356022	*****	9/16-18 X 2 1/4	25	200
BF356025	*****	9/16-18 X 2 1/2	25	175
BF356027	*****	9/16-18 X 2 3/4	25	150
BF356030	*****	9/16-18 X 3	25	150
BF356035	*****	9/16-18 X 3 1/2	25	125
BF356040	*****	9/16-18 X 4	25	100
BF356045	*****	9/16-18 X 4 1/2	25	100
BF356050	*****	9/16-18 X 5	25	100
*****	BF656055	9/16-18 X 5 1/2	25	75
BF356060	*****	9/16-18 X 6	25	75

AUTRES DIMENSIONS DISPONIBLES/OTHER DIMENSIONS ARE AVAILABLE



Tel.: (819) 346-2903 / (888) 345-2903 Fax.: (819) 346-3389
 Email: distributeur@boulonstrie.com

BOULONS À TÊTE
 HEXAGONALE
 GRADE 8
 FILETS FINS

NOIR / BARE
 ZINC / PLATED

HEX HEAD
 CAP SCREWS
 GRADE 8
 NATIONAL FINE

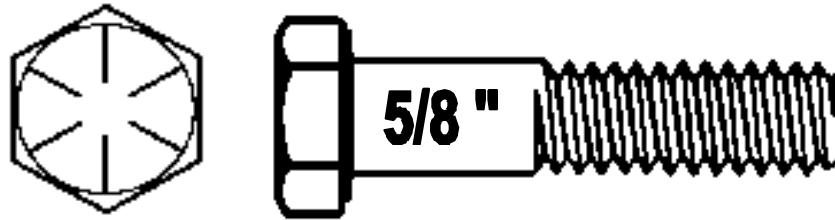

NOTRE CODE NOIR	NOTRE CODE ZINC	DESCRIPTION	QTÉ/BOÎTE	QTÉ/VRAC
OUR CODE BARE	OUR CODE PLATED	DESCRIPTION	QTY/BOX	QTY/BULK
BF362010	BF662010	5/8-18 X 1	25	250
BF362012	BF662012	5/8-18 X 1 1/4	25	225
BF362015	BF662015	5/8-18 X 1 1/2	25	200
BF362017	BF662017	5/8-18 X 1 3/4	25	175
BF362020	BF662020	5/8-18 X 2	25	175
BF362022	BF662022	5/8-18 X 2 1/4	25	175
BF362025	BF662025	5/8-18 X 2 1/2	25	125
BF362027	*****	5/8-18 X 2 3/4	25	125
BF362030	*****	5/8-18 X 3	25	100
BF362032	BF662032	5/8-18 X 3 1/4	25	100
BF362035	BF662035	5/8-18 X 3 1/2	25	100
BF362037	*****	5/8-18 X 3 3/4	25	100
BF362040	*****	5/8-18 X 4	25	90
BF362045	BF662045	5/8-18 X 4 1/2	25	80
BF362050	*****	5/8-18 X 5	25	75
BF362055	*****	5/8-18 X 5 1/2	25	70
BF362060	*****	5/8-18 X 6	25	65
BF362065	*****	5/8-18 X 6 1/2	25	60
BF362075	*****	5/8-18 X 7 1/2	25	55
BF362080	*****	5/8-18 X 8	25	50
BF362085	*****	5/8-18 X 8 1/2	25	50
BF362100	*****	5/8-18 X 10	-	40

AUTRES DIMENSIONS DISPONIBLES/OTHER DIMENSIONS ARE AVAILABLE



Tel.: (819) 346-2903 / (888) 345-2903 Fax.: (819) 346-3389

Email: distributeur@boulonsestrie.com

BOULONS À TÊTE
 HEXAGONALE
 GRADE 8
 FILETS FINS

NOIR / BARE
 ZINC / PLATED

HEX HEAD
 CAP SCREWS
 GRADE 8
 NATIONAL FINE

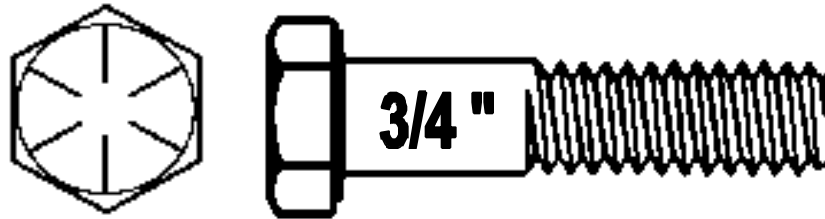

NOTRE CODE NOIR	NOTRE CODE ZINC	DESCRIPTION	QTÉ/BOÎTE	QTÉ/VRAC
OUR CODE BARE	OUR CODE PLATED	DESCRIPTION	QTY/BOX	QTY/BULK
BF375010	BF675010	3/4-16 X 1	20	150
*****	*****	3/4-16 X 1 1/4	20	140
BF375015	BF675015	3/4-16 X 1 1/2	20	125
BF375017	*****	3/4-16 X 1 3/4	20	120
BF375020	BF675020	3/4-16 X 2	20	100
BF375022	BF675022	3/4-16 X 2 1/4	20	100
BF375025	BF675025	3/4-16 X 2 1/2	20	90
BF375027	BF675027	3/4-16 X 2 3/4	20	85
BF375030	BF675030	3/4-16 X 3	20	80
BF375032	*****	3/4-16 X 3 1/4	20	75
*****	BF675035	3/4-16 X 3 1/2	20	70
*****	*****	3/4-16 X 3 3/4	-	65
BF375040	*****	3/4-16 X 4	20	60
BF375045	BF675045	3/4-16 X 4 1/2	20	55
*****	*****	3/4-16 X 4 3/4	20	50
BF375050	*****	3/4-16 X 5	20	45
BF375055	*****	3/4-16 X 5 1/2	20	45
BF375060	BF675060	3/4-16 X 6	20	40
BF375065	*****	3/4-16 X 6 1/2	20	40
BF375070	*****	3/4-16 X 7	20	35
BF375075	*****	3/4-16 X 7 1/2	-	35
BF375080	*****	3/4-16 X 8	15	35
BF375085	*****	3/4-16 X 8 1/2	-	30

AUTRES DIMENSIONS DISPONIBLES/OTHER DIMENSIONS ARE AVAILABLE



Tel.: (819) 346-2903 / (888) 345-2903 Fax.: (819) 346-3389

Email: distributeur@boulonsestrie.com

**BOULONS À TÊTE
HEXAGONALE
GRADE 8
FILETS FINS**

**NOIR / BARE
ZINC / PLATED**

**HEX HEAD
CAP SCREWS
GRADE 8
NATIONAL FINE**

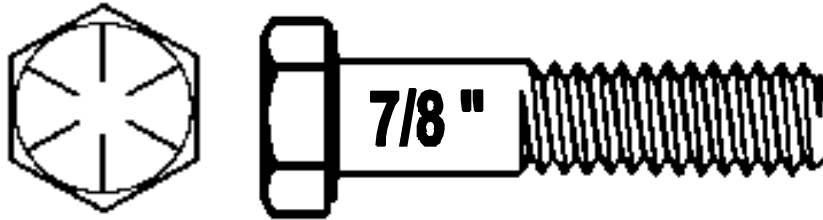

NOTRE CODE NOIR	NOTRE CODE ZINC	DESCRIPTION	QTÉ/BOÎTE	QTÉ/VRAC
OUR CODE BARE	OUR CODE PLATED	DESCRIPTION	QTY/BOX	QTY/BULK
BF387015	*****	7/8-14 X 1 1/2	-	80
BF387017	*****	7/8-14 X 1 3/4	-	80
BF387020	BF687020	7/8-14 X 2	20	75
*****	*****	7/8-14 X 2 1/4	20	70
BF387025	BF687025	7/8-14 X 2 1/2	20	65
*****	BF687027	7/8-14 X 2 3/4	20	60
BF387030	*****	7/8-14 X 3	20	55
BF387035	BF678035	7/8-14 X 3 1/2	20	50
BF387040	*****	7/8-14 X 4	20	45
*****	*****	7/8-14 X 4 1/2	20	40
BF387050	*****	7/8-14 X 5	20	35
BF387055	*****	7/8-14 X 5 1/2	10	35
BF387060	*****	7/8-14 X 6	10	30
BF387065	*****	7/8-14 X 6 1/2	10	30
BF387070	*****	7/8-14 X 7	10	25
BF387075	*****	7/8-14 X 7 1/2	10	25
BF387080	BF687080	7/8-14 X 8	10	25
BF387090	*****	7/8-14 X 9	-	23
BF387100	*****	7/8-14 X 10	-	20

AUTRES DIMENSIONS DISPONIBLES/OTHER DIMENSIONS ARE AVAILABLE



**Tel.: (819) 346-2903 / (888) 345-2903 Fax.: (819) 346-3389
Email: distributeur@boulonsestrie.com**

BOULONS À TÊTE
 HEXAGONALE
 GRADE 8
 FILETS FINS

NOIR / BARE
 ZINC / PLATED

HEX HEAD
 CAP SCREWS
 GRADE 8
 NATIONAL FINE

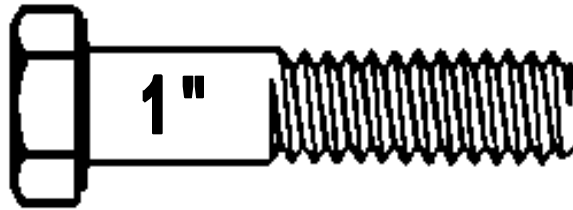
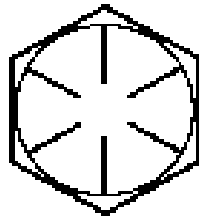

NOTRE CODE NOIR	NOTRE CODE ZINC	DESCRIPTION	QTÉ/BOÎTE	QTÉ/VRAC
OUR CODE BARE	OUR CODE PLATED	DESCRIPTION	QTY/BOX	QTY/BULK
*****	*****	1-14 X 1 1/2	-	55
*****	*****	1-14 X 1 3/4	-	55
*****	*****	1-14 X 2	20	50
BF390022	BF690022	1-14 X 2 1/4	20	50
BF390025	BF690025	1-14 X 2 1/2	20	45
*****	*****	1-14 X 2 3/4	-	40
BF390030	BF690030	1-14 X 3	20	40
BF390035	BF690035	1-14 X 3 1/2	10	35
*****	*****	1-14 X 3 3/4	-	35
BF390040	*****	1-14 X 4	10	35
BF390045	*****	1-14 X 4 1/2	10	30
*****	*****	1-14 X 5	10	25
*****	*****	1-14 X 5 1/2	10	25
BF390060	*****	1-14 X 6	10	25
BF390065	*****	1-14 X 6 1/2	-	20
*****	BF690070	1-14 X 7	10	20
BF390075	BF690075	1-14 X 7 1/2	-	20
*****	*****	1-14 X 8	-	18
*****	*****	1-14 X 8 1/2	-	18
BF390090	BF690090	1-14 X 9	-	15
*****	*****	1-14 X 9 1/2	-	15
BF390100	*****	1-14 X 10	-	15
BF390120	*****	1-14 X 12	-	-
BF390130	*****	1-14 X 13	-	-
*****	*****	1-14 X 15	-	-

AUTRES DIMENSIONS DISPONIBLES/OTHER DIMENSIONS ARE AVAILABLE

BOULONS À TÊTE
HEXAGONALE
GROS FILETS

ZINC / PLATED
L-9

HEX HEAD
CAP SCREWS
NATIONAL COARSE

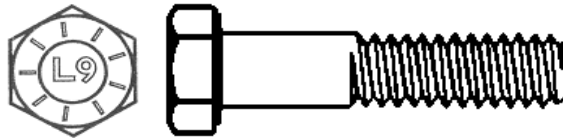

NOTRE CODE	DESCRIPTION	QTÉ/BOITE
OUR CODE	DESCRIPTION	QTY/BOX
BC825005	1/4-20 X 1/2	100
BC825007	1/4-20 X 3/4	100
BC825010	1/4-20 X 1	100
BC825012	1/4-20 X 1 1/4	100
BC825015	1/4-20 X 1 1/2	100
BC825017	1/4-20 X 1 3/4	100
BC825020	1/4-20 X 2	100
BC825025	1/4-20 X 2 1/2	100
BC825027	1/4-20 X 2 3/4	100
BC825030	1/4-20 X 3	100
BC825035	1/4-20 X 3 1/2	100
BC825040	1/4-20 X 4	100
BC825045	1/4-20 X 4 1/2	100
BC825055	1/4-20 X 5 1/2	100
BC831005	5/16-18 X 1/2	100
BC831006	5/16-18 X 5/8	100
BC831007	5/16-18 X 3/4	100
BC831010	5/16-18 X 1	100
BC831012	5/16-18 X 1 1/4	100
BC831015	5/16-28 X 1 1/2	100
BC831017	5/16-18 X 1 3/4	100
BC831020	5/16-18 X 2	100
BC831022	5/16-18 X 2 1/4	100
BC831025	5/16-18 X 2 1/2	100
BC831027	5/16-18 X 2 3/4	100
BC831030	5/16-18 X 3	100
BC831035	5/16-18 X 3 1/2	100
BC831040	5/16-18 X 4	100

AUTRES DIMENSIONS DISPONIBLES/OTHER DIMENSIONS ARE AVAILABLE



Tel.: (819) 346-2903 / (888) 345-2903 Fax.: (819) 346-3389

Email: distributeur@boulonsestrie.com

BOULONS À TÊTE
HEXAGONALE
GROS FILETS

ZINC / PLATED
L-9

HEX HEAD
CAP SCREWS
NATIONAL COARSE

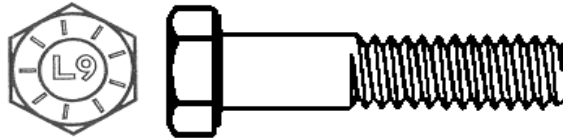

NOTRE CODE	DESCRIPTION	QTÉ/BOITE
OUR CODE	DESCRIPTION	QTY/BOX
BC831060	5/16-18 X 6	100
BC837005	3/8-16 X 1/2	100
*****	3/8-16 X 5/8	100
BC837007	3/8-16 X 3/4	100
BC837010	3/8-16 X 1	100
BC837012	3/8-16 X 1 1/4	100
BC837015	3/8-16 X 1 1/2	100
BC837017	3/8-16 X 1 3/4	100
BC837020	3/8-16 X 2	100
BC837022	3/8-16 X 2 1/4	100
BC837025	3/8-16 X 2 1/2	100
*****	3/8-16 X 2 3/4	100
BC837030	3/8-16 X 3	100
BC837035	3/8-16 X 3 1/2	100
BC837037	3/8-16 X 3 3/4	100
BC837040	3/8-16 X 4	100
BC837045	3/8-16 X 4 1/2	100
BC837050	3/8-16 X 5	100
BC837060	3/8-16 X 6	100
BC843007	7/16-14 X 3/4	100
BC843010	7/16-14 X 1	50
BC843012	7/16-14 X 1 1/4	50
BC843015	7/16-14 X 1 1/2	50
BC843017	7/16-14 X 1 3/4	50
BC843020	7/16-14 X 2	50
BC843025	7/16-14 X 2 1/2	50
BC843030	7/16-14 X 3	50
BC843035	7/16-14 X 3 1/2	50

AUTRES DIMENSIONS DISPONIBLES/OTHER DIMENSIONS ARE AVAILABLE



Tel.: (819) 346-2903 / (888) 345-2903 Fax.: (819) 346-3389

Email: distributeur@boulonsestrie.com

BOULONS À TÊTE
HEXAGONALE
GROS FILETS

ZINC / PLATED
L-9

HEX HEAD
CAP SCREWS
NATIONAL COARSE

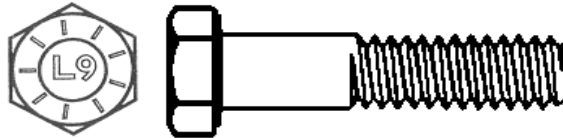

NOTRE CODE	DESCRIPTION	QTÉ/BOITE
OUR CODE	DESCRIPTION	QTY/BOX
BC843040	7/16-14 X 4	50
BC843050	7/16-14 X 5	50
BC843060	7/16-14 X 6	50
BC850007	1/2-13 X 3/4	50
BC850010	1/2-13 X 1	50
BC850012	1/2-13 X 1 1/4	50
BC850015	1/2-13 X 1 1/2	50
BC850020	1/2-13 X 2	50
BC850022	1/2-13 X 2 1/4	50
BC850025	1/2-13 X 2 1/2	50
BC850027	1/2-13 X 2 3/4	50
BC850030	1/2-13 X 3	50
BC850032	1/2-13 X 3 1/4	50
BC850035	1/2-13 X 3 1/2	50
BC850040	1/2-13 X 4	50
BC850045	1/2-13 X 4 1/2	50
BC850050	1/2-13 X 5	50
BC850060	1/2-13 X 6	50
BC850070	1/2-13 X 7	50
BC850080	1/2-13 X 8	50
BC856010	9/16-12 X 1	25
BC856015	9/16-12 X 1 1/2	25
BC856020	9/16-12 X 2	25
BC856025	9/16-12 X 2 1/2	25
BC856030	9/16-12 X 3	25
BC856035	9/16-12 X 3 1/2	25
BC856040	9/16-12 X 4	25
BC856045	9/16-12 X 4 1/2	25

AUTRES DIMENSIONS DISPONIBLES/OTHER DIMENSIONS ARE AVAILABLE



Tel.: (819) 346-2903 / (888) 345-2903 Fax.: (819) 346-3389

Email: distributeur@boulonsestrie.com

BOULONS À TÊTE
HEXAGONALE
GROS FILETS

ZINC / PLATED
L-9

HEX HEAD
CAP SCREWS
NATIONAL COARSE

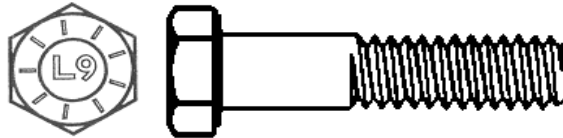

NOTRE CODE	DESCRIPTION	QTÉ/BOITE
OUR CODE	DESCRIPTION	QTY/BOX
BC856050	9/16-12 X 5	25
BC862010	5/8-11 X 1	25
BC862012	5/8-11 X 1 1/4	25
BC862015	5/8-11 X 1 1/2	25
BC862017	5/8-11 X 1 3/4	25
BC862020	5/8-11 X 2	25
BC862022	5/8-11 X 2 1/4	25
BC862025	5/8-11 X 2 1/2	25
BC862027	5/8-11 X 2 3/4	25
BC862030	5/8-11 X 3	25
BC862035	5/8-11 X 3 1/2	25
BC862040	5/8-11 X 4	25
BC862045	5/8-11 X 4 1/2	25
BC862050	5/8-11 X 5	25
BC862055	5/8-11 X 5 1/2	25
BC862060	5/8-11 X 6	25
BC862070	5/8-11 X 7	25
BC862080	5/8-11 X 8	25
BC862090	5/8-11 X 9	25
BC862100	5/8-11 X 10	25
BC862110	5/8-11 X 11	25
BC862120	5/8-11 X 12	25
BC875015	3/4-10 X 1 1/2	20
BC875017	3/4-10 X 1 3/4	20
BC875020	3/4-10 X 2	20
BC875022	3/4-10 X 2 1/4	20
BC875025	3/4-10 X 2 1/2	20
BC875027	3/4-10 X 2 3/4	20

AUTRES DIMENSIONS DISPONIBLES/OTHER DIMENSIONS ARE AVAILABLE



Tel.: (819) 346-2903 / (888) 345-2903 Fax.: (819) 346-3389

Email: distributeur@boulonsestrie.com

BOULONS À TÊTE
HEXAGONALE
GROS FILETS

ZINC / PLATED
L-9

HEX HEAD
CAP SCREWS
NATIONAL COARSE

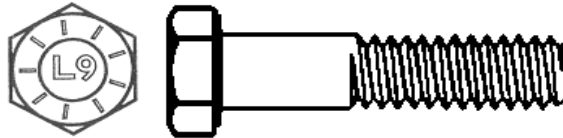

NOTRE CODE	DESCRIPTION	QTÉ/BOITE
OUR CODE	DESCRIPTION	QTY/BOX
BC875030	3/4-10 X 3	20
BC875035	3/4-10 X 3 1/2	20
BC875040	3/4-10 X 4	20
BC875045	3/4-10 X 4 1/2	20
BC875050	3/4-10 X 5	20
BC875055	3/4-10 X 5 1/2	20
BC875060	3/4-10 X 6	20
BC875070	3/4-10 X 7	20
BC875080	3/4-10 X 8	20
BC875090	3/4-10 X 9	20
BC875100	3/4-10 X 10	20
BC875110	3/4-10 X 11	20
BC875120	3/4-10 X 12	20
BC887015	7/8-9 X 1 1/2	20
BC887020	7/8-9 X 2	20
BC887025	7/8-9 X 2 1/2	20
BC887030	7/8-9 X 3	20
BC887035	7/8-9 X 3 1/2	20
BC887040	7/8-9 X 4	20
BC887045	7/8-9 X 4 1/2	20
BC887050	7/8-9 X 5	20
BC887055	7/8-9 X 5 1/2	20
BC887060	7/8-9 X 6	20
BC887070	7/8-9 X 7	20
BC887080	7/8-9 X 8	20
BC887090	7/8-9 X 9	20
BC887100	7/8-9 X 10	20
BC887110	7/8-9 X 11	20

AUTRES DIMENSIONS DISPONIBLES/OTHER DIMENSIONS ARE AVAILABLE



Tel.: (819) 346-2903 / (888) 345-2903 Fax.: (819) 346-3389

Email: distributeur@boulonsestrie.com

BOULONS À TÊTE
HEXAGONALE
GROS FILETS

ZINC / PLATED
L-9

HEX HEAD
CAP SCREWS
NATIONAL COARSE

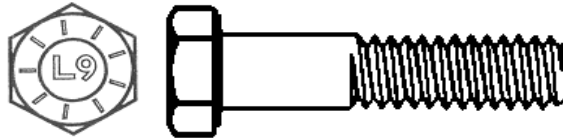

NOTRE CODE	DESCRIPTION	QTÉ/BOITE
OUR CODE	DESCRIPTION	QTY/BOX
BC887120	7/8-9 X 12	20
BC890015	1-8 X 1 1/2	20
BC890020	1-8 X 2	20
BC890025	1-8 X 2 1/2	20
BC890030	1-8 X 3	20
BC890035	1-8 X 3 1/2	20
BC890040	1-8 X 4	20
BC890045	1-8 X 4 1/2	20
BC890050	1-8 X 5	20
BC890055	1-8 X 5 1/2	20
BC890060	1-8 X 6	20
BC890070	1-8 X 7	20
BC890080	1-8 X 8	20
BC890090	1-8 X 9	20
BC890100	1-8 X 10	20
BC890110	1-8 X 11	20
BC890120	1-8 X 12	20
BC891030	1 1/8-7 X 3	20
BC891040	1 1/8-7 X 4	20
BC891050	1 1/8-7 X 5	20
BC892030	1 1/4-7 X 3	20
BC892045	1 1/4-7 X 4 1/2	20
BC892060	1 1/4-7 X 6	20
BC892070	1 1/4-12 X 7	20
BC892080	1 1/4-7 X 8	20
BC892090	1 1/4-7 X 9	20
BC892100	1 1/4-7 X 10	20

AUTRES DIMENSIONS DISPONIBLES/OTHER DIMENSIONS ARE AVAILABLE



Tel.: (819) 346-2903 / (888) 345-2903 Fax.: (819) 346-3389

Email: distributeur@boulonsestrie.com

BOULONS À TÊTE
HEXAGONALE
FILETS FINS

ZINC / PLATED
L-9

HEX HEAD
CAP SCREWS
NATIONAL FINE

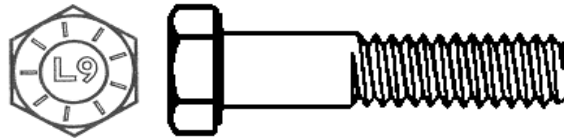

NOTRE CODE	DESCRIPTION	QTÉ/BOITE
OUR CODE	DESCRIPTION	QTY/BOX
BF825005	1/4-28 X 1/2	100
BF825007	1/4-28 X 3/4	100
BF825010	1/4-28 X 1	100
BF825012	1/4-28 X 1 1/4	100
BF825015	1/4-28 X 1 1/2	100
BF825017	1/4-28 X 1 3/4	100
BF825020	1/4-28 X 2	100
BF825022	1/4-28 X 2 1/4	100
BF825025	1/4-28 X 2 1/2	100
BF825027	1/4-28 X 2 3/4	100
BF825030	1/4-28 X 3	100
BF825032	1/4-28 X 3 1/4	100
BF825035	1/4-28 X 3 1/2	100
BF825037	1/4-28 X 3 3/4	100
BF825040	1/4-28 X 4	100
BF825045	1/4-28 X 4 1/2	100
BF825050	1/4-28 X 5	100
BF825055	1/4-28 X 5 1/2	100
BF825060	1/4-28 X 6	100
BF831005	5/16-24 X 1/2	100
BF831007	5/16-24 X 3/4	100
BF831010	5/16-24 X 1	100
BF831012	5/16-24 X 1 1/4	100
BF831015	5/16-24 X 1 1/2	100
BF831017	5/16-24 X 1 3/4	100
BF831020	5/16-24 X 2	100
BF831022	5/16-24 X 2 1/4	100
BF831025	5/16-24 X 2 1/2	100

AUTRES DIMENSIONS DISPONIBLES/OTHER DIMENSIONS ARE AVAILABLE



Tel.: (819) 346-2903 / (888) 345-2903 Fax.: (819) 346-3389

Email: distributeur@boulonsestrie.com

BOULONS À TÊTE
HEXAGONALE
FILETS FINS

ZINC / PLATED
L-9

HEX HEAD
CAP SCREWS
NATIONAL FINE

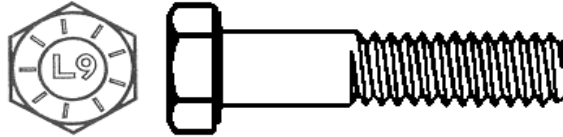

NOTRE CODE	DESCRIPTION	QTÉ/BOITE
OUR CODE	DESCRIPTION	QTY/BOX
BF831027	5/16-24 X 2 3/4	100
BF831030	5/16-24 X 3	100
BF831035	5/16-24 X 3 1/2	100
BF831037	5/16-24 X 3 3/4	100
BF831040	5/16-24 X 4	100
BF831045	5/16-24 X 4 1/2	100
BF831050	5/16-24 X 5	100
BF831055	5/16-24 X 5 1/2	100
BF831060	5/16-24 X 6	100
BF837005	3/8-24 X 1/2	100
BF837006	3/8-24 X 5/8	100
BF837007	3/8-24 X 3/4	100
BF837010	3/8-24 X 1	100
BF837012	3/8-24 X 1 1/4	100
BF837015	3/8-24 X 1 1/2	100
BF837017	3/8-24 X 1 3/4	100
BF837020	3/8-24 X 2	100
BF837022	3/8-24 X 2 1/4	100
BF837025	3/8-24 X 2 1/2	100
BF837027	3/8-24 X 2 3/4	100
BF837030	3/8-24 X 3	100
BF837032	3/8-24 X 3 1/4	100
BF837035	3/8-24 X 3 1/2	100
BF837037	3/8-24 X 3 3/4	100
BF837040	3/8-24 X 4	100
BF837045	3/8-24 X 4 1/2	100
BF837050	3/8-24 X 5	100
BF837055	3/8-24 X 5 1/2	100

AUTRES DIMENSIONS DISPONIBLES/OTHER DIMENSIONS ARE AVAILABLE



Tel.: (819) 346-2903 / (888) 345-2903 Fax.: (819) 346-3389

Email: distributeur@boulonsestrie.com

BOULONS À TÊTE
HEXAGONALE
FILETS FINS

ZINC / PLATED
L-9

HEX HEAD
CAP SCREWS
NATIONAL FINE



NOTRE CODE	DESCRIPTION	QTÉ/BOITE
OUR CODE	DESCRIPTION	QTY/BOX
BF837060	3/8-24 X 6	100
BF843007	7/16-20 X 3/4	100
BF843010	7/16-20 X 1	50
BF843012	7/16-20 X 1 1/4	50
BF843015	7/16-20 X 1 1/2	50
BF843017	7/16-20 X 1 3/4	50
BF843020	7/16-20 X 2	50
BF843022	7/16-20 X 2 1/4	50
BF843025	7/16-20 X 2 1/2	50
BF843030	7/16-20 X 3	50
BF843032	7/16-20 X 3 1/4	50
BF843035	7/16-20 X 3 1/2	50
BF843040	7/16-20 X 4	50
BF843045	7/16-20 X 4 1/2	50
BF843050	7/16-20 X 5	50
BF843055	7/16-20 X 5 1/2	50
BF843060	7/16-20 X 6	50
BF850007	1/2-20 X 3/4	50
BF850010	1/2-20 X 1	50
BF850012	1/2-20 X 1 1/4	50
BF850015	1/2-20 X 1 1/2	50
BF850017	1/2-20 X 1 3/4	50
BF850020	1/2-20 X 2	50
BF850022	1/2-20 X 2 1/4	50
BF850025	1/2-20 X 2 1/2	50
BF850027	1/2-20 X 2 3/4	50
BF850030	1/2-20 X 3	50
BF850032	1/2-20 X 3 1/4	50

AUTRES DIMENSIONS DISPONIBLES/OTHER DIMENSIONS ARE AVAILABLE



Tel.: (819) 346-2903 / (888) 345-2903 Fax.: (819) 346-3389

Email: distributeur@boulonsestrie.com

A-67

BOULONS À TÊTE
HEXAGONALE
FILETS FINS

ZINC / PLATED
L-9

HEX HEAD
CAP SCREWS
NATIONAL FINE



NOTRE CODE	DESCRIPTION	QTÉ/BOITE
OUR CODE	DESCRIPTION	QTY/BOX
BF850035	1/2-20 X 3 1/2	50
BF850037	1/2-20 X 3 3/4	50
BF850040	1/2-20 X 4	50
BF850045	1/2-20 X 4 1/2	50
BF850050	1/2-20 X 5	50
BF850060	1/2-20 X 6	50
BF850070	1/2-20 X 7	50
BF850080	1/2-20 X 8	50
BF850120	1/2-20 X 12	50
BF856010	9/16-18 X 1	25
BF856012	9/16-18 X 1 1/4	25
BF856015	9/16-18 X 1 1/2	25
BF856017	9/16-18 X 1 3/4	25
BF856020	9/16-18 X 2	25
BF856025	9/16-18 X 2 1/2	25
BF856030	9/16-18 X 3	25
BF856035	9/16-18 X 3 1/2	25
BF856040	9/16-18 X 4	25
BF856045	9/16-18 X 4 1/2	25
BF856050	9/16-18 X 5	25
BF856055	9/16-18 X 5 1/2	25
BF862010	5/8-18 X 1	25
BF862012	5/8-18 X 1 1/4	25
BF862015	5/8-18 X 1 1/2	25
BF862017	5/8-18 X 1 3/4	25
BF862020	5/8-18 X 2	25
BF862022	5/8-18 X 2 1/4	25
BF862025	5/8-18 X 2 1/2	25

AUTRES DIMENSIONS DISPONIBLES/OTHER DIMENSIONS ARE AVAILABLE



Tel.: (819) 346-2903 / (888) 345-2903 Fax.: (819) 346-3389

Email: distributeur@boulonsestrie.com

A-68

BOULONS À TÊTE
HEXAGONALE
FILETS FINS

ZINC / PLATED
L-9

HEX HEAD
CAP SCREWS
NATIONAL FINE

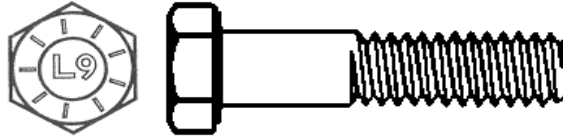

NOTRE CODE	DESCRIPTION	QTÉ/BOITE
OUR CODE	DESCRIPTION	QTY/BOX
BF862027	5/8-18 X 2 3/4	25
BF862030	5/8-18 X 3	25
BF862035	5/8-18 X 3 1/2	25
BF862040	5/8-18 X 4	25
BF862045	5/8-18 X 4 1/2	25
BF862050	5/8-18 X 5	25
BF862055	5/8-18 X 5 1/2	25
BF862060	5/8-18 X 6	25
BF862070	5/8-18 X 70	25
BF862080	5/8-18 X 8	25
BF862090	5/8-18 X 9	25
BF862100	5/8-18 X 10	25
BF862110	5/8-18 X 11	25
BF862120	5/8-18 X 12	25
BF875015	3/4-16 X 1 1/2	20
BF875017	3/4-16 X 1 3/4	20
BF875020	3/4-16 X 2	20
BF875022	3/4-16 X 2 1/4	20
BF875025	3/4-16 X 2 1/2	20
BF875027	3/4-16 X 2 3/4	20
BF875030	3/4-16 X 3	20
BF875035	3/4-16 X 3 1/2	20
BF875040	3/4-16 X 4	20
BF875045	3/4-16 X 4 1/2	20
BF875050	3/4-16 X 5	20
BF875055	3/4-16 X 5 1/2	20
BF875060	3/4-16 X 6	20
BF875070	3/4-16 X 7	20

AUTRES DIMENSIONS DISPONIBLES/OTHER DIMENSIONS ARE AVAILABLE



Tel.: (819) 346-2903 / (888) 345-2903 Fax.: (819) 346-3389

Email: distributeur@boulonstrie.com

BOULONS À TÊTE
HEXAGONALE
FILETS FINS

ZINC / PLATED
L-9

HEX HEAD
CAP SCREWS
NATIONAL FINE

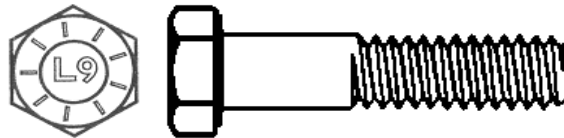

NOTRE CODE	DESCRIPTION	QTÉ/BOITE
OUR CODE	DESCRIPTION	QTY/BOX
BF875080	3/4-16 X 8	20
BF875090	3/4-16 X 9	20
BF875100	3/4-16 X 10	20
BF875110	3/4-16 X 11	20
BF875120	3/4-16 X 12	20
BF887015	7/8-14 X 1 1/2	20
BF887020	7/8-14 X 2	20
BF887025	7/8-14 X 2 1/2	20
BF887030	7/8-14 X 3	20
BF887035	7/8-14 X 3 1/2	20
BF887040	7/8-14 X 4	20
BF887045	7/8-14 X 4 1/2	20
BF887047	7/8-14 X 4 3/4	20
BF887050	7/8-14 X 5	20
BF887055	7/8-14 X 5 1/2	20
BF887060	7/8-14 X 6	20
BF887070	7/8-14 X 7	20
BF887080	7/8-14 X 8	20
BF887090	7/8-14 X 9	20
BF887100	7/8-14 X 10	20
BF887110	7/8-14 X 11	20
BF887120	7/8-14 X 12	20
BF890020	1-14 X 2	20
BF890022	1-14 X 2 1/4	20
BF890025	1-14 X 2 1/2	20
BF890030	1-14 X 3	20
BF890035	1-14 X 3 1/2	20
BF890040	1-14 X 4	20

AUTRES DIMENSIONS DISPONIBLES/OTHER DIMENSIONS ARE AVAILABLE



Tel.: (819) 346-2903 / (888) 345-2903 Fax.: (819) 346-3389

Email: distributeur@boulonsestrie.com

A-70

BOULONS À TÊTE
HEXAGONALE
FILETS FINS

ZINC / PLATED
L-9

HEX HEAD
CAP SCREWS
NATIONAL FINE

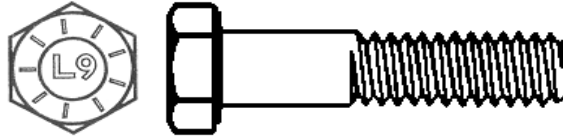

NOTRE CODE	DESCRIPTION	QTÉ/BOITE
OUR CODE	DESCRIPTION	QTY/BOX
BF890045	1-14 X 4 1/2	20
BF890050	1-14 X 5	20
BF890055	1-14 X 5 1/2	20
BF890060	1-14 X 6	20
BF890070	1-14 X 7	20
BF890080	1-14 X 8	20
BF890090	1-14 X 9	20
BF890100	1-14 X 10	20
BF890110	1-14 X 11	20
BF890120	1-14 X 12	20
BF891030	1 1/8-12 X 3	20
BF891035	1 1/8-12 X 3 1/2	20
BF891040	1 1/8-12 X 4	20
BF891050	1 1/8-12 X 5	20
BF892030	1 1/4-12 X 3	20
BF892045	1 1/4-12 X 4 1/2	20
BF892060	1 1/4-12 X 6	20
BF892070	1 1/4-12 X 7	20
BF892080	1 1/4-12 X 8	20
BF892090	1 1/4-12 X 9	20
BF892100	1 1/4-12 X 10	20

AUTRES DIMENSIONS DISPONIBLES/OTHER DIMENSIONS ARE AVAILABLE



Tel.: (819) 346-2903 / (888) 345-2903 Fax.: (819) 346-3389

Email: distributeur@boulonsestrie.com

A-71

GRADE 2

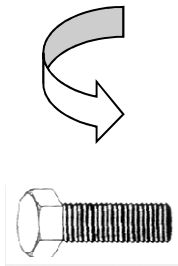

NOTRE CODE GRADE 2	DESCRIPTION
OUR CODE GRADE 2	DESCRIPTION
BT425012	1/4 X 1 1/4
BT425015	1/4 X 1 1/2
BT425017	1/4 X 1 3/4
BT425020	1/4 X 2
BT425025	1/4 X 2 1/2
BT425030	1/4 X 3
BT425035	1/4 X 3 1/2
BT431015	5/16 X 1 1/2
BT431020	5/16 X 2
BT431025	5/16 X 2 1/2
BT437015	3/8 X 1 1/2
BT437020	3/8 X 2
BT437022	3/8 X 2 1/4
BT437025	3/8 X 2 1/2
BT443017	7/16 X 1 3/4
BT450025	1/2 X 2 1/2
BT450030	1/2 X 3
BT475030	3/4 X 3

NOIR EST
DISPONIBLE /
BARE IS
AVAILABLE

GRADE 5

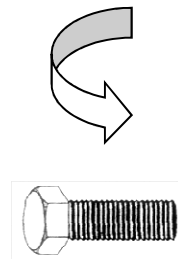

NOTRE CODE GRADE 5	DESCRIPTION
OUR CODE GRADE 5	DESCRIPTION
BT625010	1/4 X 1
BT625020	1/4 X 2
BT631010	5/16 X 1
BT631015	5/16 X 1 1/2
BT631017	5/16 X 1 3/4
BT631020	5/16 X 2
BT637030	3/8 X 3
BT650025	1/2 X 2 1/2
BT650030	1/2 X 3
BT650035	1/2 X 3 1/2
BT650045	1/2 X 4 1/2
BT650070	1/2 X 7
BT662050	5/8 X 5
BT675035	3/4 X 3 1/2
BT675045	3/4 X 4 1/2

NOIR EST
DISPONIBLE /
BARE IS
AVAILABLE



DIMENSIONS DES BOULONS DE CONSTRUCTION DIMENSIONS OF STRUCTURAL BOLTS

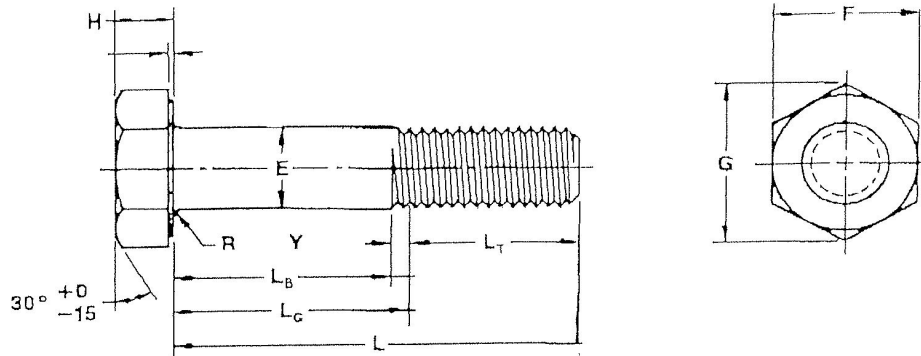

Nominal Size or Basic Product Dia.	E		F			G		H			R		Lt	Y	Runout
	Body Dia.		Width Across Flats			Width Across Corners		Height			Radius of Fillet		Thread Length	Transition Thread Lg	of Bearing Surface FIM
	Max	Min	Basic	Max	Min	Max	Min	Basic	Max	Min	Max	Min	Basic	Max	Max
1/2 0.5000	0.515	0.482	7/8.	0.875	0.850	1.010	0.969	5/16.	0.323	0.302	0.031	0.009	1.00	0.19	0.016
5/8 0.6250	0.642	0.605	1-1/16.	1.062	1.031	1.227	1.175	25/64	0.403	0.378	0.062	0.021	1.25	0.22	0.019
3/4 0.7500	0.768	0.729	1-1/4.	1.250	1.250	1.443	1.383	15/32	0.483	0.455	0.062	0.021	1.38	0.25	0.022
7/8 0.8750	0.895	0.852	1-7/16.	1.438	1.438	1.660	1.589	35/64	0.563	0.531	0.062	0.031	1.50	0.28	0.025
1 1.0000	1.022	0.976	1-5/8.	1.625	1.575	1.876	1.796	39/64	0.827	0.591	0.093	0.062	1.75	0.31	0.028
1-1/8 1.1250	1.149	1.098	1-13/16.	1.812	1.756	2.093	2.002	11/16.	0.718	0.658	0.093	0.062	2.00	0.34	0.032
1-1/4 1.2500	1.277	1.223	2	2.000	1.938	2.309	2.209	25/32	0.813	0.749	0.093	0.062	2.00	0.38	0.035
1-3/8 1.3750	1.404	1.345	2-3/16.	2.188	2.119	2.526	2.416	27/32	0.878	0.810	0.093	0.062	2.25	0.44	0.038
1-1/2 1.5000	1.531	1.470	2-3/8.	2.375	2.300	2.742	2.622	15/16	0.974	0.902	0.093	0.062	2.25	0.44	0.041



Tel.: (819) 346-2903 / (888) 345-2903 Fax.: (819) 346-3389

Email: distributeur@boulonstrie.com

BOULONS DE
CONSTRUCTION
À TÊTE HEXAGONALE
AVEC ÉCROUS ET RONDELLES

A-325 / ASSY
NOIR / BARE

STRUCTURAL BOLTS
HEXAGONAL HEAD
C/W WASHERS AND NUTS

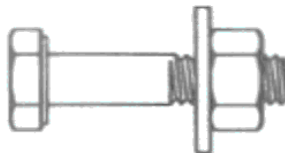

NOTRE CODE	DESCRIPTION	QTÉ/BARIL
OUR CODE	DESCRIPTION	QTY/BARREL
BS550012	1/2-13 X 1 1/4	900
BS550015	1/2-13 X 1 1/2	800
BS550017	1/2-13 X 1 3/4	750
BS550020	1/2-13 X 2	700
BS550022	1/2-13 X 2 1/4	650
BS550025	1/2-13 X 2 1/2	600
*****	1/2-13 X 2 3/4	550
*****	1/2-13 X 3	525
*****	1/2-13 X 3 1/4	500
*****	1/2-13 X 3 1/2	475
*****	1/2-13 X 3 3/4	450
*****	1/2-13 X 4	400
*****	1/2-13 X 5	300
*****	1/2-13 X 6	200
*****	1/2-13 X 7	150
*****	1/2-13 X 8	100
BS562012	5/8-11 X 1 1/4	500
BS562015	5/8-11 X 1 1/2	500
BS562017	5/8-11 X 1 3/4	500
BS562020	5/8-11 X 2	450
BS562022	5/8-11 X 2 1/4	400
BS562025	5/8-11 X 2 1/2	400
*****	5/8-11 X 2 3/4	350
BS562030	5/8-11 X 3	330
BS562032	5/8-11 X 3 1/4	300

NOTRE CODE	DESCRIPTION	QTÉ/BARIL
OUR CODE	DESCRIPTION	QTY/BARREL
*****	5/8-11 X 3 1/2	300
*****	5/8-11 X 3 3/4	260
BS562040	5/8-11 X 4	260
BS562042	5/8-11 X 4 1/4	250
BS562045	5/8-11 X 4 1/2	230
*****	5/8-11 X 4 3/4	230
*****	5/8-11 X 5	230
*****	5/8-11 X 5 1/2	210
*****	5/8-11 X 6	190
*****	5/8-11 X 6 1/2	175
*****	5/8-11 X 7	150
BS562075	5/8-11 X 7 1/2	125
*****	5/8-11 X 8	100
BS575015	3/4-10 X 1 1/2	340
BS575017	3/4-10 X 1 3/4	300
BS575020	3/4-10 X 2	300
BS575022	3/4-10 X 2 1/4	270
BS575025	3/4-10 X 2 1/2	260
BS575027	3/4-10 X 2 3/4	250
BS575030	3/4-10 X 3	230
BS575032	3/4-10 X 3 1/4	220
BS575035	3/4-10 X 3 1/2	210
BS575037	3/4-10 X 3 3/4	200
BS575040	3/4-10 X 4	190
*****	3/4-10 X 4 1/4	170



Tel.: (819) 346-2903 / (888) 345-2903 Fax.: (819) 346-3389

Email: distributeur@boulonsestrie.com

BOULONS DE
CONSTRUCTION
À TÊTE HEXAGONALE
AVEC ÉCROUS ET RONDELLES

A-325 / ASSY
NOIR / BARE

STRUCTURAL BOLTS
HEXAGONAL HEAD
C/W WASHERS AND NUTS

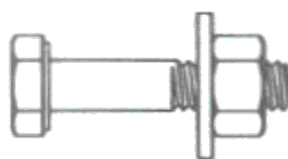

NOTRE CODE	DESCRIPTION	QTÉ/BARIL
OUR CODE	DESCRIPTION	QTY/BARREL
*****	3/4-10 X 4 1/2	170
*****	3/4-10 X 4 3/4	150
BS575050	3/4-10 X 5	130
*****	3/4-10 X 5 1/4	130
BS575055	3/4-10 X 5 1/2	130
BS575060	3/4-10 X 6	130
*****	3/4-10 X 6 1/2	120
*****	3/4-10 X 7	110
*****	3/4-10 X 7 1/2	100
*****	3/4-10 X 8	90
BS587017	7/8-9 X 1 3/4	220
BS587020	7/8-9 X 2	200
BS587022	7/8-9 X 2 1/4	190
BS587025	7/8-9 X 2 1/2	180
BS587027	7/8-9 X 2 3/4	170
BS587030	7/8-9 X 3	160
BS587032	7/8-9 X 3 1/4	150
BS587035	7/8-9 X 3 1/2	150
BS587037	7/8-9 X 3 3/4	140
BS587040	7/8-9 X 4	130
BS587042	7/8-9 X 4 1/4	120
BS587045	7/8-9 X 4 1/2	120
BS587047	7/8-9 X 4 3/4	110
*****	7/8-9 X 5	110
*****	7/8-9 X 5 1/4	100

NOTRE CODE	DESCRIPTION	QTÉ/BARIL
OUR CODE	DESCRIPTION	QTY/BARREL
*****	7/8-9 X 5 1/2	100
*****	7/8-9 X 5 3/4	90
*****	7/8-9 X 6	90
BS587065	7/8-9 X 6 1/2	90
*****	7/8-9 X 7	75
*****	7/8-9 X 7 1/2	70
*****	7/8-9 X 8	65
BS590020	1-8 X 2	150
BS590022	1-8 X 2 1/4	140
BS590025	1-8 X 2 1/2	140
BS590027	1-8 X 2 3/4	130
BS590030	1-8 X 3	130
BS590032	1-8 X 3 1/4	120
BS590035	1-8 X 3 1/2	110
BS590037	1-8 X 3 3/4	110
BS590040	1-8 X 4	100
BS590042	1-8 X 4 1/4	90
BS590045	1-8 X 4 1/2	90
*****	1-8 X 4 3/4	85
*****	1-8 X 5	85
*****	1-8 X 5 1/4	80
*****	1-8 X 5 1/2	80
*****	1-8 X 5 3/4	70
*****	1-8 X 6	70
*****	1-8 X 6 1/2	65



Tel.: (819) 346-2903 / (888) 345-2903 Fax.: (819) 346-3389

Email: distributeur@boulonsestrie.com

BOULONS À TÊTE
 HEXAGONALE
 ACIER INOXYDABLE
 GROS FILETS

SS-304
 18-8

HEX HEAD
 CAP SCREWS
 STAINLESS STEEL
 NATIONAL COARSE

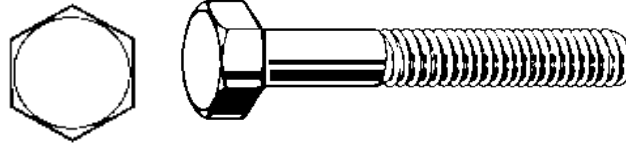

NOTRE CODE	DESCRIPTION	QTÉ/BOITE
OUR CODE	DESCRIPTION	QTY/BOX
BS108007	8-32 X 3/4	100
BS108010	8-32 X 1	100
BS108012	8-32 X 1 1/4	100
BS110005	10-24 X 1/2	100
BS110007	10-24 X 3/4	100
BS110010	10-24 X 1	100
BS110015	10-24 X 1 1/2	100
BS125004	1/4-20 X 3/8	100
BS125005	1/4-20 X 1/2	100
BS125006	1/4-20 X 5/8	100
BS125007	1/4-20 X 3/4	100
BS125008	1/4-20 X 7/8	100
BS125010	1/4-20 X 1	100
BS125012	1/4-20 X 1 1/4	100
BS125015	1/4-20 X 1 1/2	100
BS125017	1/4-20 X 1 3/4	100
BS125020	1/4-20 X 2	100
BS125022	1/4-20 X 2 1/4	100
BS125025	1/4-20 X 2 1/2	100
BS125027	1/4-20 X 2 3/4	100
BS125030	1/4-20 X 3	100
BS125032	1/4-20 X 3 1/4	100
BS125035	1/4-20 X 3 1/2	100
BS125037	1/4-20 X 3 3/4	100
BS125040	1/4-20 X 4	100
BS125045	1/4-20 X 4 1/2	100
BS125050	1/4-20 X 5	100
BS131004	5/16-18 X 3/8	100

AUTRES DIMENSIONS DISPONIBLES/OTHER DIMENSIONS ARE AVAILABLE

BOULONS À TÊTE
 HEXAGONALE
 ACIER INOXYDABLE
 GROS FILETS

SS-304
 18-8

HEX HEAD
 CAP SCREWS
 STAINLESS STEEL
 NATIONAL COARSE

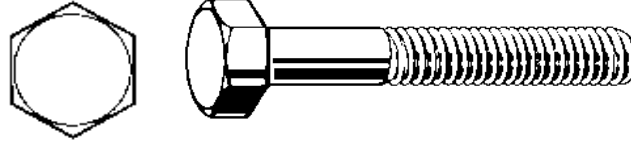

NOTRE CODE	DESCRIPTION	QTÉ/BOITE
OUR CODE	DESCRIPTION	QTY/BOX
BS131005	5/16-18 X 1/2	100
BS131006	5/16-18 X 5/8	100
BS131007	5/16-18 X 3/4	100
BS131008	5/16-18 X 7/8	100
BS131010	5/16-18 X 1	100
BS131012	5/16-18 X 1 1/4	100
BS131015	5/16-18 X 1 1/2	100
BS131017	5/16-18 X 1 3/4	100
BS131020	5/16-18 X 2	100
BS131022	5/16-18 X 2 1/4	100
BS131025	5/16-18 X 2 1/2	100
BS131030	5/16-18 X 3	100
BS131035	5/16-18 X 3 1/2	100
BS131040	5/16-18 X 4	100
BS131045	5/16-18 X 4 1/2	100
BS131055	5/16-18 X 5 1/2	100
BS131060	5/16-18 X 6	100
BS137005	3/8-16 X 1/2	100
BS137006	3/8-16 X 5/8	100
BS137007	3/8-16 X 3/4	100
BS137008	3/8-16 X 7/8	100
BS137010	3/8-16 X 1	100
BS137012	3/8-16 X 1 1/4	100
BS137015	3/8-16 X 1 1/2	100
BS137017	3/8-16 X 1 3/4	100
BS137020	3/8-16 X 2	100
BS137022	3/8-16 X 2 1/4	100
BS137025	3/8-16 X 2 1/2	100

AUTRES DIMENSIONS DISPONIBLES/OTHER DIMENSIONS ARE AVAILABLE

BOULONS À TÊTE
 HEXAGONALE
 ACIER INOXYDABLE
 GROS FILETS

SS-304
 18-8

HEX HEAD
 CAP SCREWS
 STAINLESS STEEL
 NATIONAL COARSE

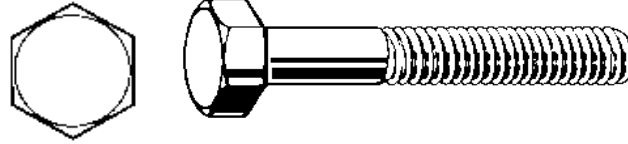

NOTRE CODE	DESCRIPTION	QTÉ/BOITE
OUR CODE	DESCRIPTION	QTY/BOX
BS137027	3/8-16 X 2 3/4	100
BS137030	3/8-16 X 3	100
BS137035	3/8-16 X 3 1/2	100
BS137037	3/8-16 X 3 3/4	100
BS137040	3/8-16 X 4	100
BS137045	3/8-16 X 4 1/2	100
BS137050	3/8-16 X 5	100
BS137055	3/8-16 X 5 1/2	100
BS137060	3/8-16 X 6	100
BS137070	3/8-16 X 7	100
BS137080	3/8-16 X 8	100
BS143010	7/16-14 X 1	50
BS143012	7/16-14 X 1 1/4	50
BS143015	7/16-14 X 1 1/2	50
BS143017	7/16-14 X 1 3/4	50
BS143020	7/16-14 X 2	50
BS143022	7/16-14 X 2 1/4	50
BS143025	7/16-14 X 2 1/2	50
BS143030	7/16-14 X 3	50
BS143040	7/16-14 X 4	50
BS150005	1/2-13 X 1/2	50
BS150006	1/2-13 X 5/8	50
BS150007	1/2-13 X 3/4	50
BS150010	1/2-13 X 1	50
BS150012	1/2-13 X 1 1/4	50
BS150015	1/2-13 X 1 1/2	50
BS150017	1/2-13 X 1 3/4	50
BS150020	1/2-13 X 2	50

AUTRES DIMENSIONS DISPONIBLES/OTHER DIMENSIONS ARE AVAILABLE

BOULONS À TÊTE
 HEXAGONALE
 ACIER INOXYDABLE
 GROS FILETS

SS-304
 18-8

HEX HEAD
 CAP SCREWS
 STAINLESS STEEL
 NATIONAL COARSE

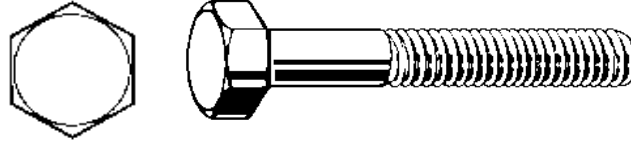

NOTRE CODE	DESCRIPTION	QTÉ/BOITE
OUR CODE	DESCRIPTION	QTY/BOX
BS150022	1/2-13 X 2 1/4	50
BS150025	1/2-13 X 2 1/2	50
BS150030	1/2-13 X 3	50
BS150032	1/2-13 X 3 1/4	50
BS150035	1/2-13 X 3 1/2	50
BS150040	1/2-13 X 4	50
BS150045	1/2-13 X 4 1/2	50
BS150050	1/2-13 X 5	50
BS150055	1/2-13 X 5 1/2	50
BS150060	1/2-13 X 6	50
BS150070	1/2-13 X 7	50
BS150075	1/2-13 X 7 1/2	50
BS150080	1/2-13 X 8	50
BS162010	5/8-11 X 1	25
BS162012	5/8-11 X 1 1/4	25
BS162015	5/8-11 X 1 1/2	25
BS162017	5/8-11 X 1 3/4	25
BS162020	5/8-11 X 2	25
BS162022	5/8-11 X 2 1/4	25
BS162025	5/8-11 X 2 1/2	25
BS162027	5/8-11 X 2 3/4	25
BS162030	5/8-11 X 3	25
BS162032	5/8-11 X 3 1/4	25
BS162035	5/8-11 X 3 1/2	25
BS162040	5/8-11 X 4	25
BS162045	5/8-11 X 4 1/2	25
BS162050	5/8-11 X 5	25
BS162055	5/8-11 X 5 1/2	25

AUTRES DIMENSIONS DISPONIBLES/OTHER DIMENSIONS ARE AVAILABLE

BOULONS À TÊTE
 HEXAGONALE
 ACIER INOXYDABLE
 GROS FILETS

SS-304
 18-8

HEX HEAD
 CAP SCREWS
 STAINLESS STEEL
 NATIONAL COARSE

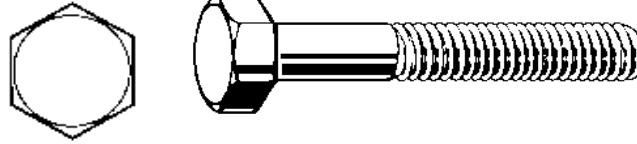

NOTRE CODE	DESCRIPTION	QTÉ/BOITE
OUR CODE	DESCRIPTION	QTY/BOX
BS162060	5/8-11 X 6	25
BS162065	5/8-11 X 6 1/2	25
BS175012	3/4-10 X 1 1/4	20
BS175015	3/4-10 X 1 1/2	20
BS175017	3/4-10 X 1 3/4	20
BS175020	3/4-10 X 2	20
BS175022	3/4-10 X 2 1/4	20
BS175025	3/4-10 X 2 1/2	20
BS175027	3/4-10 X 2 3/4	20
BS175030	3/4-10 X 3	20
BS175032	3/4-10 X 3 1/4	20
BS175035	3/4-10 X 3 1/2	20
BS175037	3/4-10 X 3 3/4	20
BS175040	3/4-10 X 4	20
BS175045	3/4-10 X 4 1/2	20
BS175050	3/4-10 X 5	20
BS175060	3/4-10 X 6	20
BS175065	3/4-10 X 6 1/2	20
BS175080	3/4-10 X 8	20
BS187020	7/8-9 X 2	20
BS187022	7/8-9 X 2 1/4	20
BS187025	7/8-9 X 2 1/2	20
BS187030	7/8-9 X 3	20
BS187035	7/8-9 X 3 1/2	20
BS187037	7/8-9 X 3 3/4	20
BS187040	7/8-9 X 4	20
BS187055	7/8-9 X 5 1/2	20
BS190020	1-8 X 2	20

AUTRES DIMENSIONS DISPONIBLES/OTHER DIMENSIONS ARE AVAILABLE

BOULONS À TÊTE
 HEXAGONALE
 ACIER INOXYDABLE
 GROS FILETS

SS-304
 18-8

HEX HEAD
 CAP SCREWS
 STAINLESS STEEL
 NATIONAL COARSE

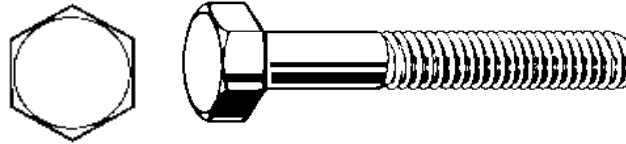

NOTRE CODE	DESCRIPTION	QTÉ/BOITE
OUR CODE	DESCRIPTION	QTY/BOX
BS190025	1-8 X 2 1/2	20
BS190027	1-8 X 2 3/4	20
BS190030	1-8 X 3	20
BS190035	1-8 X 3 1/2	20
BS190040	1-8 X 4	20
BS190045	1-8 X 4 1/2	20
BS190060	1-8 X 6	20
BS191030	1 1/8-7 X 3	15
BS191035	1 1/8-7 X 3 1/2	15
BS191040	1 1/8-7 X 4	15
BS192035	1 1/4-7 X 3 1/2	15
BS192040	1 1/4-7 X 4	15
BS192045	1 1/4-7 X 4 1/2	15

AUTRES DIMENSIONS DISPONIBLES/OTHER DIMENSIONS ARE AVAILABLE

AUSSI DISPONIBLE / ALSO AVAILABLE
 BOULONS HEXAGONAUX / HEX BOLTS:
 FILETS FINS / FINE THREAD: NF SS304 & SS316

PROPRIÉTÉS DE L'ACIER INOXYDABLE 304 / STAINLESS STEEL PROPERTIES

CARBONE / CARBON (max.) 0.08
 MAGNÉSIUM / MANGANESE (max.) 2.00
 SILICONE / SILICON / (max.) 1.00
 CHROME / CHROMIUM 18.00/20.00
 NICKEL / NICKEL 8.00/12.00



Tel.: (819) 346-2903 / (888) 345-2903 Fax.: (819) 346-3389
 Email: distributeur@boulonsestrie.com

BOULONS À TÊTE
HEXAGONALE
GROS FILETS

SS-316

HEX HEAD
CAP SCREWS
NATIONAL COARSE



ACIER INOXYDABLE

STAINLESS STEEL

NOTRE CODE	DESCRIPTION	QTÉ/BOITE
OUR CODE	DESCRIPTION	QTY/BOX
BS225005	1/4-20 X 1/2	100
BS225007	1/4-20 X 3 /4	100
BS225010	1/4-20 X 1	100
BS225012	1/4-20 X 1 1/4	100
BS225015	1/4-20 X 1 1/2	100
BS225020	1/4-20 X 2	100
BS225022	1/4-20 X 2 1/4	100
BS225025	1/4-20 X 2 1/2	100
BS225030	1/4-20 X 3	100
BS231007	5/16-18 X 3/4	100
BS231010	5/16-18 X 1	100
BS231012	5/16-18 X 1 1/4	100
BS231015	5/16-18 X 1 1/2	100
BS231017	5/16-18 X 1 3/4	100
BS231020	5/16-18 X 2	100
BS231022	5/16-18 X 2 1/4	100
BS231025	5/16-18 X 2 1/2	100
BS231035	5/16-18 X 3 1/2	100
*****	5/16-18 X 4	100
BS237007	3/8-16 X 3/4	100
BS237010	3/8-16 X 1	100
BS237012	3/8-16 X 1 1/4	100
BS237015	3/8-16 X 1 1/2	100
BS237017	3/8-16 X 1 3/4	100
BS237020	3/8-16 X 2	100
BS237025	3/8-16 X 2 1/2	100
BS237030	3/8-16 X 3	100
BS237035	3/8-16 X 3 1/2	100

AUTRES DIMENSIONS DISPONIBLES/OTHER DIMENSIONS ARE AVAILABLE



Tel.: (819) 346-2903 / (888) 345-2903 Fax.: (819) 346-3389

Email: distributeur@boulonsestrie.com

A-83

BOULONS À TÊTE
HEXAGONALE
GROS FILETS

SS-316

HEX HEAD
CAP SCREWS
NATIONAL COARSE



ACIER INOXYDABLE

STAINLESS STEEL

NOTRE CODE	DESCRIPTION	QTÉ/BOITE
OUR CODE	DESCRIPTION	QTY/BOX
BS237040	3/8-16 X 4	100
BS237045	3/8-16 X 4 1/2	100
BS250005	1/2-13 X 1/2	50
BS250007	1/2-13 X 3/4	50
BS250010	1/2-13 X 1	50
BS250012	1/2-13 X 1 1/4	50
BS250015	1/2-13 X 1 1/2	50
BS250017	1/2-13 X 1 3/4	50
BS250020	1/2-13 X 2	50
BS250022	1/2-13 X 2 1/4	50
BS250025	1/2-13 X 2 1/2	50
BS250030	1/2-13 X 3	50
BS250032	1/2-13 X 3 1/4	50
BS250035	1/2-13 X 3 1/2	50
BS250040	1/2-13 X 4	50
BS250045	1/2-13 X 4 1/2	50
BS250050	1/2-13 X 5	50
*****	1/2-13 X 6	50
BS262010	5/8-11 X 1	25
BS262012	5/8-11 X 1 1/4	25
BS262015	5/8-11 X 1 1/2	25
BS262017	5/8-11 X 1 3/4	25
BS262020	5/8-11 X 2	25
BS262022	5/8-11 X 2 1/4	25
BS262025	5/8-11 X 2 1/2	25
BS262027	5/8-11 X 2 3/4	25
BS262030	5/8-11 X 3	25
BS262032	5/8-11 X 3 1/4	25

AUTRES DIMENSIONS DISPONIBLES/OTHER DIMENSIONS ARE AVAILABLE



Tel.: (819) 346-2903 / (888) 345-2903 Fax.: (819) 346-3389
Email: distributeur@boulonstrie.com

A-84

BOULONS À TÊTE
HEXAGONALE
GROS FILETS

SS-316

HEX HEAD
CAP SCREWS
NATIONAL COARSE



ACIER INOXYDABLE

STAINLESS STEEL

NOTRE CODE	DESCRIPTION	QTÉ/BOITE
OUR CODE	DESCRIPTION	QTY/BOX
BS262035	5/8-11 X 3 1/2	25
BS262040	5/8-11 X 4	25
BS262045	5/8-11 X 4 1/2	25
BS262050	5/8-11 X 5	25
BS262060	5/8-11 X 6	25
BS262065	5/8-11 X 6 1/2	25
BS275007	3/4-10 X 3/4	20
BS275010	3/4-10 X 1	20
BS275012	3/4-10 X 1 1/4	20
BS275015	3/4-10 X 1 1/2	20
BS275017	3/4-10 X 1 3/4	20
BS275020	3/4-10 X 2	20
BS275022	3/4-10 X 2 1/4	20
BS275025	3/4-10 X 2 1/2	20
BS275027	3/4-10 X 2 3/4	20
BS275030	3/4-10 X 3	20
BS275032	3/4-10 X 3 1/4	20
BS275035	3/4-10 X 3 1/2	20
BS275040	3/4-10 X 4	20
BS275050	3/4-10 X 5	20
*****	7/8-9 X 2	20
BS287025	7/8-9 X 2 1/2	20
BS287030	7/8-9 X 3	20
BS287035	7/8-9 X 3 1/2	20
BS287040	7/8-9 X 4	20
BS290015	1-8 X 1 1/2	20
*****	1-8 X 2	20
BS290025	1-8 X 2 1/2	20

AUTRES DIMENSIONS DISPONIBLES/OTHER DIMENSIONS ARE AVAILABLE



Tel.: (819) 346-2903 / (888) 345-2903 Fax.: (819) 346-3389

Email: distributeur@boulonsestrie.com

A-85

BOULONS À TÊTE
HEXAGONALE
GROS FILETS

SS-316

HEX HEAD
CAP SCREWS
NATIONAL COARSE



ACIER INOXYDABLE

STAINLESS STEEL

NOTRE CODE	DESCRIPTION	QTÉ/BOITE
OUR CODE	DESCRIPTION	QTY/BOX
BS290030	1-8 X 3	20
BS290035	1-8 X 3 1/2	20
BS290040	1-8 X 4	20
BS290045	1-8 X 4 1/2	20

AUTRES DIMENSIONS DISPONIBLES/OTHER DIMENSIONS ARE AVAILABLE

LAITON

BRASS

NOTRE CODE	DESCRIPTION	QTÉ/BOITE
OUR CODE	DESCRIPTION	QTY/BOX
BB025005	1/4-20 X 1/2	100
BB025007	1/4-20 X 3/4	100
BB025010	1/4-20 X 1	100
BB025022	1/4-20 X 2 1/4	100
BB025025	1/4-20 X 2 1/2	100
BB025030	1/4-20 X 3	100
BB031007	5/16-18 X 3/4	100
BB031010	5/16-18 X 1	100
BB031015	5/16-18 X 1 1/2	100
BB037005	3/8-16 X 1/2	100
BB037007	3/8-16 X 3/4	100
BB037010	3/8-16 X 1	100
BB037012	3/8-16 X 1 1/4	100
BB037015	3/8-16 X 1 1/2	100
BB037020	3/8-16 X 2	100
BB037030	3/8-16 X 3	100
BB050007	1/2-13 X 3/4	50
BB050010	1/2-13 X 1	50
BB050015	1/2-13 X 1 1/2	50
BB050020	1/2-13 X 2	50
BB050025	1/2-13 X 2 1/2	50

AUTRES DIMENSIONS DISPONIBLES/OTHER DIMENSIONS ARE AVAILABLE



Tel.: (819) 346-2903 / (888) 345-2903 Fax.: (819) 346-3389

Email: distributeur@boulonsestrie.com

A-86

BOULONS À TÊTE
HEXAGONALE
GROS FILETS

GALVANISÉ
H.D.G.

HEX HEAD
CAP SCREWS
NATIONAL COARSE

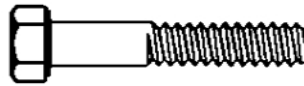

NOTRE CODE	DESCRIPTION	QTÉ/BOITE
OUR CODE	DESCRIPTION	QTY/BOX
BG125007	1/4-20 X 3/4	100
BG125010	1/4-20 X 1	100
BG125012	1/4-20 X 1 1/4	100
BG131015	5/16-18 X 1 1/2	100
BG131020	5/16-18 X 2	100
BG131022	5/16-18 X 2 1/4	100
BG131025	5/16-18 X 2 1/2	100
BG137010	3/8-16 X 1	100
BG137012	3/8-16 X 1 1/4	100
BG137015	3/8-16 X 1 1/2	100
BG137020	3/8-16 X 2	100
BG137022	3/8-16 X 2 1/4	100
BG137025	3/8-16 X 2 1/2	100
BG137035	3/8-16 X 3 1/2	100
BG137045	3/8-16 X 4 1/2	100
BG150015	1/2-13 X 1 1/2	50
BG150020	1/2-13 X 2	50
BG150025	1/2-13 X 2 1/2	50
BG150030	1/2-13 X 3	50
BG150035	1/2-13 X 3 1/2	50
BG150040	1/2-13 X 4	50
BG150065	1/2-13 X 6 1/2	50
BG150070	1/2-13 X 7	50
BG150080	1/2-13 X 8	50
BG162015	5/8-11 X 1 1/2	25
BG162017	5/8-11 X 1 3/4	25
BG162050	5/8-11 X 5	25
BG162100	5/8-11 X 10	25
BG175020	3/4-10 X 2	20
BG175035	3/4-10 X 3 1/2	20
BG175060	3/4-10 X 6	20
BG175080	3/4-10 X 8	20
BG175100	3/4-10 X 10	20
BG175140	3/4-10 X 14	20

**BOULONS À TÊTE
HEX MÉTRIQUE
CLASSE 8.8**

**DIN 931
NOIR / BARE
ZINC / PLATED**

**HEX HEAD CAP
SCREWS METRIC
CLASS 8.8**

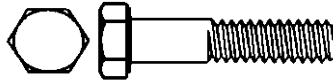

**FILETÉ EN LONGUEUR (DIN 933)
EST DISPONIBLE SUR DEMANDE**

**FULL THREADED (DIN 933) IS
AVAILABLE ON REQUEST**

NOTRE CODE NOIR	NOTRE CODE ZINC	DESCRIPTION	QTÉ/BOITE
OUR CODE BARE	OUR CODE PLATED	DESCRIPTION	QTY/BOX
BM003008	BM103008	M3 X .50 X 8	100
BM003010	BM103010	M3 X .50 X 10	100
*****	*****	M4 X .70 X 7	100
BM004008	BM104008	M4 X .70 X 8	100
BM004010	*****	M4 X .70 X 10	100
BM004012	*****	M4 X .70 X 12	100
*****	*****	M4 X .70 X 15	100
BM004016	*****	M4 X .70 X 16	100
BM004020	BM104020	M4 X .70 X 20	100
BM004025	BM104025	M4 X .70 X 25	100
BM004030	BM104030	M4 X .70 X 30	100
BM004035	BM104035	M4 X .70 X 35	100
BM004040	*****	M4 X .70 X 40	100
BM004050	*****	M4 X .70 X 50	100
BM005006	*****	M5 X .80 X 6	100
BM005008	*****	M5 X .80 X 8	100
BM005010	BM105010	M5 X .80 X 10	100
BM005012	BM105012	M5 X .80 X 12	100
BM005016	BM105016	M5 X .80 X 16	100
BM005018	*****	M5 X .80 X 18	100
BM005020	BM105020	M5 X .80 X 20	100
BM005025	*****	M5 X .80 X 25	100
BM005030	BM105030	M5 X .80 X 30	100
BM005035	*****	M5 X .80 X 35	100
BM005040	*****	M5 X .80 X 40	100

AUTRES DIMENSIONS DISPONIBLES/OTHER DIMENSIONS ARE AVAILABLE



**Tel.: (819) 346-2903 / (888) 345-2903 Fax.: (819) 346-3389
Email: distributeur@boulonsestrie.com**

A-88

BOULONS À TÊTE
HEX MÉTRIQUE
CLASSE 8.8

DIN 931
NOIR / BARE
ZINC / PLATED

HEX HEAD CAP
SCREWS METRIC
CLASS 8.8

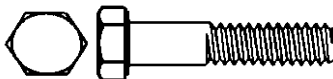

FILETÉ EN LONGUEUR (DIN 933)
EST DISPONIBLE SUR DEMANDE

FULL THREADED (DIN 933) IS
AVAILABLE ON REQUEST

NOTRE CODE NOIR	NOTRE CODE ZINC	DESCRIPTION	QTÉ/BOITE
OUR CODE BARE	OUR CODE PLATED	DESCRIPTION	QTY/BOX
BM005045	BM105045	M5 X .80 X 45	100
BM005050	BM105050	M5 X .80 X 50	100
BM005060	*****	M5 X .80 X 60	100
BM006008	BM106008	M6 X 1.00 X 8	100
BM006010	*****	M6 X 1.00 X 10	100
BM006012	BM106012	M6 X 1.00 X 12	100
BM006016	BM106016	M6 X 1.00 X 16	100
BM006018	*****	M6 X 1.00 X 18	100
BM006020	BM106020	M6 X 1.00 X 20	100
BM006025	BM106025	M6 X 1.00 X 25	100
BM006030	BM106030	M6 X 1.00 X 30	100
BM006035	BM106035	M6 X 1.00 X 35	100
BM006040	BM106040	M6 X 1.00 X 40	100
BM006045	BM106045	M6 X 1.00 X 45	100
BM006050	BM106050	M6 X 1.00 X 50	100
BM006055	BM106055	M6 X 1.00 X 55	100
BM006060	BM106060	M6 X 1.00 X 60	100
BM006065	BM106065	M6 X 1.00 X 65	100
BM006070	BM106070	M6 X 1.00 X 70	100
BM006075	*****	M6 X 1.00 X 75	100
BM006080	*****	M6 X 1.00 X 80	100
BM006090	*****	M6 X 1.00 X 90	100
BM006100	*****	M6 X 1.00 X 100	100
BM006120	*****	M6 X 1.00 X 120	100
BM007012	*****	M7 X 1.00 X 12	100

AUTRES DIMENSIONS DISPONIBLES/OTHER DIMENSIONS ARE AVAILABLE



Tel.: (819) 346-2903 / (888) 345-2903 Fax.: (819) 346-3389
Email: distributeur@boulonsestrie.com

A-89

BOULONS À TÊTE
HEX MÉTRIQUE
CLASSE 8.8

DIN 931
NOIR / BARE
ZINC / PLATED

HEX HEAD CAP
SCREWS METRIC
CLASS 8.8

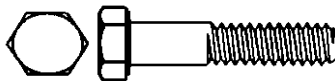

FILETÉ EN LONGUEUR (DIN 933)
EST DISPONIBLE SUR DEMANDE

FULL THREADED (DIN 933) IS
AVAILABLE ON REQUEST

NOTRE CODE NOIR	NOTRE CODE ZINC	DESCRIPTION	QTÉ/BOITE
OUR CODE BARE	OUR CODE PLATED	DESCRIPTION	QTY/BOX
BM007016	*****	M7 X 1.00 X 16	100
*****	BM107020	M7 X 1.00 X 20	100
BM007025	BM107025	M7 X 1.00 X 25	100
BM007030	*****	M7 X 1.00 X 30	100
BM007040	*****	M7 X 1.00 X 40	100
BM007045	*****	M7 X 1.00 X 45	100
BM007050	*****	M7 X 1.00 X 50	100
BM007060	*****	M7 X 1.00 X 60	100
BM007070	BM107070	M7 X 1.00 X 70	100
BM008010	*****	M8 X 1.25 X 10	100
BM008012	*****	M8 X 1.25 X 12	100
BM008016	BM108016	M8 X 1.25 X 16	100
BM008018	*****	M8 X 1.25 X 18	100
BM008020	BM108020	M8 X 1.25 X 20	100
BM008025	BM108025	M8 X 1.25 X 25	100
BM008030	BM108030	M8 X 1.25 X 30	100
BM008035	BM108035	M8 X 1.25 X 35	100
BM008040	BM108040	M8 X 1.25 X 40	100
BM008045	BM108045	M8 X 1.25 X 45	100
BM008050	BM108050	M8 X 1.25 X 50	100
BM008055	*****	M8 X 1.25 X 55	100
BM008060	BM108060	M8 X 1.25 X 60	100
BM008065	BM108065	M8 X 1.25 X 65	100
BM008070	BM108070	M8 X 1.25 X 70	100
BM008075	*****	M8 X 1.25 X 75	100

AUTRES DIMENSIONS DISPONIBLES/OTHER DIMENSIONS ARE AVAILABLE



Tel.: (819) 346-2903 / (888) 345-2903 Fax.: (819) 346-3389

Email: distributeur@boulonsestrie.com

A-90

BOULONS À TÊTE
 HEX MÉTRIQUE
 CLASSE 8.8

DIN 931
 NOIR / BARE
 ZINC / PLATED

HEX HEAD CAP
 SCREWS METRIC
 CLASS 8.8



FILETÉ EN LONGUEUR (DIN 933)
 EST DISPONIBLE SUR DEMANDE

FULL THREADED (DIN 933) IS
 AVAILABLE ON REQUEST

NOTRE CODE NOIR	NOTRE CODE ZINC	DESCRIPTION	QTÉ/BOITE
OUR CODE BARE	OUR CODE PLATED	DESCRIPTION	QTY/BOX
BM008080	BM108080	M8 X 1.25 X 80	100
BM008090	BM108090	M8 X 1.25 X 90	100
BM008100	*****	M8 X 1.25 X 100	50
BM008120	*****	M8 X 1.25 X 120	50
BM008150	*****	M8 X 1.25 X 150	50
BM010012	BM110012	M10 X 1.50 X 12	100
BM010016	BM110016	M10 X 1.50 X 16	100
BM010018	*****	M10 X 1.50 X 18	100
BM010020	BM110020	M10 X 1.50 X 20	100
BM010025	BM110025	M10 X 1.50 X 25	100
BM010030	BM110030	M10 X 1.50 X 30	100
BM010035	BM111035	M10 X 1.50 X 35	100
BM010040	BM110040	M10 X 1.50 X 40	100
BM010045	BM110045	M10 X 1.50 X 45	100
BM010050	BM110050	M10 X 1.50 X 50	100
BM010055	*****	M10 X 1.50 X 55	100
BM010060	BM110060	M10 X 1.50 X 60	100
BM010065	BM110065	M10 X 1.50 X 65	100
BM010070	BM110070	M10 X 1.50 X 70	100
BM010080	*****	M10 X 1.50 X 80	100
BM010090	*****	M10 X 1.50 X 90	100
BM010095	*****	M10 X 1.50 X 95	100
BM010100	BM110100	M10 X 1.50 X 100	50
BM010130	*****	M10 X 1.50 X 130	50
BM010150	*****	M10 X 1.50 X 150	50
BM012016	*****	M12 X 1.75 X 16	100

AUTRES DIMENSIONS DISPONIBLES/OTHER DIMENSIONS ARE AVAILABLE



Tel.: (819) 346-2903 / (888) 345-2903 Fax.: (819) 346-3389
 Email: distributeur@boulonsestrie.com

BOULONS À TÊTE
 HEX MÉTRIQUE
 CLASSE 8.8

DIN 931
 NOIR / BARE
 ZINC / PLATED

HEX HEAD CAP
 SCREWS METRIC
 CLASS 8.8



FILETÉ EN LONGUEUR (DIN 933)
 EST DISPONIBLE SUR DEMANDE

FULL THREADED (DIN 933) IS
 AVAILABLE ON REQUEST

NOTRE CODE NOIR	NOTRE CODE ZINC	DESCRIPTION	QTÉ/BOITE
OUR CODE BARE	OUR CODE PLATED	DESCRIPTION	QTY/BOX
BM012020	BM112020	M12 X 1.75 X 20	100
BM012025	BM112025	M12 X 1.75 X 25	100
BM012030	BM112030	M12 X 1.75 X 30	100
BM012035	BM112035	M12 X 1.75 X 35	100
BM012040	BM112040	M12 X 1.75 X 40	100
BM012045	BM112045	M12 X 1.75 X 45	100
BM012050	BM112050	M12 X 1.75 X 50	100
BM012055	*****	M12 X 1.75 X 55	100
BM012060	BM112060	M12 X 1.75 X 60	100
BM012065	BM112065	M12 X 1.75 X 65	50
BM012070	BM112070	M12 X 1.75 X 70	50
BM012075	BM112075	M12 X 1.75 X 75	50
BM012080	BM112080	M12 X 1.75 X 80	50
BM012085	*****	M12 X 1.75 X 85	50
BM012090	*****	M12 X 1.75 X 90	50
BM012100	BM112100	M12 X 1.75 X 100	25
BM012110	BM112110	M12 X 1.75 X 110	25
BM012130	BM112130	M12 X 1.75 X 130	25
BM012150	BM112150	M12 X 1.75 X 150	25
BM012160	*****	M12 X 1.75 X 160	25
BM014020	*****	M14 X 2.00 X 20	50
BM014025	*****	M14 X 2.00 X 25	50
BM014030	*****	M14 X 2.00 X 30	50
BM014035	BM114035	M14 X 2.00 X 35	50
BM014040	*****	M14 X 2.00 X 40	50

AUTRES DIMENSIONS DISPONIBLES/OTHER DIMENSIONS ARE AVAILABLE



Tel.: (819) 346-2903 / (888) 345-2903 Fax.: (819) 346-3389
 Email: distributeur@boulonsestrie.com

BOULONS À TÊTE
HEX MÉTRIQUE
CLASSE 8.8

DIN 931
NOIR / BARE
ZINC / PLATED

HEX HEAD CAP
SCREWS METRIC
CLASS 8.8

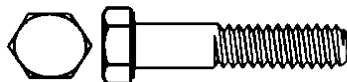

FILETÉ EN LONGUEUR (DIN 933)
EST DISPONIBLE SUR DEMANDE

FULL THREADED (DIN 933) IS
AVAILABLE ON REQUEST

NOTRE CODE NOIR	NOTRE CODE ZINC	DESCRIPTION	QTÉ/BOITE
OUR CODE BARE	OUR CODE PLATED	DESCRIPTION	QTY/BOX
*****	BM114045	M14 X 2.00 X 45	50
BM014050	*****	M14 X 2.00 X 50	50
BM014060	BM114060	M14 X 2.00 X 60	50
BM014065	*****	M14 X 2.00 X 65	50
BM014070	BM114070	M14 X 2.00 X 70	50
BM014075	*****	M14 X 2.00 X 75	50
BM014080	BM114080	M14 X 2.00 X 80	50
BM014090	BM114090	M14 X 2.00 X 90	50
BM014100	*****	M14 X 2.00 X 100	25
BM014130	*****	M14 X 2.00 X 130	25
BM014150	*****	M14 X 2.00 X 150	25
BM016020	*****	M16 X 2.00 X 20	50
BM016025	BM116025	M16 X 2.00 X 25	50
BM016030	BM116030	M16 X 2.00 X 30	50
BM016035	BM116035	M16 X 2.00 X 35	50
BM016040	BM116040	M16 X 2.00 X 40	50
BM016045	BM116045	M16 X 2.00 X 45	50
BM016050	BM116050	M16 X 2.00 X 50	50
BM016055	*****	M16 X 2.00 X 55	25
BM016060	BM116060	M16 X 2.00 X 60	25
BM016065	BM116065	M16 X 2.00 X 65	25
BM016070	BM116070	M16 X 2.00 X 70	25
BM016075	BM116075	M16 X 2.00 X 75	25
BM016080	*****	M16 X 2.00 X 80	25
BM016085	*****	M16 X 2.00 X 85	25

AUTRES DIMENSIONS DISPONIBLES/OTHER DIMENSIONS ARE AVAILABLE



Tel.: (819) 346-2903 / (888) 345-2903 Fax.: (819) 346-3389
Email: distributeur@boulonsestrie.com

A-93

BOULONS À TÊTE
HEX MÉTRIQUE
CLASSE 8.8

DIN 931
NOIR / BARE
ZINC / PLATED

HEX HEAD CAP
SCREWS METRIC
CLASS 8.8

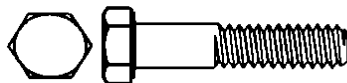

FILETÉ EN LONGUEUR (DIN 933)
EST DISPONIBLE SUR DEMANDE

FULL THREADED (DIN 933) IS
AVAILABLE ON REQUEST

NOTRE CODE NOIR	NOTRE CODE ZINC	DESCRIPTION	QTÉ/BOITE
OUR CODE BARE	OUR CODE PLATED	DESCRIPTION	QTY/BOX
BM016090	BM116090	M16 X 2.00 X 90	25
BM016100	BM116100	M16 X 2.00 X 100	25
BM016110	*****	M16 X 2.00X 110	25
BM016130	BM116130	M16 X 2.00 X 130	25
BM016140	*****	M16 X 2.00 X 140	25
BM016150	BM116150	M16 X 2.00X 150	25
BM016160	*****	M16 X 2.00 X 160	25
BM016200	*****	M16 X 2.00 X 200	25
BM018035	*****	M18 X 2.50 X 35	25
BM018040	*****	M18 X 2.50 X 40	25
BM018050	*****	M18 X 2.50 X 50	25
BM018060	*****	M18 X 2.50 X 60	25
BM018070	*****	M18 X 2.50 X 70	25
BM018080	*****	M18 X 2.50 X 80	25
BM018090	*****	M18 X 2.50 X 90	25
BM018100	*****	M18 X 2.50 X 100	25
BM020030	*****	M20 X 2.50 X 30	10
BM020035	*****	M20 X 2.50 X 35	10
BM020040	BM120040	M20 X 2.50 X 40	10
BM020045	*****	M20 X 2.50 X 45	10
BM020050	BM120050	M20 X 2.50 X 50	10
BM020055	*****	M20 X 2.50 X 55	10
BM020060	BM120060	M20 X 2.50 X 60	10
BM020065	BM120065	M20 X 2.50 X 65	10

AUTRES DIMENSIONS DISPONIBLES/OTHER DIMENSIONS ARE AVAILABLE



Tel.: (819) 346-2903 / (888) 345-2903 Fax.: (819) 346-3389
Email: distributeur@boulonsestrie.com

BOULONS À TÊTE
 HEX MÉTRIQUE
 CLASSE 8.8

DIN 931
 NOIR / BARE
 ZINC / PLATED

HEX HEAD CAP
 SCREWS METRIC
 CLASS 8.8

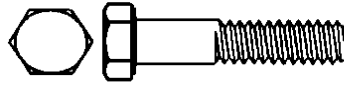

FILETÉ EN LONGUEUR (DIN 933)
 EST DISPONIBLE SUR DEMANDE

FULL THREADED (DIN 933) IS
 AVAILABLE ON REQUEST

NOTRE CODE NOIR	NOTRE CODE ZINC	DESCRIPTION	QTÉ/BOITE
OUR CODE BARE	OUR CODE PLATED	DESCRIPTION	QTY/BOX
BM020070	BM120070	M20 X 2.50 X 70	10
BM020075	BM120075	M20 X 2.50 X 75	10
BM020080	BM120080	M20 X 2.50 X 80	10
BM020090	BM120090	M20 X 2.50 X 90	10
BM020100	BM120100	M20 X 2.50 X 100	10
BM020110	BM120130	M20 X 2.50 X 110	10
BM024050	*****	M24 X 3.00 X 50	10
BM024055	*****	M24 X 3.00 X 55	10
BM024060	*****	M24 X 3.00 X 60	10
BM024065	*****	M24 X 3.00 X 65	10
BM024070	*****	M24 X 3.00 X 70	10
BM024075	BM124075	M24 X 3.00 X 75	10
*****	BM124080	M24 X 3.00 X 80	10
BM024090	*****	M24 X 3.00 X 90	10
BM024100	*****	M24 X 3.00 X 100	10
BM024110	*****	M24 X 3.00 X 110	10
BM024120	BM124120	M24 X 3.00 X 120	10
BM024130	*****	M24 X 3.00 X 130	10
BM024140	*****	M24 X 3.00 X 140	10
BM024150	*****	M24 X 3.00 X 150	10
BM024160	*****	M24 X 3.00 X 160	10
BM024180	*****	M24 X 3.00X 180	10
BM024200	*****	M24 X 3.00X 200	10

AUTRES DIMENSIONS DISPONIBLES/OTHER DIMENSIONS ARE AVAILABLE



Tel.: (819) 346-2903 / (888) 345-2903 Fax.: (819) 346-3389
 Email: distributeur@boulonsestrie.com

BOULONS À TÊTE
HEXAGONALE
ACIER INOXYDABLE
MÉTRIQUE DIN 931

SS-304
A-2

HEX HEAD
CAP SCREWS
STAINLESS STEEL
METRIC DIN 931

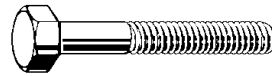

NOTRE CODE	DESCRIPTION
OUR CODE	DESCRIPTION
BS304006	M4 X .70 X 6
BS304010	M4 X .70 X 10
BS304012	M4 X .70 X 12
BS304030	M4 X .70 X 30
BS304040	M4 X .70 X 40
BS305005	M5 X .80 X 5
BS305008	M5 X .80 X 8
BS305010	M5 X .80 X 10
BS305012	M5 X .80 X 12
BS305015	M5 X .80 X 15
BS305016	M5 X .80 X 16
BS305030	M5 X .80 X 30
BS305040	M5 X .80 X 40
BS305045	M5 X .80 X 45
BS306010	M6 X 1.00 X 10
BS306012	M6 X 1.00 X 12
BS306016	M6 X 1.00 X 16
BS306018	M6 X 1.00 X 18
BS306020	M6 X 1.00 X 20
BS306025	M6 X 1.00 X 25
BS306030	M6 X 1.00 X 30
BS306035	M6 X 1.00 X 35
BS306040	M6 X 1.00 X 40
BS306045	M6 X 1.00 X 45
BS306050	M6 X 1.00 X 50
BS306060	M6 X 1.00 X 60
BS308015	M8 X 1.25 X 15
BS308016	M8 X 1.25 X 16
BS308020	M8 X 1.25 X 20
BS308025	M8 X 1.25 X 25

NOTRE CODE	DESCRIPTION
OUR CODE	DESCRIPTION
BS308030	M8 X 1.25 X 30
BS308035	M8 X 1.25 X 35
BS308040	M8 X 1.25 X 40
BS308045	M8 X 1.25 X 45
BS308050	M8 X 1.25 X 50
BS308055	M8 X 1.25 X 55
BS308060	M8 X 1.25 X 60
BS310020	M10 X 1.50 X 20
BS310025	M10 X 1.50 X 25
BS310030	M10 X 1.50 X 30
BS310035	M10 X 1.50 X 35
BS310040	M10 X 1.50 X 40
BS310045	M10 X 1.50 X 45
BS310050	M10 X 1.50 X 50
BS310060	M10 X 1.50 X 60
BS310070	M10 X 1.50 X 70
BS310080	M10 X 1.50 X 80
BS310090	M10 X 1.50 X 90
BS312030	M12 X 1.75 X 30
BS312040	M12 X 1.75 X 40
BS312045	M12 X 1.75 X 45
BS312050	M12 X 1.75 X 50
BS312080	M12 X 1.75 X 80
BS312090	M12 X 1.75 X 90
BS316050	M16 X 2.00 X 50
BS316220	M16 X 2.00 X 220

Ces items sont vendus à l'unité

SS316 / A4:
DISPONIBLE SUR DEMANDE
AVAILABLE ON REQUEST

AUTRES DIMENSIONS DISPONIBLES / OTHER DIMENSIONS ARE AVAILABLE



Tel.: (819) 346-2903 / (888) 345-2903 Fax.: (819) 346-3389

Email: distributeur@boulonstrie.com

A-96

BOULONS À COLLERETTE
GRADE 5

ZINC / PLATED

FLANGE BOLTS
GRADE 5

MÉTRIQUE DISPONIBLE
SUR DEMANDE



METRIC AVAILABLE
ON REQUEST

NOTRE CODE	DESCRIPTION	NOTRE CODE	DESCRIPTION	NOTRE CODE	DESCRIPTION																		
OUR CODE	DESCRIPTION	OUR CODE	DESCRIPTION	OUR CODE	DESCRIPTION																		
*****	6-32 X 1/4	BF025005	1/4-20 X 1/2	BF037012	3/8-16 X 1 1/4																		
*****	6-32 X 5/16	BF025006	1/4-20 X 5/8	BF037015	3/8-16 X 1 1/2																		
*****	6-32 X 3/8	BF025007	1/4-20 X 3/4	BF037020	3/8-16 X 2																		
*****	6-32 X 1/2	BF025008	1/4-20 X 7/8	*****	3/8-16 X 2 1/4																		
*****	6-32 X 5/8	*****	1/4-20 X 1	BF037025	3/8-16 X 2 1/2																		
*****	6-32 X 3/4	BF025012	1/4-20 X 1 1/4	*****	3/8-16 X 3																		
*****	6-32 X 7/8	BF025015	1/4-20 X 1 1/2	BF037035	3/8-16 X 3 1/2																		
*****	6-32 X 1	*****	1/4-20 X 1 3/4	BF037040	3/8-16 X 4																		
*****	8-32 X 1/4	BF025020	1/4-20 X 2	*****	1/2-13 X 3/4																		
*****	8-32 X 3/8	*****	1/4-20 X 2 1/4	BF050010	1/2-13 X 1																		
*****	8-32 X 1/2	*****	1/4-20 X 2 1/2	*****	1/2-13 X 1 1/4																		
*****	8-32 X 5/8	BF025030	1/4-20 X 3	*****	1/2-13 X 1 1/2																		
*****	8-32 X 3/4	*****	1/4-20 X 3 1/2	*****	1/2-13 X 1 3/4																		
*****	8-32 X 7/8	*****	1/4-20 X 4	*****	1/2-13 X 2																		
*****	8-32 X 1	*****	5/16-18 X 1/2	*****	1/2-13 X 2 1/4																		
*****	10-24 X 3/8	BF031006	5/16-18 X 5/8	BF050025	1/2-13 X 2 1/2																		
BF010005	10-24 X 1/2	BF031007	5/16-18 X 3/4	<p align="center">Format des boîtes Quantity per box</p> <table border="1"> <thead> <tr> <th>Description</th> <th>Qté.</th> </tr> </thead> <tbody> <tr> <td>6-32</td> <td>100</td> </tr> <tr> <td>8-32</td> <td>100</td> </tr> <tr> <td>10-24</td> <td>100</td> </tr> <tr> <td>10-32</td> <td>100</td> </tr> <tr> <td>1/4-20</td> <td>100</td> </tr> <tr> <td>5/16-18</td> <td>100</td> </tr> <tr> <td>3/8-16</td> <td>100</td> </tr> <tr> <td>1/2-13</td> <td>50</td> </tr> </tbody> </table>		Description	Qté.	6-32	100	8-32	100	10-24	100	10-32	100	1/4-20	100	5/16-18	100	3/8-16	100	1/2-13	50
Description	Qté.																						
6-32	100																						
8-32	100																						
10-24	100																						
10-32	100																						
1/4-20	100																						
5/16-18	100																						
3/8-16	100																						
1/2-13	50																						
*****	10-24 X 5/8	BF031010	5/16-18 X 1																				
BF010007	10-24 X 3/4	BF031012	5/16-18 X 1 1/4																				
*****	10-24 X 1	BF031015	5/16-18 X 1 1/2																				
BF010012	10-24 X 1 1/4	*****	5/16-18 X 1 3/4																				
*****	10-32 X 5/16	*****	5/16-18 X 2																				
*****	10-32 X 3/8	*****	5/16-18 X 2 1/4																				
*****	10-32 X 1/2	*****	5/16-18 X 2 1/2																				
*****	10-32 X 5/8	BF037005	3/8-16 X 1/2																				
*****	10-32 X 3/4	*****	3/8-16 X 5/8																				
*****	10-32 X 1	BF037007	3/8-16 X 3/4																				
*****	1/4-20 X 3/8	BF037010	3/8-16 X 1																				

AUTRES DIMENSIONS DISPONIBLES/OTHER DIMENSIONS ARE AVAILABLE



Tel.: (819) 346-2903 / (888) 345-2903 Fax.: (819) 346-3389

Email: distributeur@boulonstrie.com

**LE NOIR EST
DISPONIBLE
SUR DEMANDE**

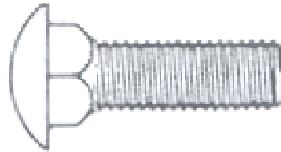

**BARE IS AVAILABLE
ON REQUEST**

SS-304 & 316 DISP. SUR DEMANDE / SS-304 & 316 IS AVAILABLE ON REQUEST

NOTRE CODE ZINC	DESCRIPTION	QTÉ/BOÎTE	QTÉ/VRAC
OUR CODE PLATED	DESCRIPTION	QTY/BOX	QTY/BULK
CA225005	1/4-20 X 1/2	100	2800
CA225007	1/4-20 X 3/4	100	2400
CA225010	1/4-20 X 1	100	2000
CA225012	1/4-20 X 1 1/4	100	1600
CA225015	1/4-20 X 1 1/2	100	1300
CA225017	1/4-20 X 1 3/4	100	1100
CA225020	1/4-20 X 2	100	900
CA225022	1/4-20 X 2 1/4	100	800
CA225025	1/4-20 X 2 1/2	100	700
CA225027	1/4-20 X 2 3/4	100	650
CA225030	1/4-20 X 3	100	600
CA225032	1/4-20 X 3 1/4	100	550
CA225035	1/4-20 X 3 1/2	100	550
CA225040	1/4-20 X 4	100	450
CA225045	1/4-20 X 4 1/2	100	350
CA225050	1/4-20 X5	100	350
CA225055	1/4-20 X 5 1/2	100	300
CA225060	1/4-20 X 6	100	300
CA225065	1/4-20 X6 1/2	100	300
CA225070	1/4-20 X 7	100	275
CA225075	1/4-20 X 7 1/2	100	325
CA225080	1/4-20 X 8	100	300
CA231007	5/16-18 X 3/4	100	1400
CA231010	5/16-18 X 1	100	1100
CA231012	5/16-18 X 1 1/4	100	950
CA231015	5/16-18 X 1 1/2	100	800
CA231017	5/16-18 X 1 3/4	100	700

AUTRES DIMENSIONS DISPONIBLES/OTHER DIMENSIONS ARE AVAILABLE

**BOULONS DE
CARROSSERIE
GRADE 2**

ZINC / PLATED

**CARRIAGE BOLTS
GRADE 2**

**LE NOIR EST
DISPONIBLE
SUR DEMANDE**

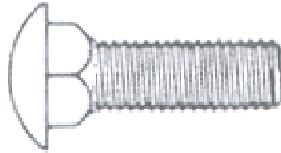

**BARE IS AVAILABLE
ON REQUEST**

SS-304 & 316 DISP. SUR DEMANDE / SS-304 & 316 IS AVAILABLE ON REQUEST

NOTRE CODE ZINC	DESCRIPTION	QTÉ/BOÎTE	QTÉ/VRAC
OUR CODE PLATED	DESCRIPTION	QTY/BOX	QTY/BULK
CA231020	5/16-18 X 2	100	700
CA231022	5/16-18 X 2 1/4	100	550
CA231025	5/16-18 X 2 1/2	100	450
CA231027	5/16-18 X 2 3/4	100	400
CA231030	5/16-18 X 3	100	400
CA231035	5/16-18 X 3 1/2	100	300
CA231040	5/16-18 X 4	100	275
CA231045	5/16-18 X 4 1/2	100	250
CA231050	5/16-18 X 5	100	200
CA231055	5/16-18 X 5 1/2	100	200
CA231060	5/16-18 X 6	100	200
CA231065	5/16-18 X 6 1/2	100	200
CA231070	5/16-18 X 7	100	200
CA231075	5/16-18 X 7 1/2	100	225
CA231080	5/16-18 X 8	100	200
CA231100	5/16-18 X 10	100	150
CA237007	3/8-16 X 3/4	100	900
CA237010	3/8-16 X 1	100	750
CA237012	3/8-16 X 1 1/4	100	600
CA237015	3/8-16 X 1 1/2	100	550
CA237017	3/8-16 X 1 3/4	100	500
CA237020	3/8-16 X 2	100	450
CA237022	3/8-16 X 2 1/4	100	400
CA237025	3/8-16 X 2 1/2	100	350
CA237027	3/8-16 X 2 3/4	100	325
CA237030	3/8-16 X 3	100	300
CA237035	3/8-16 X 3 1/2	100	250

AUTRES DIMENSIONS DISPONIBLES/OTHER DIMENSIONS ARE AVAILABLE

**LE NOIR EST
DISPONIBLE
SUR DEMANDE**

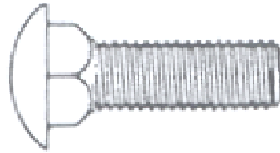

**BARE IS AVAILABLE
ON REQUEST**

SS-304 & 316 DISP. SUR DEMANDE / SS-304 & 316 IS AVAILABLE ON REQUEST

NOTRE CODE ZINC	DESCRIPTION	QTÉ/BOÎTE	QTÉ/VRAC
OUR CODE PLATED	DESCRIPTION	QTY/BOX	QTY/BULK
CA237040	3/8-16 X 4	100	225
CA237045	3/8-16 X 4 1/2	50	175
CA237050	3/8-16 X 5	50	175
CA237055	3/8-16 X 5 1/2	50	175
CA237060	3/8-16 X 6	50	150
CA237065	3/8-16 X 6 1/2	50	150
CA237070	3/8-16 X 7	50	150
CA237075	3/8-16 X 7 1/2	50	125
CA237080	3/8-16 X 8	50	125
CA237085	3/8-16 X 8 1/2	50	120
CA237090	3/8-16 X 9	50	120
CA237095	3/8-16 X 9 1/2	50	115
CA237100	3/8-16 X 10	50	110
CA237110	3/8-16 X 11	50	100
CA237120	3/8-16 X 12	50	90
CA243010	7/16-14 X 1	50	550
CA243015	7/16-14 X 1 1/2	50	400
CA243017	7/16-14 X 1 3/4	50	350
CA243025	7/16-14 X 2 1/2	50	275
CA243030	7/16-14 X 3	50	225
CA243035	7/16-14 X 3 1/2	50	200
CA243037	7/16-14 X 3 3/4	50	200
CA243040	7/16-14 X 4	50	175
CA243050	7/16-14 X 5	50	125
CA243055	7/16-14 X 5 1/2	50	125
CA243060	7/16-14 X 6	50	110

AUTRES DIMENSIONS DISPONIBLES/OTHER DIMENSIONS ARE AVAILABLE



Tel.: (819) 346-2903 / (888) 345-2903 Fax.: (819) 346-3389

Email: distributeur@boulonestrie.com

A-100

**LE NOIR EST
DISPONIBLE
SUR DEMANDE**

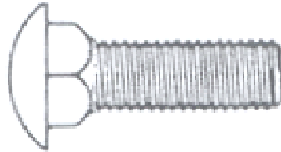

**BARE IS AVAILABLE
ON REQUEST**

SS-304 & 316 DISP. SUR DEMANDE / SS-304 & 316 IS AVAILABLE ON REQUEST

NOTRE CODE ZINC	DESCRIPTION	QTÉ/BOÎTE	QTÉ/VRAC
OUR CODE PLATED	DESCRIPTION	QTY/BOX	QTY/BULK
CA250010	1/2-13 X 1	50	375
CA250012	1/2-13 X 1 1/4	50	375
CA250015	1/2-13 X 1 1/2	50	325
CA250017	1/2-13 X 1 3/4	50	300
CA250020	1/2-13 X 2	50	250
CA250022	1/2-13 X 2 1/4	50	225
CA250025	1/2-13 X 2 1/2	50	200
CA250027	1/2-13 X 2 3/4	50	200
CA250030	1/2-13 X 3	50	150
CA250035	1/2-13 X 3 1/2	50	125
CA250037	1/2-13 X 3 3/4	50	125
CA250040	1/2-13 X 4	50	125
CA250045	1/2-13 X 4 1/2	50	110
CA250050	1/2-13 X 5	50	100
CA250055	1/2-13 X 5 1/2	50	100
CA250060	1/2-13 X 6	50	90
CA250065	1/2-13 X 6 1/2	50	85
CA250070	1/2-13 X 7	50	75
CA250080	1/2-13 X 8	50	80
CA250085	1/2-13 X 8 1/2	25	75
CA250095	1/2-13 X 9 1/2	25	70
CA250100	1/2-13 X 10	25	65
CA250110	1/2-13 X 11	25	60
CA250120	1/2-13 X 12	25	55

AUTRES DIMENSIONS DISPONIBLES/OTHER DIMENSIONS ARE AVAILABLE



LE NOIR EST
DISPONIBLE
SUR DEMANDE



BARE IS AVAILABLE
ON REQUEST

NOTRE CODE ZINC	DESCRIPTION	QTÉ/BOITE	QTÉ/VRAC
OUR CODE PLATED	DESCRIPTION	QTY/BOX	QTY/BULK
LS225010	1/4 X 1	100	2600
LS225012	1/4 X 1 1/4	100	2200
LS225015	1/4 X 1 1/2	100	1700
LS225017	1/4 X 1 3/4	100	1600
LS225020	1/4 X 2	100	1300
LS225025	1/4 X 2 1/2	100	950
LS225030	1/4 X 3	100	700
LS225035	1/4 X 3 1/2	100	600
LS225040	1/4 X 4	100	450
LS225045	1/4 X 4 1/2	100	400
LS225050	1/4 X 5	100	400
LS225055	1/4 X 5 1/2	100	400
LS225060	1/4 X 6	100	400
LS231007	5/16 X 3/4	100	-
LS231010	5/16 X 1	100	1400
LS231012	5/16 X 1 1/4	100	1200
LS231015	5/16 X 1 1/2	100	1000
LS231017	5/16 X 1 3/4	100	950
LS231020	5/16 X 2	100	850
LS231025	5/16 X 2 1/2	100	650
LS231030	5/16 X 3	100	500
LS231035	5/16 X 3 1/2	100	400
LS231040	5/16 X 4	100	300
LS231045	5/16 X 4 1/2	100	300
LS231050	5/16 X 5	100	275
LS231055	5/16 X 5 1/2	100	275
LS231060	5/16 X 6	100	275
LS237015	3/8 X 1 1/2	100	750
LS237017	3/8 X 1 3/4	100	650

AUTRES DIMENSIONS DISPONIBLES/OTHER DIMENSIONS ARE AVAILABLE



Tel.: (819) 346-2903 / (888) 345-2903 Fax.: (819) 346-3389

Email: distributeur@boulonstrie.com

LE NOIR EST
DISPONIBLE
SUR DEMANDE



BARE IS AVAILABLE
ON REQUEST

NOTRE CODE ZINC	DESCRIPTION	QTÉ/BOITE	QTÉ/VRAC
OUR CODE PLATED	DESCRIPTION	QTY/BOX	QTY/BULK
LS237020	3/8 X 2	100	600
LS237025	3/8 X 2 1/2	100	500
LS237030	3/8 X 3	100	400
LS237035	3/8 X 3 1/2	100	325
LS237040	3/8 X 4	100	275
LS237045	3/8 X 4 1/2	100	250
LS237050	3/8 X 5	100	225
LS237055	3/8 X 5 1/2	100	225
LS237060	3/8 X 6	100	200
LS237070	3/8 X 7	100	175
LS237080	3/8 X 8	100	150
LS237090	3/8 X 9	100	130
LS237100	3/8 X 10	50	120
LS237120	3/8 X 12	50	100
LS250020	1/2 X 2	50	300
LS250025	1/2 X 2 1/2	50	250
LS250030	1/2 X 3	50	200
LS250035	1/2 X 3 1/2	50	175
LS250040	1/2 X 4	50	150
LS250045	1/2 X 4 1/2	50	130
LS250050	1/2 X 5	50	125
LS250055	1/2 X 5 1/2	50	125
LS250060	1/2 X 6	50	100
LS250070	1/2 X 7	50	100
LS250080	1/2 X 8	50	90
LS250090	1/2 X 9	25	75
LS250100	1/2 X 10	25	65
LS250110	1/2 X 11	25	-
LS250120	1/2 X 12	25	55

AUTRES DIMENSIONS DISPONIBLES/OTHER DIMENSIONS ARE AVAILABLE



Tel.: (819) 346-2903 / (888) 345-2903 Fax.: (819) 346-3389

Email: distributeur@boulonstrie.com

LE NOIR EST
DISPONIBLE
SUR DEMANDE



BARE IS AVAILABLE
ON REQUEST

NOTRE CODE ZINC	DESCRIPTION	QTÉ/BOITE	QTÉ/VRAC
OUR CODE PLATED	DESCRIPTION	QTY/BOX	QTY/BULK
LS262025	5/8 X 2 1/2	25	150
LS262040	5/8 X 4	25	100
LS262060	5/8 X 6	25	65
LS262070	5/8 X 7	25	65
LS262080	5/8 X 8	25	60
LS262090	5/8 X 9	25	50

AUTRES DIMENSIONS DISPONIBLES/OTHER DIMENSIONS ARE AVAILABLE

AUSSI DISPONIBLE / ALSO AVAILABLE

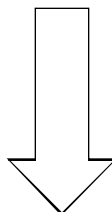

ACIER INOXYDABLE 304 & 316 / STAINLESS STEEL 304 & 316

GALVANISÉ À CHAUD / HOT DIP GALVANIZED



Tel.: (819) 346-2903 / (888) 345-2903 Fax.: (819) 346-3389

Email: distributeur@boulonsestrie.com

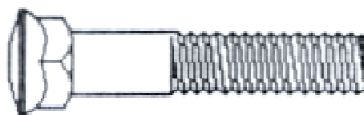

NOTRE CODE	DESCRIPTION	QTÉ/BOITE	QTÉ/VRAC
OUR CODE	DESCRIPTION	QTY/BOX	QTY/BULK
SC562020	5/8 X 2	25	200
SC562022	5/8 X 2 1/4	25	175
SC562025	5/8 X 2 1/2	25	175
SC562027	5/8 X 2 3/4	25	*****
SC562030	5/8 X 3	25	150
SC562035	5/8 X 3 1/2	25	125
SC562040	5/8 X 4	25	*****
SC562045	5/8 X 4 1/2	25	*****
SC575020	3/4 X 2	20	150
SC575022	3/4 X 2 1/4	20	125
SC575025	3/4 X 2 1/2	20	125
SC575027	3/4 X 2 3/4	20	100
SC575030	3/4 X 3	20	100
SC575035	3/4 X 3 1/2	20	90
SC575040	3/4 X 4	20	*****
SC575045	3/4 X 4 1/2	20	*****
SC575050	3/4 X 5	20	*****
SC587025	7/8 X 2 1/2	20	*****
SC587027	7/8 X 2 3/4	20	75
SC587030	7/8 X 3	20	70
*****	7/8 X 3 1/2	20	60
SC587040	7/8 X 4	20	*****
SC587045	7/8 X 4 1/2	20	*****
SC587060	7/8 X 6	20	*****
SC590030	1 X 3	20	60
SC590032	1 X 3 1/4	20	50
SC590035	1 X 3 1/2	20	45
SC590040	1 X 4	20	40

AUTRES DIMENSIONS DISPONIBLES/ OTHER DIMENSIONS ARE AVAILABL



Tel.: (819) 346-2903 / (888) 345-2903 Fax.: (819) 346-3389

Email: distributeur@boulonsestrie.com

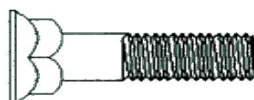

NOTRE CODE	DESCRIPTION	QTÉ/BOITE	QTÉ/VRAC
OUR CODE	DESCRIPTION	QTY/BOX	QTY/BULK
PB037010	3/8 X 1	100	1200
PB037012	3/8 X 1 1/4	100	1000
PB037015	3/8 X 1 1/2	100	850
PB037017	3/8 X 1 3/4	100	725
PB037020	3/8 X 2	100	625
PB037025	3/8 X 2 1/2	100	500
PB037030	3/8 X 3	100	*****
PB043010	7/16 X 1	50	850
PB043012	7/16 X 1 1/4	50	700
PB043017	7/16 X 1 3/4	50	525
PB043020	7/16 X 2	50	475
PB043025	7/16 X 2 1/2	50	350
*****	7/16 X 3	50	300
PB050010	1/2 X 1	50	*****
PB050012	1/2 X 1 1/4	50	525
PB050015	1/2 X 1 1/2	50	450
PB050017	1/2 X 1 3/4	50	400
PB050020	1/2 X 2	50	350
PB050022	1/2 X 2 1/4	50	300
PB050025	1/2 X 2 1/2	50	275
PB050027	1/2 X 2 3/4	50	250
PB050030	1/2 X 3	50	225
PB050035	1/2 X 3 1/2	50	200
PB050040	1/2 X 4	50	175
SC562015	5/8 X 1 1/2	25	275
SC562017	5/8 X 1 3/4	25	250
SC562020	5/8 X 2	25	225
SC562022	5/8 X 2 1/4	25	200

AUTRES DIMENSIONS DISPONIBLES/ OTHER DIMENSIONS ARE AVAILABLE



Tel.: (819) 346-2903 / (888) 345-2903 Fax.: (819) 346-3389

Email: distributeur@boulonsestrie.com

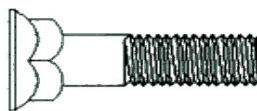

NOTRE CODE	DESCRIPTION	QTÉ/BOITE	QTÉ/VRAC
OUR CODE	DESCRIPTION	QTY/BOX	QTY/BULK
SC562025	5/8 X 2 1/2	25	175
SC562027	5/8 X 2 3/4	25	*****
SC562030	5/8 X 3	25	150
SC562035	5/8 X 3 1/2	25	125
SC562040	5/8 X 4	25	*****
SC562045	5/8 X 4 1/2	25	*****
SC575025	3/4 X 2 1/2	20	125
SC575030	3/4 X 3	20	100
SC575035	3/4 X 3 1/2	20	90

AUTRES DIMENSIONS DISPONIBLES/ OTHER DIMENSIONS ARE AVAILABLE

AUSSI DISPONIBLE

ALSO AVAILABLE

GRADE 8



Tel.: (819) 346-2903 / (888) 345-2903 Fax.: (819) 346-3389

Email: distributeur@boulonsestrie.com

ZINC DISPONIBLE SUR
DEMANDE

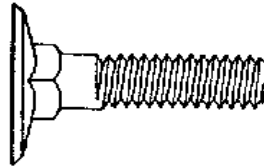

PLATED ARE AVAILABLE
ON REQUEST

NOTRE CODE	DESCRIPTION	QTÉ/BOITE
OUR CODE	DESCRIPTION	QTY/BOX
BE025007	1/4 X 3/4	100
BE025010	1/4 X 1	100
BE025012	1/4 X 1 1/4	100
BE025015	1/4 X 1 1/2	100
BE025020	1/4 X 2	100
BE031010	5/16 X 1	100
BE031012	5/16 X 1 1/4	100
BE031015	5/16 X 1 1/2	100
BE031020	5/16 X 2	100
BE037015	3/8 X 1 1/2	100
BE037020	3/8 X 2	100
BE037030	3/8 X 3	100

AUTRES DIMENSIONS DISPONIBLES / OTHER DIMENSIONS ARE AVAILABLE

AUSSI DISPONIBLE / ALSO AVAILABLE

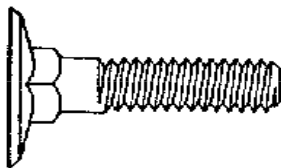

ACIER INOXYDABLE 304 /
STAINLESS STEEL 304

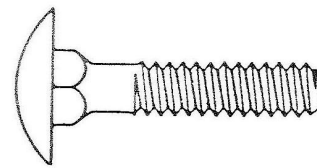

BOULONS D'ÉCHELLE /
STEP BOLTS

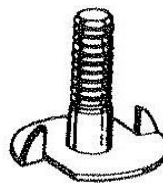

FANGED



Tel.: (819) 346-2903 / (888) 345-2903 Fax.: (819) 346-3389

Email: distributeur@boulonsestrie.com

ACIER FORGÉ AU CARBONE

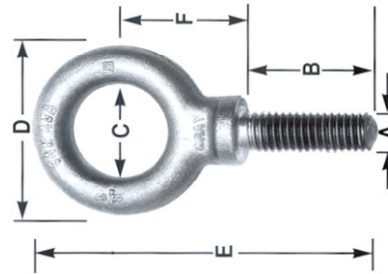

FORGED CARBON STEEL

MÉTRIQUE DIN 580 DISPONIBLE

DIN 580 METRIC AVAILABLE

NOTRE CODE	THREAD SIZE	SHANK LGHT.	I.D. EYE	O.D. EYE	OVERALL LGTH	CENTER OF EYE TO SHDR.	RATED CAPACITY
OUR CODE	A	B	C	D	E	F	
EB000250	1/4-20	1	3/4	1 3/16	2 3/8	3/4	500
EB000315	5/16-18	1 1/8	7/8	1 7/16	2 13/16	15/16	900
EB000375	3/8-16	1 1/4	1	1 11/16	3 9/32	1 1/8	1300
EB000437	7/16-14	1 3/8	1 3/32	1 13/16	3 9/16	1 1/4	1800
EB000500	1/2-13	1 1/2	1 3/16	2 1/8	3 31/32	1 3/8	2400
EB000562	9/16-12	1 3/4	1 3/8	2 9/16	4 3/4	1 21/32	3200
EB000625	5/8-11	1 3/4	1 3/8	2 9/16	4 3/4	1 21/32	4000
EB000750	3/4-10	2	1 1/2	2 13/16	5 1/4	1 13/16	5000
EB000875	7/8-9	2 1/4	1 11/16	3 3/16	5 31/32	2 1/8	7000
EB001000	1-8	2 1/2	1 13/16	3 9/16	6 5/8	2 5/16	9000
EB001125	1 1/8-7	2 3/4	2	4 1/16	7 17/32	2 11/16	12000
EB001250	1 1/4-6	3	2 3/16	4 7/16	8 7/32	2 15/16	15000
EB001500	1 1/2-6	3 1/2	2 1/2	5 3/16	9 15/32	3 5/16	21000
EB001750	1 3/4-5	3 3/4	2 7/8	6	10 13/16	4	28000
EB002000	2-4 1/2	4	3 1/4	6 7/8	11 7/8	4 3/8	38000

DISPONIBLE SANS ÉPAULEMENT / WITHOUT SHOULDER IS AVAILABLE
 SS-316 DISPONIBLE SUR DEMANDE / SS-316 AVAILABLE ON REQUEST



BOULONS À ŒIL AVEC ÉCROUS



EYE BOLTS AND NUTS

NOTRE CODE	# REF	DIA. FILETAGE	LONGUEUR TOTALE	DIA. INT. ŒILLET	LONGUEUR FILETAGE	LONGUEUR TIGE
OUR CODE	# REF	THREAD DIA.	OVERALL LENGTH	EYE INSIDE DIA.	THREAD LENGTH	SHANK LENGTH
EB018020	5102	3/16	2	3/8	1 1/8	1 5/16
EB018025	5104	3/16	2 1/2	3/8	1 5/8	1 3/4
EB025020	5106	1/4	2	9/16	7/8	1
EB025025	5107	1/4	2 1/2	9/16	1 3/8	1 1/2
EB025030	5108	1/4	3	9/16	1 3/4	2
EB025040	5109	1/4	4	9/16	2 3/4	3
EB025050	5110	1/4	5	9/16	3	4
EB025060	5111	1/4	6	7/16	3	5
EB031032	5112	5/16	3 1/4	11/16	1 3/4	2
EB031040	5113	5/16	4	11/16	2 1/2	2 3/4
EB031050	5114	5/16	5	11/16	3	3 3/4
EB031060	5115	5/16	6	11/16	3	4 3/4
EB037040	5117	3/8	4	7/8	2 1/8	2 3/8
EB037050	5118	3/8	5	7/8	3 1/4	3 3/8
EB037060	5119	3/8	6	7/8	3 1/4	4 3/8
EB037080	5120	3/8	8	7/8	3 1/4	6 3/8
EB050060	5226	1/2	6	1 1/4	3	4
*****	5228	1/2	8	1 1/4	3	6
*****	5229	1/2	10	1 1/4	3	8
*****	5230	1/2	12	1 1/4	3	10

AUSSI DISPONIBLE / ALSO AVAILABLE

**PITONS AVEC ÉCROUS AVEC
ÉPAULEMENT / EYE BOLT
SHOULDER & NUTS**



**ÉCROUS À ŒIL voir page C-28
EYE NUTS**



BOULONS EN "U"
AVEC PLAQUE ET ÉCROUS

ZINC / PLATED

"U" BOLTS
WITH PLATE AND HEX NUTS

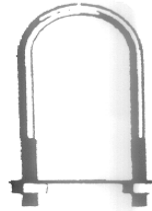

NOTRE CODE	#REF	DIA. FILETAGE (A)	DIA. TUYAU	LARGEUR INTERNE(B)	PROFONDEUR INT.(C)	LONGUEUR FILETAGE(D)
OUR CODE	# REF	THREAD DIA.(A)	TO FIT STEEL PIPE	INSIDE WIDTH(B)	INSIDE LENGTH(C)	THREAD LENGTH(D)
UB005121	5121	1/4	3/4	1 1/8	2	7/8
UB005122	5122	5/16	1	1 3/8	2 3/16	1
UB005123	5123	5/16	1 1/4	1 3/4	2 11/16	1
UB005124	5124	5/16	1 1/2	2	2 3/4	1
UB005125	5125	5/16	2	1	3 1/4	1 1/4
UB005161	5161	5/16	1	1 3/8	3 11/16	2 3/8
UB005162	5162	5/16	1 1/4	1 3/4	4 3/16	2 3/4
*****	5164	5/16	1 1/2	2	4 11/16	3
UB005166	5166	5/16	2	2 1/2	5 3/16	3 1/8

POUR AUTRES DIMENSIONS, CE QUE NOUS AVONS BESOIN DE SAVOIR
THINGS WE NEED TO KNOW FOR OTHER DIMENSIONS

A: _____
B: _____
C: _____
D: _____

MATÉRIEL/MATERIAL: _____

QTÉ/QTY: _____

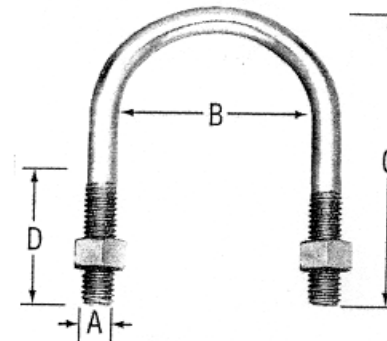

A-111



Tel.: (819) 346-2903 / (888) 345-2903 Fax.: (819) 346-3389
Email: distributeur@boulonstrie.com

SECTION B

VIS À PRESSION / SOCKET SCREWS

INFORMATION TECHNIQUE.....DÉBUT DE LA SECTION
 TECHNICAL INFORMATION.....BEGINNING OF THIS SECTION

DESCRIPTION	SECTION - PAGE
 <p>VIS À TÊTE CYLINDRIQUE À 6 PANS CREUX, <i>GROS FILETS</i>, NOIR. SOCKET HEAD CAP SCREWS, <i>NATIONAL COARSE</i>, BARE.</p>	B-1
 <p>VIS À TÊTE CYLINDRIQUE À 6 PANS CREUX, <i>GROS FILETS</i>, ZINC. SOCKET HEAD CAP SCREWS, <i>NATIONAL COARSE</i>, PLATED.</p>	SUR DEMANDE ON REQUEST
 <p>VIS À TÊTE CYLINDRIQUE À 6 PANS CREUX, <i>FILETS FINS</i>, NOIR. SOCKET HEAD CAP SCREWS, <i>NATIONAL FINE</i>, BARE.</p>	B-11
 <p>VIS À TÊTE CYLINDRIQUE À 6 PANS CREUX, <i>FILETS FINS</i>, ZINC. SOCKET HEAD CAP SCREWS, <i>NATIONAL FINE</i>, PLATED.</p>	SUR DEMANDE ON REQUEST
 <p>VIS À TÊTE CYLINDRIQUE À 6 PANS CREUX, <i>GROS FILETS & FINS</i>, SS-304/ 18-8. SOCKET HEAD CAP SCREWS, <i>NATIONAL COARSE & FINE</i>, SS-304/ 18-8.</p>	B-17
 <p>VIS À TÊTE CYLINDRIQUE À 6 PANS CREUX, <i>GROS FILETS</i>, SS-316. SOCKET HEAD CAP SCREWS, <i>NATIONAL COARSE</i>, SS-316.</p>	B-20
 <p>VIS À TÊTE CYLINDRIQUE À 6 PANS CREUX, <i>MÉTRIQUE</i>, GRADE 12.9, NOIR. SOCKET HEAD CAP SCREWS, <i>METRIC</i>, <i>GRADE 12.9</i>, BARE.</p>	B-21
 <p>VIS À TÊTE CYLINDRIQUE À 6 PANS CREUX, <i>MÉTRIQUE</i>, SS-304 & SS-316. SOCKET HEAD CAP SCREWS, <i>METRIC</i>, SS-304 & SS-316.</p>	SUR DEMANDE ON REQUEST
 <p>VIS À TÊTE BASSE À 6 PANS CREUX, <i>GROS FILETS</i>, NOIR. LOW HEAD SOCKET CAP SCREWS, <i>NATIONAL COARSE</i>, BARE</p>	B-29
 <p>VIS À TÊTE BASSE À 6 PANS CREUX, <i>MÉTRIQUE DIN 7984</i>, NOIR. LOW HEAD SOCKET CAP SCREWS, <i>METRIC DIN7984</i>, BARE.</p>	B-31
 <p>VIS À TÊTE FRAISÉE À 6 PANS CREUX, <i>GROS FILETS</i>, NOIR. FLAT HEAD SOCKET CAP SCREWS, <i>NATIONAL COARSE</i>, BARE.</p>	B-32
 <p>VIS À TÊTE FRAISÉE À 6 PANS CREUX, <i>GROS FILETS</i>, ZINC. FLAT HEAD SOCKET CAP SCREWS, <i>NATIONAL COARSE</i>, PLATED</p>	SUR DEMANDE ON REQUEST

SECTION B

VIS À PRESSION / SOCKET SCREWS

	DESCRIPTION	SECTION - PAGE
	VIS À TÊTE FRAISÉE À 6 PANS CREUX, <i>FILETS FINS</i> , NOIR. FLAT HEAD SOCKET CAP SCREWS, <i>NATIONAL FINE</i> , BARE.	B-37
	VIS À TÊTE FRAISÉE À 6 PANS CREUX, <i>FILETS FINS</i> , ZINC. FLAT HEAD SOCKET CAP SCREWS, <i>NATIONAL FINE</i> , PLATED	SUR DEMANDE ON REQUEST
	VIS À TÊTE FRAISÉE À 6 PANS CREUX, <i>GROS FILETS & FINS</i> , SS-304. FLAT HEAD SOCKET CAP SCREWS, <i>NATIONAL COARSE & FINE</i> , SS-304.	B-40
	VIS À TÊTE FRAISÉE À 6 PANS CREUX, <i>MÉTRIQUE</i> , GRADE 10.9, NOIR. FLAT HEAD SOCKET CAP SCREWS, <i>METRIC</i> , GRADE 10.9, BARE.	B-42
	VIS À TÊTE FRAISÉE À 6 PANS CREUX, <i>MÉTRIQUE</i> , A2 (304) & 316 FLAT HEAD SOCKET CAP SCREWS, <i>METRIC</i> , A2 (304) & 316	SUR DEMANDE ON REQUEST
	VIS DE PRESSION À 6 PANS CREUX, <i>GROS FILETS</i> , NOIR. SOCKET SET SCREWS CUP POINT, <i>NATIONAL COARSE</i> , BARE .	B-45
	VIS DE PRESSION À 6 PANS CREUX, <i>GROS FILETS</i> , ZINC. SOCKET SET SCREWS CUP POINT, <i>NATIONAL COARSE</i> , PLATED .	SUR DEMANDE ON REQUEST
	VIS DE PRESSION À 6 PANS CREUX, <i>FILETS FINS</i> , NOIR. SOCKET SET SCREWS CUP POINT, <i>NATIONAL FINE</i> , BARE .	B-50
	VIS DE PRESSION À 6 PANS CREUX, <i>FILETS FINS</i> , ZINC. SOCKET SET SCREWS CUP POINT, <i>NATIONAL FINE</i> , PLATED .	SUR DEMANDE ON REQUEST
	VIS DE PRESSION À 6 PANS CREUX, <i>GROS FILETS & FINS</i> , SS-304. SOCKET SET SCREWS CUP POINT, <i>NATIONAL COARSE & FINE</i> , SS-304 .	B-54
	VIS DE PRESSION À 6 PANS CREUX <i>MÉTRIQUE</i> , GRADE 12.9 NOIR. SOCKET SET SCREWS CUP POINT, <i>METRIC</i> , GRADE 12.9, BARE.	B-56
	VIS DE PRESSION À 6 PANS CREUX <i>MÉTRIQUE</i> , A2 (SS-304) & SS-316. SOCKET SET SCREWS CUP POINT, <i>METRIC</i> , A2 (SS-304) & SS-316.	SUR DEMANDE ON REQUEST

SECTION B

VIS À PRESSION / SOCKET SCREWS

	DESCRIPTION	SECTION - PAGE
	VIS DE PRESSION À 6 PANS CREUX, <i>POINTE CONIQUE</i>. SOCKET SET SCREWS CUP POINT, <i>CONE POINT</i>.	SUR DEMANDE ON REQUEST
	VIS DE PRESSION À 6 PANS CREUX, <i>POINTE DEMI-TÉTON</i>. SOCKET SET SCREWS CUP POINT, <i>HALF DOG POINT</i>.	SUR DEMANDE ON REQUEST
	VIS DE PRESSION À 6 PANS CREUX, <i>POINTE MOLETÉE</i>. SOCKET SET SCREWS CUP POINT, <i>KNURLED POINT</i>.	SUR DEMANDE ON REQUEST
	VIS DE PRESSION À 6 PANS CREUX, <i>POINTE OVALE</i>. SOCKET SET SCREWS CUP POINT, <i>OVAL POINT</i>.	SUR DEMANDE ON REQUEST
	VIS DE PRESSION À 6 PANS CREUX, <i>POINTE PLATE</i>. SOCKET SET SCREWS CUP POINT, <i>FLAT POINT</i>.	SUR DEMANDE ON REQUEST
	VIS À TÊTE RONDE À 6 PANS CREUX, <i>GROS FILETS</i>, NOIR. BUTTON HEAD SOCKET CAP SCREWS, <i>NATIONAL COARSE</i>, BARE.	B-59
	VIS À TÊTE RONDE À 6 PANS CREUX, <i>GROS FILETS</i>, ZINC. BUTTON HEAD SOCKET CAP SCREWS, <i>NATIONAL COARSE</i>, PLATED.	SUR DEMANDE ON REQUEST
	VIS À TÊTE RONDE À 6 PANS CREUX, <i>FILETS FINS</i>, NOIR. BUTTON HEAD SOCKET CAP SCREWS, <i>NATIONAL FINE</i>, BARE.	B-62
	VIS À TÊTE RONDE À 6 PANS CREUX, <i>FILETS FINS</i>, ZINC. BUTTON HEAD SOCKET CAP SCREWS, <i>NATIONAL FINE</i>, PLATED.	SUR DEMANDE ON REQUEST
	VIS À TÊTE RONDE À 6 PANS CREUX, <i>GROS FILETS & FINS</i>, SS-304/ 18-8. BUTTON HEAD SOCKET CAP SCREWS, <i>NATIONAL COARSE & FINE</i>, SS-304/ 18-8.	B-64
	VIS À TÊTE RONDE À 6 PANS CREUX, <i>MÉTRIQUE</i>, GRADE 12.9, NOIR. BUTTON HEAD SOCKET CAP SCREWS, <i>METRIC</i>, GRADE 12.9, BARE.	B-66
	VIS À ÉPAULEMENT À TÊTE CREUSE 6 PANS CREUX, <i>GROS FILETS</i>, NOIR. SOCKET HEAD SHOULDER SCREWS, <i>NATIONAL COARSE</i>, BARE.	B-67
	VIS À ÉPAULEMENT À TÊTE CREUSE 6 PANS CREUX, <i>GROS FILETS</i>, ZINC. SOCKET HEAD SHOULDER SCREWS, <i>NATIONAL COARSE</i>, PLATED.	SUR DEMANDE ON REQUEST





SECTION B

VIS À PRESSION / SOCKET SCREWS

DESCRIPTION	SECTION - PAGE
 <p>VIS À ÉPAULEMENT À TÊTE CREUSE 6 PANS CREUX, <i>MÉTRIQUE DIN 9841</i>, NOIR. SOCKET HEAD SHOULDER SCREWS, <i>METRIC DIN 9841</i>, BARE.</p>	B-73
 <p>VIS À ÉPAULEMENT À TÊTE CREUSE 6 PANS CREUX, SS304. SOCKET HEAD SHOULDER SCREWS, SS304</p>	SUR DEMANDE ON REQUEST
 <p>VIS DE PRESSION À TÊTE CARRÉE, <i>GROS FILETS</i>, NOIR. SQUARE HEAD SET SCREWS, <i>NATIONAL COARSE</i>, BARE.</p>	B-75
 <p>VIS DE PRESSION À TÊTE CARRÉE, <i>MÉTRIQUE DIN 479</i>, NOIR. SQUARE HEAD SET SCREWS, <i>METRIC DIN 479</i>, BARE.</p>	SUR DEMANDE ON REQUEST
 <p>BOUCHONS FILETÉS HEXAGONAUX, NOIR PIPE PLUGS HEX, BARE</p>	B-78
 <p>BOUCHONS FILETÉS HEXAGONAUX ACIER INOXYDABLE & MÉTRIQUE PIPE PLUGS HEX STAINLESS STEEL & METRIC</p>	SUR DEMANDE ON REQUEST
 <p>CLÉS HEXAGONALES, COURTE & LONGUE, NOIR HEX KEYS "ALLEN", SHORT & LONG, BARE.</p>	B-79
 <p>CLÉS HEXAGONALES, <i>MÉTRIQUE</i>, COURTE & LONGUE, NOIR. HEX KEYS "ALLEN", <i>METRIC</i>, SHORT & LONG, BARE.</p>	B-80
 <p>CLÉS HEXAGONALES, <i>MÉTRIQUE</i>, BOUT EN ROND. COURTE & LONGUE, NOIR. HEX KEYS "ALLEN", <i>METRIC</i>, BALL POINT. SHORT & LONG, BARE.</p>	B-80
 <p>CLÉS HEXAGONALES BOUT EN ROND, NOIR. HEX. KEYS "ALLEN", BALL POINT, BARE.</p>	B-81
 <p>TOURNEVIS HEXAGONE, BOUT EN ROND HEX SCREWDRIVERS, BALL POINT</p>	B-81
 <p>CLÉS ALLEN MANCHE EN T, BOUT ROND. ALLEN KEYS T-HANDLE, BALL POINT.</p>	B-82
 <p>JEUX DE CLÉS, BOUT EN ROND, ZINC. ALLEN KEYS SETS, BALL POINT, PLATED.</p>	B-82

SECTION B

VIS À PRESSION / SOCKET SCREWS

	DESCRIPTION	SECTION - PAGE
	JEUX DE CLÉS, BOUT EN ROND, NOIR. ALLEN KEYS SETS, BALL POINT, BARE.	B-83
	ENS. CLÉS HEXAGONALES HEX FOLD UP KEY SETS	B-83
	TOURNEVIS BOUT EN ROND BALL POINT SCREWDRIVERS	B-83
	ENSEMBLES DOUBLES DOUBLE PACKS	B-83
	ENSEMBLE TRIPLE TRIPLE PACK	B-83

DIMENSIONS OF SOCKET HEAD CAP SCREWS

CLASS FIT 3A
HARDNESS RC 38-43

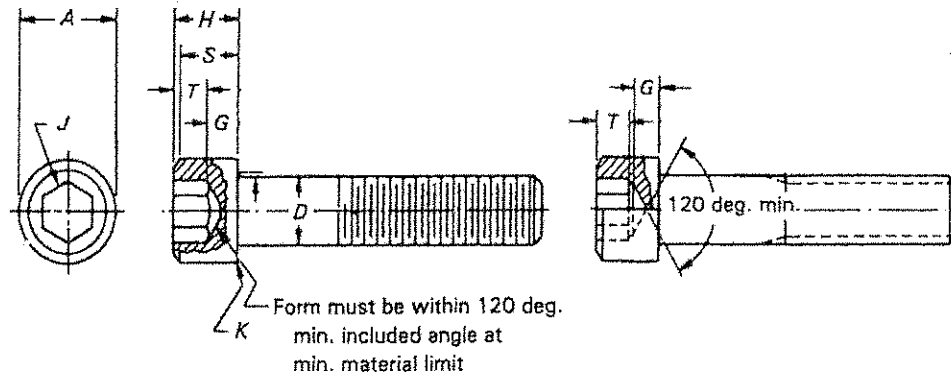

Nominal Size or Basic Screw Diameter	D		A		H		S	J	T	G	K		
	Body Diameter		Head Diameter		Head Height		Head Side Height	Hexagon Socket Size	Key Engagement	Wall Thickness	Chamfer of Radius		
	Max.	Min.	Max.	Min.	Max.	Min.	Min.	Norm.	Min.	Min.	Max.		
0	0.0600	0.0600	0.0568	0.096	0.091	0.060	0.057	0.054		0.050	0.025	0.020	0.003
1	0.0730	0.0730	0.0504	0.118	0.112	0.073	0.070	0.066	1/16	0.062	0.031	0.025	0.003
2	0.0860	0.0860	0.0822	0.140	0.134	0.086	0.083	0.077	5/64	0.078	0.038	0.029	0.003
3	0.0990	0.0990	0.0949	0.161	0.154	0.099	0.095	0.089	5/64	0.078	0.044	0.034	0.003
4	0.1120	0.1120	0.1075	0.183	0.176	0.112	0.108	0.101	3/32	0.094	0.051	0.030	0.005
5	0.1250	0.1250	0.1202	0.205	0.198	0.125	0.121	0.112	3/32	0.094	0.057	0.043	0.005
6	0.1380	0.1380	0.1329	0.226	0.218	0.138	0.134	0.124	7/64	0.109	0.064	0.047	0.005
8	0.1640	0.1640	0.1585	0.270	0.262	0.164	0.159	0.148	9/64	0.141	0.077	0.056	0.005
10	0.1900	0.1900	0.1840	0.312	0.303	0.190	0.185	0.171	5/32	0.156	0.090	0.065	0.005
12	0.216	0.2160	0.2100	0.324	0.314	0.216	0.210	0.194	5/32	0.156	0.103	0.073	0.005
1/4	0.2500	0.2500	0.2435	0.375	0.365	0.250	0.244	0.225	3/16	0.188	0.120	0.095	0.008
5/16	0.3125	0.3125	0.3053	0.469	0.457	0.312	0.306	0.281	1/4	0.250	0.151	0.119	0.008
3/8	0.3750	0.3750	0.3678	0.561	0.550	0.375	0.368	0.337	5/16	0.312	0.182	0.143	0.008
7/16	0.4375	0.4375	0.4294	0.656	0.642	0.438	0.430	0.394	3/8	0.375	0.213	0.166	0.010
1/2	0.5000	0.5000	0.4919	0.750	0.735	0.500	0.492	0.450	3/8	0.375	0.245	0.190	0.010
5/8	0.6250	0.6250	0.6163	0.938	0.921	0.625	0.616	0.562	1/2	0.500	0.307	0.238	0.010
3/4	0.7500	0.7500	0.7406	1.125	1.107	0.750	0.740	0.675	5/8	0.625	0.370	0.285	0.010
7/8	0.8750	0.8750	0.8647	1.312	1.293	0.875	0.864	0.787	3/4	0.750	0.432	0.333	0.015
1	1.0000	1.0000	0.9886	1.500	1.479	1.000	0.988	0.900	3/4	0.750	0.495	0.380	0.015
1-1/8	1.1250	1.1250	1.1086	1.688	1.665	1.125	1.111	1.012	7/8	0.875	0.557	0.428	0.015
1-1/4	1.2500	1.2500	1.2336	1.875	1.852	1.250	1.236	1.125	7/8	0.875	0.620	0.475	0.015
1-3/8	1.3750	1.3750	1.3568	2.062	2.038	1.375	1.360	1.237	1	1.000	0.682	0.523	0.015
1-1/2	1.5000	1.5000	1.4818	2.250	2.224	1.500	1.485	1.350	1	1.000	0.745	0.570	0.015
1-3/4	1.7500	1.7500	1.7295	2.625	2.597	1.750	1.734	1.575	1-1/4	1.250	0.870	0.665	0.015
2	2.0000	2.0000	1.9780	3.000	2.970	2.000	1.983	1.800	1-1/2	1.500	0.995	0.760	0.015
2-1/4	2.2500	2.2500	2.2280	3.375	3.344	2.250	2.232	2.025	1-3/4	1.750	1.120	0.855	0.031
2-1/2	2.5000	2.5000	2.4762	3.750	3.717	2.500	2.481	2.250	1-3/4	1.750	1.245	0.950	0.031
2-3/4	2.7500	2.7500	2.7262	4.125	4.090	2.750	2.730	2.475	2-1/4	2.000	1.370	1.045	0.031
3	3.0000	3.0000	2.9762	4.500	4.464	3.000	2.979	2.700	2-1/4	2.250	1.495	1.140	0.031
3-1/4	3.2500	3.2500	3.2262	4.875	4.837	3.250	3.228	2.925	2-1/4	2.250	1.620	1.235	0.031
3-1/2	3.5000	3.5000	3.4762	5.250	5.211	3.500	3.478	3.150	2-3/4	2.750	1.745	1.330	0.031
3-3/4	3.7500	3.7500	3.7262	5.625	5.584	3.750	3.727	3.375	2-3/4	2.750	1.870	1.425	0.031
4	4.0000	4.0000	3.9762	6.000	5.958	4.000	3.976	3.600	3-1/4	3.000	1.995	1.520	0.031

DIMENSIONS OF FLAT COUNTERSUNK SOCKET HEAD CAP SCREWS

**CLASS FIT 3A
HARDNESS RC 36-43**

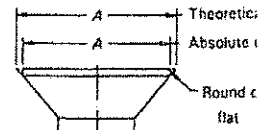
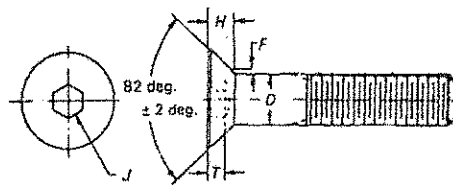

Nominal Size or Basic Screw Diameter	D		A		H		J	T	F	
	Body Diameter		Head Diameter		Head Height					
	Max.	Min.	Theoretical Sharp Max.	Abs. Min.	Reference	Flushness Tolerance	Hexagon Socket Size	Key Engagement Min.	Fillet Extension Above D Max.	
			Max.	Min.						
10	0.0600	0.0600	0.0568	0.138	0.117	0.044	0.006	0.035	0.025	0.006
11	0.0730	0.0730	0.0695	0.168	0.143	0.054	0.007	0.050	0.031	0.008
12	0.0860	0.0860	0.0822	0.197	0.168	0.064	0.008	0.050	0.038	0.010
13	0.0990	0.0990	0.0949	0.226	0.193	0.073	0.010	1/16 0.062	0.044	0.010
4	0.1120	0.1120	0.1075	0.255	0.218	0.083	0.011	1/16 0.062	0.055	0.012
5	0.1250	0.1250	0.1202	0.281	0.240	0.090	0.012	5/64 0.078	0.061	0.014
6	0.1380	0.1380	0.1329	0.307	0.263	0.097	0.013	5/64 0.078	0.066	0.015
8	0.1640	0.1640	0.1585	0.359	0.311	0.112	0.014	3/32 0.094	0.076	0.015
10	0.1900	0.1900	0.1840	0.411	0.359	0.127	0.015	1/8 0.125	0.087	0.015
1/4	0.2500	0.2500	0.2435	0.531	0.480	0.161	0.016	5/32 0.156	0.111	0.015
5/16	0.3125	0.3125	0.3053	0.656	0.600	0.198	0.017	3/16 0.188	0.135	0.015
3/8	0.3750	0.3750	0.3678	0.781	0.720	0.234	0.018	7/32 0.219	0.159	0.015
7/16	0.4375	0.4375	0.4294	0.844	0.781	0.234	0.018	1/4 0.250	0.159	0.015
1/2	0.5000	0.5000	0.4919	0.938	0.872	0.251	0.018	5/16 0.312	0.172	0.015
5/8	0.6250	0.6250	0.6163	1.188	1.112	0.324	0.022	3/8 0.375	0.220	0.015
3/4	0.7500	0.7500	0.7406	1.438	1.355	0.396	0.024	1/2 0.500	0.220	0.015
7/8	0.8750	0.8750	0.8647	1.688	1.604	0.468	0.025	9/16 0.562	0.248	0.015
1	1.0000	1.0000	0.9886	1.938	1.841	0.540	0.028	5/8 0.625	0.297	0.015
1-1/8	1.1250	1.1250	1.1086	2.188	2.079	0.611	0.031	3/4 0.750	0.325	0.031
1-1/4	1.2500	1.2500	1.2336	2.438	2.316	0.683	0.035	7/8 0.875	0.358	0.031
1-3/8	1.3750	1.3750	1.3568	2.688	2.553	0.755	0.038	7/8 0.875	0.402	0.031
1-1/2	1.5000	1.5000	1.4848	2.938	2.791	0.827	0.042	1 1.000	0.435	0.031

DIMENSIONS OF LOW-HEAD SOCKET HEAD CAP SCREWS

**CLASS FIT 3A
HARDNESS RC 38-43**

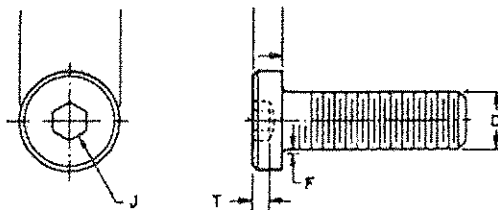

Nominal Size	Basic Screw Diam. D	A-Head Diameter		H-Head Height		J Hex Socket Size	T Key Engagement Min.	F Fillet Above D	
		Max.	Min.	Max.	Min.			Max.	Min.
4	0.1120	.183	.178	.056	.053	.0500	.038	.009	.005
5	0.1250	.205	.200	.062	.059	.0625	.044	.010	.006
6	0.1380	.226	.221	.069	.066	.0625	.050	.010	.006
8	0.1640	.270	.265	.082	.079	.0781	.060	.012	.007
10	0.1900	.312	.307	.095	.092	.093	.072	.014	.009
1/4	0.2500	.375	.369	.125	.121	.1250	.094	.014	.009
5/16	0.3125	.437	.431	.156	.152	.1562	.120	.017	.012
3/8	0.3750	.562	.556	.187	.182	.1875	.145	.020	.015
7/16	0.4375	.625	.618	.218	.213	.2188	.166	.023	.018
1/2	0.5000	.750	.743	.250	.244	.2500	.184	.026	.020
5/8	0.6250	.875	.867	.312	.306	.3125	.250	.032	.024

DIMENSIONS OF SOCKET SET SCREWS

CLASS FIT 3A
HARDNESS RC 45-53

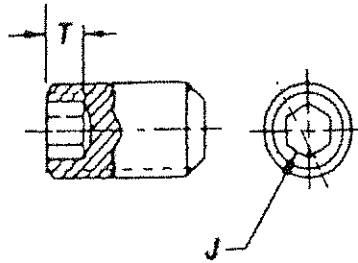

OVAL POINT

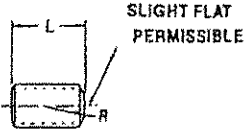

CUP POINT
(KNURL)

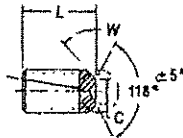

FLAT POINT

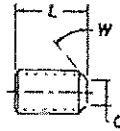

HALF DOG POINT

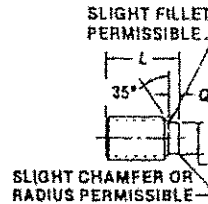

CONE POINT

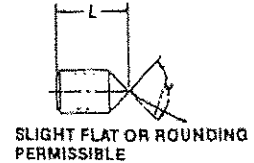

Nominal Size or Basic Screw Diameter	J		T		C		R	Y	P		Q		Recommended Seating Torque (Inch-lbs.)		
	Hexagon Socket Size		Min Key Engagement to Develop Functional Capability of Key		Cup and Flat Point Diameters		Oval Point Radius	Cone Point Angle 90° ± 2 Deg These Lengths or Longer	Half Dog Point						
			Hex Socket 7 _H Min		Max	Min	Basic	118° ± 2 Deg for Shorter Nominal Lengths	Diameter		Length		Alloy Steel	Stainless	Nom. Min. Screw Length
	Nom								Max	Min	Max	Min			
0	0.0600	0.028	0.050	0.033	0.027	0.045	0.09	0.040	0.037	0.017	0.013	1.0	.4	3/32	
1	0.0730	0.028	0.060	0.040	0.033	0.055	0.09	0.049	0.045	0.021	0.017	1.8	1.2	1/8	
2	0.0860	0.035	0.060	0.047	0.039	0.064	0.13	0.057	0.053	0.024	0.020	1.8	1.2	1/8	
3	0.0990	0.050	0.070	0.054	0.045	0.074	0.13	0.066	0.062	0.027	0.023	5	4	5/32	
4	0.1120	0.050	0.070	0.061	0.051	0.084	0.19	0.075	0.070	0.030	0.026	5	4	5/32	
5	0.1250	1/16	0.080	0.067	0.057	0.094	0.19	0.083	0.078	0.033	0.027	10	7	5/32	
6	0.1380	1/16	0.080	0.074	0.064	0.104	0.19	0.092	0.087	0.038	0.032	10	7	3/16	
8	0.1640	5/64	0.090	0.087	0.076	0.123	0.25	0.109	0.103	0.043	0.037	20	16	3/16	
10	0.1900	3/32	0.100	0.102	0.088	0.142	0.25	0.127	0.120	0.049	0.041	36	26	3/16	
1/4	0.2500	1/8	0.125	0.132	0.118	0.188	0.31	0.156	0.149	0.067	0.059	87	70	5/16	
5/16	0.3125	5/32	0.156	0.172	0.156	0.234	0.38	0.203	0.195	0.082	0.074	165	130	3/8	
3/8	0.3750	3/16	0.188	0.212	0.194	0.281	0.44	0.250	0.241	0.099	0.089	290	230	7/16	
7/16	0.4375	7/32	0.219	0.252	0.232	0.328	0.50	0.297	0.287	0.114	0.104	430	340	1/2	
1/2	0.5000	1/4	0.250	0.291	0.270	0.375	0.57	0.344	0.334	0.130	0.120	620	500	9/16	
5/8	0.6250	5/16	0.312	0.371	0.347	0.469	0.75	0.469	0.456	0.164	0.148	1,325	980	11/16	
3/4	0.7500	3/8	0.375	0.450	0.425	0.562	0.88	0.562	0.549	0.196	0.180	2,400	1,700	3/4	
7/8	0.8750	1/2	0.500	0.530	0.502	0.656	1.00	0.658	0.642	0.227	0.211	3,600	3,000	3/4	
1-1/8	1.0000	9/16	0.562	0.609	0.579	0.750	1.13	0.750	0.734	0.260	0.240	5,000	4,000	7/8	
1-1/8	1.1250	9/16	0.562	0.689	0.655	0.844	1.25	0.844	0.826	0.291	0.271	7,200	5,600	1	
1-1/4	1.2500	5/8	0.625	0.767	0.733	0.938	1.50	0.938	0.920	0.323	0.303	9,600	7,700	1-1/8	
1-3/8	1.3750	5/8	0.625	0.848	0.808	1.031	1.63	1.031	1.011	0.354	0.334	9,600	7,700	1-1/4	
1-1/2	1.5000	3/4	0.750	0.926	0.886	1.125	1.75	1.125	1.105	0.385	0.365	11,320	9,100	1-1/4	

DIMENSIONS OF HEXAGON SOCKET HEAD SHOULDER SCREWS

CLASS FIT 3A
HARDNESS RC 36-43

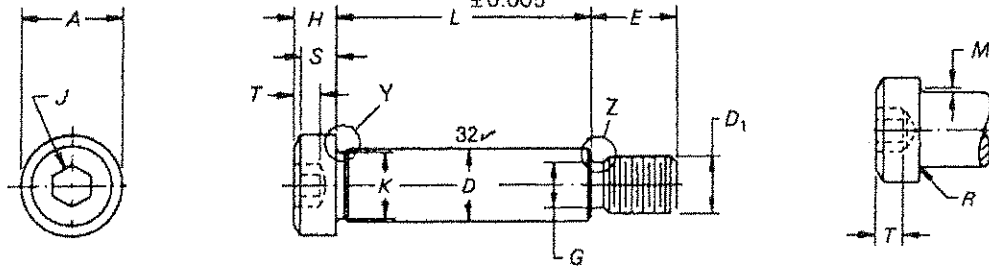

Nominal Size or Basic Shoulder Diameter	D		A		H		S	J		T	M	R	
	Shoulder Diameter		Head Diameter		head Height		Head Side Height	Hexagon Socket Size	Key Engagement	Head Fillet Extension Above D	Head Fillet Radius		
	Max.	Min.	Max.	Min.	Max.	Min.	Min.	Nom.	Min.	Max.	Min.		
1/4	0.250	0.2480	0.2480	0.375	0.357	0.188	0.177	0.157	1/8	0.125	0.094	0.014	0.009
5/16	0.312	0.3105	0.3085	0.438	0.419	0.219	0.209	0.183	5/32	0.156	0.117	0.017	0.012
3/8	0.375	0.3730	0.3710	0.562	0.543	0.250	0.240	0.209	3/16	0.188	0.141	0.020	0.015
1/2	0.500	0.4980	0.4960	0.750	0.729	0.312	0.302	0.262	1/4	0.250	0.188	0.026	0.020
5/8	0.625	0.6230	0.6210	0.875	0.853	0.375	0.365	0.315	5/16	0.312	0.234	0.032	0.024
3/4	0.750	0.7460	0.7460	1.000	0.977	0.500	0.490	0.421	3/8	0.375	0.281	0.039	0.030
1	1.000	0.9980	0.9960	1.312	1.287	0.625	0.610	0.527	1/2	0.500	0.375	0.050	0.040
1-1/4	1.250	1.2480	1.2460	1.750	1.723	0.750	0.735	0.633	5/8	0.625	0.469	0.060	0.050
1-1/2	1.500	1.4980	1.4960	2.125	2.095	1.000	0.980	0.842	7/8	0.875	0.656	0.070	0.060
1-3/4	1.750	1.7480	1.7460	2.375	2.345	1.125	1.105	0.948	1	1.000	0.750	0.080	0.070
2	2.000	1.9980	1.9960	2.750	2.720	1.250	1.230	1.054	1-1/4	1.250	0.937	0.090	0.080

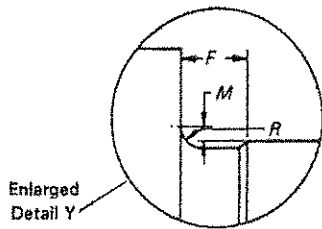

This diam. not to exceed major diam. of thread

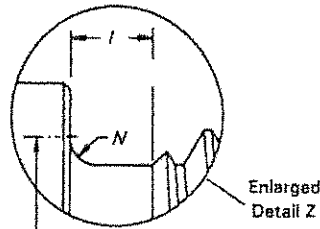

Nominal Size or Basic Shoulder Diameter	K	F	D _t		Threads/in.	G		I	N		E	
	Shoulder Neck Diameter	Shoulder Neck Width	Nominal Thread Size or Basic Thread Diameter			Thread Neck Diameter	Thread Neck Width	Thread Neck Fillet	Thread Length			
	Min.	Max.			Max.	Min.	Max.	Max.	Min.	Basic		
1/4	0.250	0.227	0.093	10	0.1900	24	0.142	0.133	0.083	0.023	0.017	0.375
005/16	0.312	0.289	0.093	1/4	0.2500	20	0.193	0.182	0.100	0.028	0.022	0.438
3/8	0.375	0.352	0.093	5/16	0.3125	18	0.249	0.237	0.111	0.031	0.025	0.500
1/2	0.500	0.477	0.093	3/8	0.3750	16	0.304	0.291	0.125	0.035	0.029	0.625
5/8	0.625	0.602	0.093	1/2	0.5000	13	0.414	0.397	0.154	0.042	0.036	0.750
3/4	0.750	0.727	0.093	5/8	0.6250	11	0.521	0.502	0.182	0.051	0.045	0.875
1	1.000	0.977	0.125	3/4	0.7500	10	0.638	0.616	0.200	0.055	0.049	1.000
1-1/4	1.250	1.227	0.125	7/8	0.8750	9	0.750	0.726	0.222	0.062	0.056	1.125
01-1/2	1.500	1.478	0.125	1-1/8	1.1250	7	0.964	0.934	0.286	0.072	0.066	1.500
1-3/4	1.750	1.728	0.125	1-1/4	1.2500	7	1.089	1.059	0.286	0.072	0.066	1.750
2	2.000	1.978	0.125	1-1/2	1.5000	6	1.307	1.277	0.333	0.102	0.096	2.000

DIMENSIONS OF SQUARE HEAD SET SCREWS

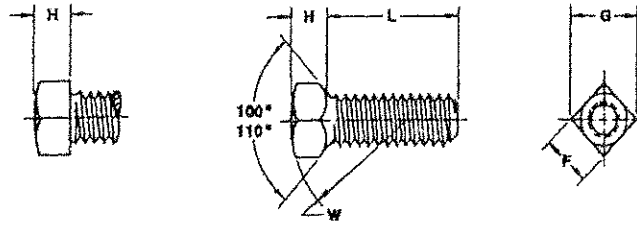

Nominal Size or Basic Screw Diameter	F		G		H		K		S	U	W	
	Width Across Flats		Width Across Corners		Head Height		Neck Relief Diameter		Neck Relief Fillet Radius	Relief Relief Width	Head Radius	
	Max	Min	Max	Min	Max	Min	Max	Min	Max	Min	Min	
10	0.1900	0.188	0.180	0.265	0.247	0.148	0.134	0.145	0.140	0.027	0.083	0.48
1/4	0.2500	0.250	0.241	0.354	0.331	0.196	0.178	0.185	0.170	0.032	0.100	0.62
5/16	0.3125	0.312	0.302	0.442	0.415	0.245	0.224	0.240	0.225	0.036	0.111	0.78
3/8	0.3750	0.375	0.362	0.530	0.497	0.293	0.270	0.294	0.279	0.041	0.125	0.94
7/16	0.4365	0.438	0.423	0.619	0.581	0.341	0.315	0.345	0.330	0.046	0.153	1.09
1/2	0.5000	0.500	0.484	0.707	0.665	0.389	0.361	0.500	0.385	0.050	0.154	1.25
9/16	0.5625	0.562	0.545	0.795	0.748	0.437	0.407	0.454	0.439	0.054	0.167	1.41
5/8	0.6250	0.625	0.606	0.884	0.833	0.485	0.452	0.507	0.492	0.059	0.182	1.56
3/4	0.7500	0.750	0.729	1.060	1.001	0.582	0.544	0.620	0.605	0.065	0.200	1.88
7/8	0.8750	0.875	0.852	1.237	1.170	0.678	0.635	0.731	0.716	0.072	0.222	2.19
1	1.0000	1.000	0.974	1.414	1.337	0.774	0.726	0.838	0.823	0.081	0.250	2.50
1-1/8	1.1250	1.125	1.096	1.591	1.505	0.870	0.817	0.939	0.914	0.092	0.283	2.81
1-1/4	1.2500	1.250	1.219	1.768	1.674	0.966	0.908	1.064	1.039	0.092	0.283	2.12
1-3/8	1.3750	1.375	1.342	1.945	1.843	1.063	1.000	1.159	1.134	0.109	0.333	3.44
1-1/2	1.5000	1.500	1.464	2.121	2.010	1.159	1.091	1.284	1.259	0.109	0.333	3.75

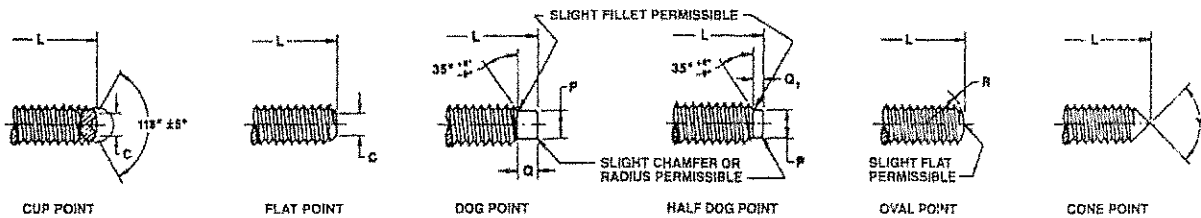

Nominal Size or Basic Screw Diameter	C		P		Q		Q ₁		R	Y	
	Cup and Flat Point Diameters		Dog and Half Dog Point Diameters		Point Length				Oval Point Radius	Cone Point Angle 90° ± 2° For These Nominal Lengths or Longer; 118° ± 2° For Shorter Screws	
	Max	Min	Max	Min	Dog		Half Dog				
10	0.1900	0.102	0.068	0.127	0.120	0.095	0.085	0.050	0.040	0.142	1/4
1/4	0.2500	0.132	0.118	0.156	0.149	0.130	0.120	0.068	0.058	0.188	5/16
5/16	0.3125	0.172	0.156	0.203	0.195	0.161	0.151	0.083	0.073	0.234	3/8
3/8	0.3750	0.212	0.194	0.250	0.241	0.193	0.183	0.099	0.089	0.281	7/16
7/16	0.4365	0.252	0.232	0.297	0.287	0.224	0.214	0.114	0.104	0.328	1/2
1/2	0.5000	0.291	0.270	0.344	0.334	0.255	0.245	0.130	0.120	0.375	9/16
9/16	0.5625	0.332	0.309	0.391	0.379	0.287	0.275	0.146	0.134	0.422	5/8
5/8	0.6250	0.371	0.347	0.469	0.456	0.321	0.305	0.164	0.148	0.469	3/4
3/4	0.7500	0.450	0.425	0.562	0.549	0.383	0.367	0.196	0.180	0.562	7/8
7/8	0.8750	0.530	0.502	0.656	0.642	0.446	0.430	0.227	0.211	0.656	1
1	1.0000	0.609	0.579	0.750	0.734	0.510	0.490	0.260	0.240	0.750	1-1/8
1-1/8	1.1250	0.689	0.655	0.844	0.826	0.572	0.552	0.291	0.271	0.844	1-1/4
1-1/4	1.2500	0.767	0.733	0.938	0.920	0.635	0.615	0.323	0.303	0.938	1-1/2
1-3/8	1.3750	0.848	0.808	1.031	1.011	0.698	0.678	0.354	0.334	1.031	1-5/8
1-1/2	1.5000	0.926	0.886	1.125	1.105	0.760	0.740	0.385	0.365	1.125	1-3/4

DIMENSIONS OF BUTTON SOCKET HEAD CAP SCREWS

CLASS FIT 3A
HARDNESS RC 36-43

Slight flat and/or
countersink
permissible

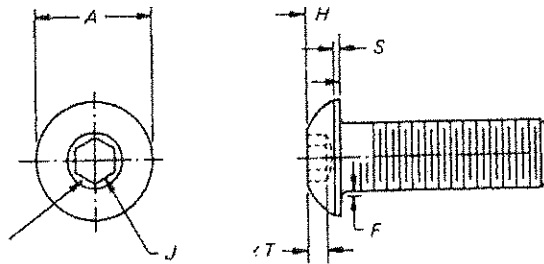

Nominal Size or Basic Screw Diameter	A		H		S	J	T	F		
	Head Diameter		Head Height		Head Side Height	Hexagon Socket Size	Key Engagement	Fillet Extension		
	Max.	Min.	Max.	Min.	Ref.	Nom.	Min.	Max.	Min.	
0	0.0600	0.114	0.104	0.032	0.026	0.010	0.035	0.020	0.010	0.005
1	0.0730	0.139	0.129	0.039	0.033	0.010	0.050	0.028	0.010	0.050
2	0.0860	0.164	0.154	0.046	0.038	0.010	0.050	0.028	0.010	0.050
3	0.0990	0.188	0.176	0.052	0.044	0.010	1/16 0.062	0.035	0.010	0.005
4	0.1120	0.213	0.201	0.059	0.051	0.015	1/16 0.062	0.035	0.010	0.005
5	0.1250	0.238	0.226	0.066	0.058	0.015	5/64 0.078	0.044	0.010	0.005
6	0.1380	0.262	0.250	0.073	0.063	0.015	5/64 0.078	0.044	0.010	0.005
8	0.1640	0.312	0.298	0.087	0.077	0.015	3/32 0.094	0.052	0.015	0.010
10	0.1900	0.361	0.347	0.101	0.091	0.020	1/8 0.125	0.070	0.015	0.010
1/4	0.2500	0.437	0.419	0.132	0.122	0.031	5/32 0.156	0.087	0.020	0.015
5/16	0.3125	0.547	0.527	0.166	0.152	0.031	3/16 0.188	0.105	0.020	0.015
3/8	0.3750	0.656	0.636	0.199	0.185	0.031	7/32 0.219	0.122	0.020	0.015
1/2	0.5000	0.875	0.851	0.265	0.245	0.046	5/16 0.312	0.175	0.030	0.020
5/8	0.6250	1.000	0.970	0.331	0.311	0.062	3/8 0.375	0.210	0.030	0.020

DIMENSIONS OF DOWEL PINS & PULL DOWEL PINS

SURFACE HARDNESS RC 60 min.
CORE HARDNESS RD 50-58
SURFACE FINISH 8 MU max

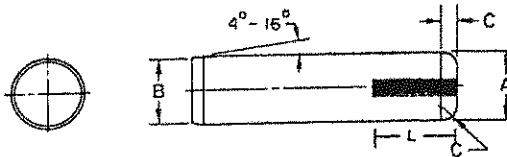

Nominal Size or Nominal Pin Diameter	A						B		C		Double Shear Load Min. lb	L	Tap Size
	Pin Diameter						Point Diameter	Crown Height or Radius	Material Carbon or Alloy Steel				
	Standard Series Pins			Oversize Series Pins						Max	Min	Max	Min
	Basic	Max	Min	Basic	Max	Min							
1/16 0.0625	0.0627	0.0628	0.0626	0.0635	0.0636	0.0634	0.058	0.048	0.020	0.008	800		
5/64 0.0781	0.0783	0.0784	0.0782	0.0791	0.0792	0.0790	0.074	0.064	0.026	0.010	1,240		
3/32 0.0938	0.0940	0.0941	0.0939	0.0948	0.0949	0.0947	0.089	0.079	0.031	0.012	1,800		
1/8 0.1250	0.1252	0.1253	0.1251	0.1260	0.1261	0.1259	0.120	0.110	0.041	0.016	3,200		
5/32 0.1562	0.1564	0.1565	0.1563	0.1572	0.1573	0.1571	0.150	0.140	0.052	0.020	5,000		
3/16 0.1875	0.1877	0.1878	0.1876	0.1885	0.1886	0.1884	0.180	0.170	0.062	0.023	7,200		
1/4 0.2500	0.2502	0.2503	0.2501	0.2510	0.2511	0.2509	0.240	0.230	0.083	0.031	12,800	21/64	6-32
5/16 0.3125	0.3127	0.3128	0.3126	0.3135	0.3136	0.3134	0.302	0.290	0.104	0.039	20,000	21/64	10-32
3/8 0.3750	0.3752	0.3753	0.3751	0.3760	0.3761	0.3759	0.365	0.350	0.125	0.047	28,700	3/8	10-32
7/16 0.4375	0.4377	0.4378	0.4376	0.4385	0.4386	0.4384	0.424	0.409	0.146	0.055	39,100	1/2	1/4-20
1/2 0.5000	0.5002	0.5003	0.5001	0.5010	0.5011	0.5009	0.486	0.471	0.167	0.063	51,000	1/2	1/4-20
5/8 0.6250	0.6252	0.6253	0.6251	0.6260	0.6261	0.6259	0.611	0.595	0.208	0.078	79,800	1/2	1/4-20
3/4 0.7500	0.7502	0.7503	0.7501	0.7510	0.7511	0.7509	0.735	0.715	0.250	0.094	114,000	5/8	5/16-18
7/8 0.8750	0.8752	0.8753	0.8751	0.8760	0.8761	0.8769	0.860	0.840	0.293	0.109	156,000	N/A	N/A
1 1.0000	1.0002	1.0003	1.0001	1.0010	1.0011	1.0009	0.980	0.960	0.333	0.125	204,000	3/4	5/16-18

DIMENSIONS OF SPRING PINS

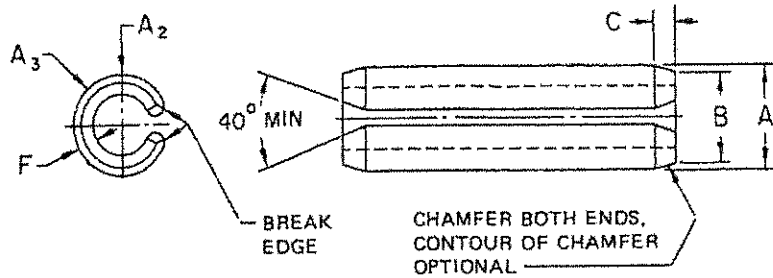

Nominal Size or Basic Pin Diameter	A		B	C		F	Recommended Hole Size		Double Shear Load, Min, lb			
	Pin Diameter		Chamfer Diameter	Chamfer Length		Stock Thickness	Hole Size		Material			
	Max ²	Min ³	Max	Max	Min	Basic	Max	Min	AISI 1070-1095 and AISI 420	AISI 302	Beryllium Copper	
1/16	0.062	0.069	0.066	0.059	0.028	0.007	0.012	0.065	0.062	425	350	270
5/64	0.078	0.086	0.083	0.075	0.032	0.008	0.018	0.081	0.078	650	550	400
3/32	0.094	0.103	0.099	0.091	0.038	0.008	0.022	0.097	0.094	1,000	800	660
1/8	0.125	0.135	0.131	0.122	0.044	0.008	0.028	0.129	0.125	2,100	1,500	1,200
9/64	0.141	0.149	0.145	0.137	0.044	0.008	0.028	0.144	0.140	2,200	1,600	1,400
5/32	0.156	0.167	0.162	0.151	0.048	0.010	0.032	0.160	0.156	3,000	2,000	1,800
3/16	0.188	0.199	0.194	0.182	0.055	0.011	0.040	0.192	0.187	4,400	2,800	2,600
7/32	0.219	0.232	0.226	0.214	0.065	0.011	0.048	0.224	0.219	5,700	3,550	3,700
1/4	0.250	0.264	0.258	0.245	0.066	0.012	0.048	0.256	0.250	7,700	4,600	4,500
5/16	0.312	0.328	0.321	0.306	0.080	0.014	0.062	0.318	0.312	11,500	7,095	6,800
3/8	0.375	0.392	0.385	0.368	0.095	0.016	0.077	0.382	0.375	17,600	10,000	10,100
7/16	0.438	0.456	0.448	0.430	0.095	0.017	0.077	0.445	0.437	20,000	12,000	12,200
1/2	0.500	0.521	0.513	0.485	0.110	0.025	0.094	0.510	0.500	25,800	15,500	16,800
5/8	0.625	0.650	0.640	0.608	0.125	0.030	0.125	0.636	0.625	46,000 ⁴	18,800	...
3/4	0.750	0.780	0.769	0.730	0.150	0.030	0.150	0.764	0.750	66,000 ⁴	23,200	...

DIMENSIONS OF NYLON & BRASS TIP SET SCREW

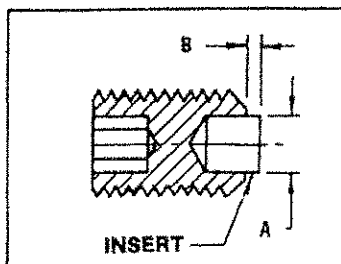

THREAD SIZE	TIP DIAMETER A	TIP PROTRUSION B	THREAD SIZE	TIP DIAMETER A	TIP PROTRUSION B
2-56	1/32	1/32	1/4-28	1/8	1/16
4-40	1/16	1/32	5/16-18	3/16	3/32
6-32	1/16	1/32	5/16-24	3/16	3/32
8-32	3/32	3/64	3/8-16	3/16	3/32
10-24	3/32	3/64	3/8-24	3/16	3/32
10-32	3/32	3/64	1/2-13	1/4	1/8
1/4-20	1/8	1/16	1/2-20	1/4	1/8

KEY APPLICATION CHART

KEY SIZE (W)		SOCKET HEAD CAP SCREW	BUTTON HEAD SCREW	FLAT HEAD SCREW	SHOULDER SCREW	LOW HEAD AND SOCKET SET	PRESSURE PLUGS
MAX.	MIN.						
.028	.0275	-	-	-	-	#0	-
.035	.0345	-	#0	#0	-	#1, #2	-
.050	.049	#0	#1, #2	#1, #2	-	#3, #4	-
1/16	.0615	#1	#3, #4	#3, #4	-	#5, #6	-
5/64	.0771	#2, #3	#5, #6	#5, #6	-	#8	-
3/32	.0927	#4, #5	#8	#8	-	#10	-
7/64	.1079	#6	-	-	-	-	-
1/8	.1235	-	#10	#10	1/4	1/4	-
9/64	.1391	#8	-	-	-	-	-
5/32	.1547	#10	1/4	1/4	5/16	5/16	1/16
3/16	.1860	1/4	5/16	5/16	3/8	3/8	1/8
7/32	.2172	-	3/8	3/8	-	7/16	-
1/4	.2485	5/16	-	7/16	1/2	1/2	1/4
5/16	.3110	3/8	1/2	1/2, 9/16	5/8	5/8	3/8
3/8	.3735	7/16, 1/2	5/8	5/8	3/4	3/4	1/2
7/16	.4355	9/16	-	-	-	-	-
1/2	.4975	5/8	-	3/4	7/8, 1	7/8	-
9/16	.5600	-	-	7/8	-	1, 1 1/8	3/4
5/8	.6225	3/8	-	1	1 1/4	1 1/4, 1 3/8	1
3/4	.7470	7/8, 1	-	-	-	1 1/2	1 1/4, 1 1/2
7/8	.8720	1 1/8, 1 1/4	-	-	1 1/2	-	-
1	.9970	1 3/8, 1 1/2	-	-	1 3/4	1 3/4, 2	1 1/2, 2
1 1/4	1.243	1 3/4	-	-	2	-	-
1 1/2	1.493	2	-	-	-	-	-
1 3/4	1.743	2 1/4, 2 1/2	-	-	-	-	-
2	1.993	2 3/4	-	-	-	-	-



Tel.: (819) 346-2903 / (888) 345-2903 Fax.: (819) 346-3389
 Email: distributeur@boulonsestrie.com

**DIMENSIONS DES
CLÉS HEXAGONALES**

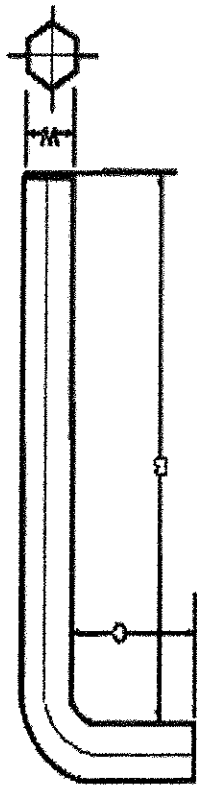

**DIMENSIONS OF
HEXAGON KEYS**

	W		B		C		MIN. TORSIONAL SHEAR-STRENGTH ¹ lb.-In	MIN. TORSIONAL YIELD lb.-In	MINIMUM TORQUE In.-lb
	WRENCH SIZE MAX	MIN	SHORT ARM	NOMINAL LONG ARM	NOMINAL				
.028	.0275	1.219	2.594	.219	1.2	1.1	.86		
.035	.0345	1.219	2.672	.344	2.4	2.1	1.80		
.050	.0490	1.656	2.844	.531	7	6	5.00		
1/16	.0615	1.750	3.000	.562	12	11	9.50		
5/64	.0771	1.875	3.188	.609	26	23	19.40		
3/32	.0927	2.000	3.375	.656	46	40	33.50		
7/64	.1077	2.125	3.562	.703	73	63	52.90		
1/8	.1235	2.250	3.750	.750	108	94	77.90		
9/64	.1391	2.375	3.937	.796	154	134	117.00		
5/32	.1547	2.500	4.125	.844	210	183	156.00		
3/16	.1860	2.750	4.500	.938	364	317	273.00		
7/32	.2172	3.000	4.875	1.031	580	502	428.00		
1/4	.2480	3.250	5.250	1.125	860	750	615.00		
5/16	.3110	3.750	6.000	1.250	1685	1465	1315.00		
3/8	.3730	4.250	6.750	1.375	2900	2520	2150.00		
7/16	.4355	4.750	7.500	1.500	4400	3860	3665.00		
1/2	.4975	5.250	8.250	1.625	6600	5750	5130.00		
9/16	.5600	5.750	9.000	1.750	9200	8000	7010.00		
5/8	.6225	6.250	9.750	1.875	12650	11000	9810.00		
3/4	.7470	7.250	11.250	2.125	20800	18100	15570.00		
7/8	.8720	8.250	12.750	2.375	29200	25400	23400.00		
1	.9970	9.250	14.250	2.625	43700	38000	35100.00		
1 1/4	1.243	11.250	-	3.000	71900	62500	-		
1 1/2	1.493	13.250	-	3.500	124000	108000	-		
1 3/4	1.743	15.250	-	4.000	198000	172000	-		
2	1.993	17.250	-	4.500	276000	240000	-		

VIS À TÊTE CYLINDRIQUE
À 6 PANS CREUX
GROS FILETS

NOIR / BARE
ALLOY STEEL

SOCKET HEAD
CAP SCREWS
NATIONAL COARSE

LA FINITION PLAQUÉE ZINC
EST DISPONIBLE
SUR DEMANDE

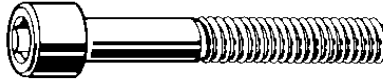

ZINC PLATED IS
AVAILABLE ON REQUEST

NOTRE CODE	DESCRIPTION	QTÉ/BTE	NOTRE CODE	DESCRIPTION	QTÉ/BTE
OUR CODE	DESCRIPTION	QTY/BOX	OUR CODE	DESCRIPTION	QTY/BOX
*****	1-64 X 3/16	SEMI-STD	SH004002	4-40 X 1/4	100
*****	1-64 X 1/4	SEMI-STD	SH004004	4-40 X 3/8	100
*****	1-64 X 5/16	SEMI-STD	SH004005	4-40 X 1/2	100
*****	1-64 X 3/8	SEMI-STD	SH004006	4-40 X 5/8	100
*****	1-64 X 1/2	SEMI-STD	SH004007	4-40 X 3/4	100
*****	1-64 X 5/8	SEMI-STD	*****	4-40 X 7/8	SEMI-STD
*****	1-64 X 3/4	SEMI-STD	SH004010	4-40 X 1	SEMI-STD
*****	1-64 X 1	SEMI-STD	SH004012	4-40 X 1 1/4	SEMI-STD
*****	2-56 X 1/8	SEMI-STD	SH004015	4-40 X 1 1/2	SEMI-STD
*****	2-56 X 3/16	100	SH005002	5-40 X 1/4	100
*****	2-56 X 1/4	100	SH005004	5-40 X 3/8	100
*****	2-56 X 5/16	SEMI-STD	SH005005	5-40 X 1/2	100
SH002004	2-56 X 3/8	100	SH005006	5-40 X 5/8	100
*****	2-56 X 1/2	100	SH005007	5-40 X 3/4	100
*****	2-56 X 5/8	SEMI-STD	SH005010	5-40 X 1	SEMI-STD
*****	2-56 X 3/4	SEMI-STD	SH005012	5-40 X 1 1/4	SEMI-STD
*****	2-56 X 7/8	SEMI-STD	SH005015	5-40 X 1 1/2	SEMI-STD
*****	2-56 X 1	SEMI-STD	SH005020	5-40 X 2	SEMI-STD
*****	3-48 X 1/8	SEMI-STD	*****	6-32 X 1/8	SEMI-STD
*****	3-48 X 3/16	100	SH006001	6-32 X 3/16	SEMI-STD
*****	3-48 X 1/4	100	SH006002	6-32 X 1/4	100
*****	3-48 X 3/8	100	SH006003	6-32 X 5/16	SEMI-STD
*****	3-48 X 1/2	100	SH006004	6-32 X 3/8	100
*****	3-48 X 5/8	SEMI-STD	*****	6-32 X 7/16	SEMI-STD
*****	3-48 X 3/4	SEMI-STD	SH006005	6-32 X 1/2	100
*****	3-48 X 1	SEMI-STD	*****	6-32 X 9/16	SEMI-STD
*****	4-40 X 1/8	SEMI-STD	SH006006	6-32 X 5/8	100
SH004001	4-40 X 3/16	SEMI-STD	SH006007	6-32 X 3/4	100

SEMI-STD DIFFÉRENTES QUANTITÉS DISPONIBLES/SEMI-STD PACKAGING ANY QUANTITY



Tel.: (819) 346-2903 / (888) 345-2903 Fax.: (819) 346-3389

Email: distributeur@boulonsestrie.com

B-1

VIS À TÊTE CYLINDRIQUE
À 6 PANS CREUX
GROS FILETS

NOIR / BARE
ALLOY STEEL

SOCKET HEAD
CAP SCREWS
NATIONAL COARSE

LA FINITION PLAQUÉE ZINC
EST DISPONIBLE
SUR DEMANDE

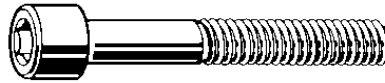

ZINC PLATED IS
AVAILABLE ON REQUEST

NOTRE CODE	DESCRIPTION	QTÉ/BTE	NOTRE CODE	DESCRIPTION	QTÉ/BTE
OUR CODE	DESCRIPTION	QTY/BOX	OUR CODE	DESCRIPTION	QTY/BOX
SH006008	6-32 X 7/8	100	SH008017	8-32 X 1 3/4	SEMI-STD
SH006010	6-32 X 1	100	SH008020	8-32 X 2	SEMI-STD
*****	6-32 X 1 1/8	SEMI-STD	*****	8-32 X 2 1/4	SEMI-STD
SH006012	6-32 X 1 1/4	SEMI-STD	SH008025	8-32 X 2 1/2	SEMI-STD
*****	6-32 X 1 3/8	SEMI-STD	SH008027	8-32 X 2 3/4	SEMI-STD
SH006015	6-32 X 1 1/2	SEMI-STD	SH008030	8-32 X 3	SEMI-STD
SH006017	6-32 X 1 3/4	SEMI-STD	*****	8-32 X 3 1/4	SEMI-STD
SH006020	6-32 X 2	SEMI-STD	*****	8-32 X 3 1/2	SEMI-STD
*****	6-32 X 2 1/4	SEMI-STD	*****	8-32 X 4	SEMI-STD
SH006025	6-32 X 2 1/2	SEMI-STD	*****	10-24 X 3/16	SEMI-STD
SH006027	6-32 X 2 3/4	SEMI-STD	SH010002	10-24 X 1/4	SEMI-STD
SH006030	6-32 X 3	SEMI-STD	SH010003	10-24 X 5/16	SEMI-STD
*****	8-32 X 1/8	SEMI-STD	SH010004	10-24 X 3/8	100
*****	8-32 X 3/16	SEMI-STD	*****	10-24 X 7/16	100
SH008002	8-32 X 1/4	100	SH010005	10-24 X 1/2	100
*****	8-32 X 5/16	SEMI-STD	SH010006	10-24 X 5/8	100
SH008004	8-32 X 3/8	100	*****	10-24 X 9/16	SEMI-STD
*****	8-32 X 7/16	SEMI-STD	SH010007	10-24 X 3/4	100
SH008005	8-32 X 1/2	100	SH010008	10-24 X 7/8	100
SH008009	8-32 X 9/16	SEMI-STD	SH010010	10-24 X 1	100
SH008006	8-32 X 5/8	100	*****	10-24 X 1 1/8	SEMI-STD
SH008007	8-32 X 3/4	100	SH010012	10-24 X 1 1/4	100
*****	8-32 X 7/8	100	*****	10-24 X 1 3/8	SEMI-STD
SH008010	8-32 X 1	100	SH010015	10-24 X 1 1/2	100
*****	8-32 X 1 1/8	SEMI-STD	SH010016	10-24 X 1 5/8	SEMI-STD
SH008012	8-32 X 1 1/4	100	SH010017	10-24 X 1 3/4	100
*****	8-32 X 1 3/8	SEMI-STD	SH010020	10-24 X 2	100
SH008015	8-32 X 1 1/2	100	*****	10-24 X 2 1/4	SEMI-STD

SEMI-STD DIFFÉRENTES QUANTITÉS DISPONIBLES/SEMI-STD PACKAGING ANY QUANTITY



Tel.: (819) 346-2903 / (888) 345-2903 Fax.: (819) 346-3389

Email: distributeur@boulonsestrie.com

VIS À TÊTE CYLINDRIQUE
À 6 PANS CREUX
GROS FILETS

NOIR / BARE
ALLOY STEEL

SOCKET HEAD
CAP SCREWS
NATIONAL COARSE

LA FINITION PLAQUÉE ZINC
EST DISPONIBLE
SUR DEMANDE

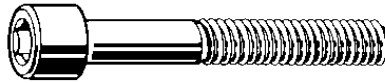

ZINC PLATED IS
AVAILABLE ON REQUEST

NOTRE CODE	DESCRIPTION	QTÉ/BTE	NOTRE CODE	DESCRIPTION	QTÉ/BTE
OUR CODE	DESCRIPTION	QTY/BOX	OUR CODE	DESCRIPTION	QTY/BOX
*****	10-24 X 2 3/8	SEMI-STD	*****	1/4-20 X 9/16	SEMI-STD
SH010025	10-24 X 2 1/2	SEMI-STD	SH025006	1/4-20 X 5/8	100
SH010027	10-24 X 2 3/4	SEMI-STD	SH025007	1/4-20 X 3/4	100
SH010030	10-24 X 3	SEMI-STD	SH025008	1/4-20 X 7/8	100
SH010032	10-24 X 3 1/4	SEMI-STD	SH025010	1/4-20 X 1	SEMI-STD
SH010035	10-24 X 3 1/2	SEMI-STD	*****	1/4-20 X 1 1/8	SEMI-STD
SH010040	10-24 X 4	SEMI-STD	SH025012	1/4-20 X 1 1/4	100
SH010045	10-24 X 4 1/2	SEMI-STD	*****	1/4-20 X 1 3/8	SEMI-STD
*****	10-24 X 5	SEMI-STD	SH025015	1/4-20 X 1 1/2	100
*****	10-24 X 6	SEMI-STD	*****	1/4-20 X 1 5/8	SEMI-STD
*****	12-24 X 3/8	SEMI-STD	SH025017	1/4-20 X 1 3/4	100
*****	12-24 X 1/2	SEMI-STD	SH025020	1/4-20 X 2	100
*****	12-24 X 5/8	SEMI-STD	SH025022	1/4-20 X 2 1/4	100
*****	12-24 X 3/4	SEMI-STD	*****	1/4-20 X 2 3/8	SEMI-STD
*****	12-24 X 7/8	SEMI-STD	SH025025	1/4-20 X 2 1/2	100
*****	12-24 X 1	SEMI-STD	SH025027	1/4-20 X 2 3/4	100
SH012012	12-24 X 1 1/4	SEMI-STD	SH025030	1/4-20 X 3	100
*****	12-24 X 1 1/2	SEMI-STD	SH025032	1/4-20 X 3 1/4	SEMI-STD
*****	12-24 X 1 3/4	SEMI-STD	SH025035	1/4-20 X 3 1/2	100
*****	12-24 X 2	SEMI-STD	SH025040	1/4-20 X 4	100
*****	12-24 X 2 1/4	SEMI-STD	SH025045	1/4-20 X 4 1/2	SEMI-STD
*****	12-24 X 2 1/2	SEMI-STD	SH025050	1/4-20 X 5	SEMI-STD
SH025002	1/4-20 X 1/4	SEMI-STD	*****	1/4-20 X 5 1/2	SEMI-STD
*****	1/4-20 X 5/16	SEMI-STD	SH025060	1/4-20 X 6	SEMI-STD
SH025004	1/4-20 X 3/8	100	*****	1/4-20 X 6 1/2	SEMI-STD
*****	1/4-20 X 7/16	SEMI-STD	*****	1/4-20 X 7	SEMI-STD
SH025005	1/4-20 X 1/2	100	*****	1/4-20 X 8	SEMI-STD

SEMI-STD DIFFÉRENTES QUANTITÉS DISPONIBLES/SEMI-STD PACKAGING ANY QUANTITY



Tel.: (819) 346-2903 / (888) 345-2903 Fax.: (819) 346-3389

Email: distributeur@boulonsestrie.com

VIS À TÊTE CYLINDRIQUE
À 6 PANS CREUX
GROS FILETS

NOIR / BARE
ALLOY STEEL

SOCKET HEAD
CAP SCREWS
NATIONAL COARSE

LA FINITION PLAQUÉE ZINC
EST DISPONIBLE
SUR DEMANDE

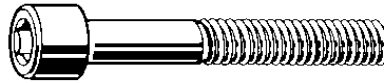

ZINC PLATED IS
AVAILABLE ON REQUEST

NOTRE CODE	DESCRIPTION	QTÉ/BTE	NOTRE CODE	DESCRIPTION	QTÉ/BTE
OUR CODE	DESCRIPTION	QTY/BOX	OUR CODE	DESCRIPTION	QTY/BOX
SH031004	5/16-18 X 3/8	100	*****	5/16-18 X 8	SEMI-STD
SH031005	5/16-18 X 1/2	100	*****	5/16-18 X 9	SEMI-STD
SH031006	5/16-18 X 5/8	100	*****	5/16-18 X 10	SEMI-STD
SH031007	5/16-18 X 3/4	100	*****	3/8-16 X 3/8	SEMI-STD
SH031008	5/16-18 X 7/8	100	SH037005	3/8-16 X 1/2	100
SH031010	5/16-18 X 1	100	SH037006	3/8-16 X 5/8	100
*****	5/16-18 X 1 1/8	SEMI-STD	SH037007	3/8-16 X 3/4	100
SH031012	5/16-18 X 1 1/4	100	SH037008	3/8-16 X 7/8	100
SH031014	5/16-18 X 1 3/8	SEMI-STD	SH037010	3/8-16 X 1	100
SH031015	5/16-18 X 1 1/2	100	*****	3/8-16 X 1 1/8	SEMI-STD
*****	5/16-18 X 1 5/8	SEMI-STD	SH037012	3/8-16 X 1 1/4	100
SH031017	5/16-18 X 1 3/4	100	SH037013	3/8-16 X 1 3/8	SEMI-STD
SH031020	5/16-18 X 2	100	SH037015	3/8-16 X 1 1/2	100
SH031022	5/16-18 X 2 1/4	100	SH037016	3/8-16 X 1 5/8	SEMI-STD
SH031025	5/16-18 X 2 1/2	100	SH037017	3/8-16 X 1 3/4	100
SH031027	5/16-18 X 2 3/4	100	SH037020	3/8-16 X 2	100
SH031030	5/16-18 X 3	100	SH037022	3/8-16 X 2 1/4	100
SH031032	5/16-18 X 3 1/4	100	SH037025	3/8-16 X 2 1/2	50
SH031035	5/16-18 X 3 1/2	100	SH037027	3/8-16 X 2 3/4	50
SH031037	5/16-18 X 3 3/4	SEMI-STD	SH037028	3/8-16 X 2 7/8	SEMI-STD
SH031040	5/16-18 X 4	100	SH037030	3/8-16 X 3	50
SH031045	5/16-18 X 4 1/2	SEMI-STD	SH037032	3/8-16 X 3 1/4	50
SH031050	5/16-18 X 5	SEMI-STD	SH037035	3/8-16 X 3 1/2	50
SH031055	5/16-18 X 5 1/2	SEMI-STD	SH037037	3/8-16 X 3 3/4	SEMI-STD
SH031060	5/16-18 X 6	SEMI-STD	SH037040	3/8-16 X 4	50
*****	5/16-18 X 6 1/2	SEMI-STD	SH037042	3/8-16 X 4 1/4	50
SH031070	5/16-18 X 7	SEMI-STD	SH037045	3/8-16 X 4 1/2	50

SEMI-STD DIFFÉRENTES QUANTITÉS DISPONIBLES/SEMI-STD PACKAGING ANY QUANTITY



Tel.: (819) 346-2903 / (888) 345-2903 Fax.: (819) 346-3389

Email: distributeur@boulonsestrie.com

VIS À TÊTE CYLINDRIQUE
À 6 PANS CREUX
GROS FILETS

NOIR / BARE
ALLOY STEEL

SOCKET HEAD
CAP SCREWS
NATIONAL COARSE

LA FINITION PLAQUÉE ZINC
EST DISPONIBLE
SUR DEMANDE

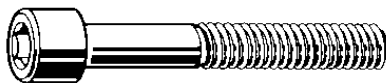

ZINC PLATED IS
AVAILABLE ON REQUEST

NOTRE CODE	DESCRIPTION	QTÉ/BTE	NOTRE CODE	DESCRIPTION	QTÉ/BTE
OUR CODE	DESCRIPTION	QTY/BOX	OUR CODE	DESCRIPTION	QTY/BOX
*****	3/8-16 X 4 3/4	SEMI-STD	SH043050	7/16-14 X 5	SEMI-STD
SH037050	3/8-16 X 5	50	*****	7/16-14 X 5 1/2	SEMI-STD
SH037055	3/8-16 X 5 1/2	SEMI-STD	SH043060	7/16-14 X 6	SEMI-STD
SH037060	3/8-16 X 6	50	*****	1/2-13 X 3/8	SEMI-STD
SH037065	3/8-16 X 6 1/2	SEMI-STD	SH050005	1/2-13 X 1/2	50
SH037070	3/8 X 7	SEMI-STD	SH050006	1/2-13 X 5/8	50
SH037075	3/8-16 X 7 1/2	SEMI-STD	SH050007	1/2-13 X 3/4	50
SH037080	3/8-16 X 8	SEMI-STD	SH050008	1/2-13 X 7/8	50
*****	3/8-16 X 9	SEMI-STD	SH050010	1/2-13 X 1	50
SH037100	3/8-16 X 10	SEMI-STD	*****	1/2-13 X 1 1/8	SEMI-STD
SH043005	7/16-14 X 1/2	100	SH050012	1/2-13 X 1 1/4	50
SH043006	7/16-14 X 5/8	100	*****	1/2-13 X 1 3/8	SEMI-STD
SH043007	7/16-14 X 3/4	100	SH050015	1/2-13 X 1 1/2	50
SH043008	7/16-14 X 7/8	100	*****	1/2-13 X 1 5/8	SEMI-STD
SH043010	7/16-14 X 1	100	SH050017	1/2-13 X 1 3/4	50
SH043012	7/16-14 X 1 1/4	100	SH050020	1/2-13 X 2	50
SH043015	7/16-14 X 1 1/2	100	SH050022	1/2-13 X 2 1/4	50
SH043017	7/16-14 X 1 3/4	100	SH050025	1/2-13 X 2 1/2	50
SH043020	7/16-14 X 2	50	SH050027	1/2-13 X 2 3/4	50
SH043022	7/16-14 X 2 1/4	50	SH050030	1/2-13 X 3	50
SH043025	7/16-14 X 2 1/2	50	SH050032	1/2-13 X 3 1/4	25
SH043027	7/16-14 X 2 3/4	50	SH050035	1/2-13 X 3 1/2	25
SH043030	7/16-14 X 3	50	SH050037	1/2-13 X 3 3/4	SEMI-STD
SH043032	7/16-14 X 3 1/4	50	SH050040	1/2-13 X 4	25
SH043035	7/16-40 X 3 1/2	50	SH050042	1/2-13 X 4 1/4	SEMI-STD
SH043040	7/16-14 X 4	50	SH050045	1/2-13 X 4 1/2	25
SH043045	7/16-14 X 4 1/2	SEMI-STD	SH050047	1/2-13 X 4 3/4	SEMI-STD

SEMI-STD DIFFÉRENTES QUANTITÉS DISPONIBLES/SEMI-STD PACKAGING ANY QUANTITY



Tel.: (819) 346-2903 / (888) 345-2903 Fax.: (819) 346-3389

Email: distributeur@boulonsestrie.com

VIS À TÊTE CYLINDRIQUE
À 6 PANS CREUX
GROS FILETS

NOIR / BARE
ALLOY STEEL

SOCKET HEAD
CAP SCREWS
NATIONAL COARSE

LA FINITION PLAQUÉE ZINC
EST DISPONIBLE
SUR DEMANDE

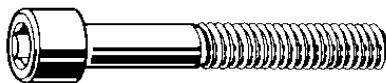

ZINC PLATED IS
AVAILABLE ON REQUEST

NOTRE CODE	DESCRIPTION	QTÉ/BTE	NOTRE CODE	DESCRIPTION	QTÉ/BTE
OUR CODE	DESCRIPTION	QTY/BOX	OUR CODE	DESCRIPTION	QTY/BOX
SH050050	1/2-13 X 5	25	*****	9/16-12 X 4	SEMI-STD
SH050052	1/2-13 X 5 1/4	SEMI-STD	*****	9/16-12 X 4 1/2	SEMI-STD
SH050055	1/2-13 X 5 1/2	25	*****	9/16-12 X 5	SEMI-STD
SH050060	1/2-13 X 6	25	*****	9/16-12 X 5 1/2	SEMI-STD
SH050065	1/2-13 X 6 1/2	10	*****	9/16-12 X 6	SEMI-STD
SH050070	1/2-13 X 7	10	*****	9/16-12 X 6 1/2	SEMI-STD
SH050075	1/2-13 X 7 1/2	SEMI-STD	*****	9/16-12 X 7	SEMI-STD
SH050080	1/2-13 X 8	10	*****	9/16-12 X 7 1/2	SEMI-STD
SH050085	1/2-13 X 8 1/2	SEMI-STD	*****	9/16-12 X 8	SEMI-STD
SH050090	1/2-13 X 9	SEMI-STD	SH062006	5/8-11 X 5/8	SEMI-STD
*****	1/2-13 X 9 1/2	SEMI-STD	*****	5/8-11 X 3/4	SEMI-STD
SH050100	1/2-13 X 10	SEMI-STD	*****	5/8-11 X 7/8	SEMI-STD
SH050110	1/2-13 X 11	SEMI-STD	SH062010	5/8-11 X 1	50
SH050120	1/2-13 X 12	SEMI-STD	SH062012	5/8-11 X 1 1/4	50
*****	1/2-13 X 14	SEMI-STD	*****	5/8-11 X 1 3/8	SEMI-STD
*****	1/2-13 X 15	SEMI-STD	SH062015	5/8-11 X 1 1/2	50
*****	1/2-13 X 16	SEMI-STD	SH062017	5/8-11 X 1 3/4	SEMI-STD
*****	9/16-12 X 1	SEMI-STD	SH062020	5/8-11 X 2	50
SH056012	9/16-12 X 1 1/4	SEMI-STD	SH062022	5/8-11 X 2 1/4	25
SH056015	9/16-12 X 1 1/2	SEMI-STD	SH062025	5/8-11 X 2 1/2	25
SH056017	9/16-12 X 1 3/4	SEMI-STD	SH062027	5/8-11 X 2 3/4	25
*****	9/16-12 X 2	SEMI-STD	SH062030	5/8-11 X 3	25
*****	9/16-12 X 2 1/4	SEMI-STD	SH062032	5/8-11 X 3 1/4	25
*****	9/16-12 X 2 1/2	SEMI-STD	SH062035	5/8-11 X 3 1/2	25
*****	9/16-12 X 2 3/4	SEMI-STD	SH062037	5/8-11 X 3 3/4	25
*****	9/16-12 X 3	SEMI-STD	SH062040	5/8-11 X 4	25
*****	9/16-12 X 3 1/2	SEMI-STD	SH062042	5/8-11 X 4 1/4	SEMI-STD

SEMI-STD DIFFÉRENTES QUANTITÉS DISPONIBLES/SEMI-STD PACKAGING ANY QUANTITY



Tel.: (819) 346-2903 / (888) 345-2903 Fax.: (819) 346-3389

Email: distributeur@boulonsestrie.com

B-6

VIS À TÊTE CYLINDRIQUE
À 6 PANS CREUX
GROS FILETS

NOIR / BARE
ALLOY STEEL

SOCKET HEAD
CAP SCREWS
NATIONAL COARSE

LA FINITION PLAQUÉE ZINC
EST DISPONIBLE
SUR DEMANDE

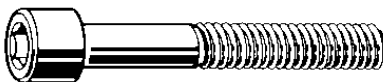

ZINC PLATED IS
AVAILABLE ON REQUEST

NOTRE CODE	DESCRIPTION	QTÉ/BTE	NOTRE CODE	DESCRIPTION	QTÉ/BTE
OUR CODE	DESCRIPTION	QTY/BOX	OUR CODE	DESCRIPTION	QTY/BOX
SH062045	5/8-11 X 4 1/2	25	SH075035	3/4-10 X 3 1/2	25
SH062050	5/8-11 X 5	25	SH075037	3/4-10 X 3 3/4	SEMI-STD
SH062055	5/8-11 X 5 1/2	10	SH075040	3/4-10 X 4	25
SH062060	5/8-11 X 6	10	*****	3/4-10 X 4 1/4	SEMI-STD
SH062065	5/8-11 X 6 1/2	10	SH075045	3/4-10 X 4 1/2	25
SH062070	5/8-11 X 7	10	*****	3/4-10 X 4 3/4	SEMI-STD
*****	5/8-11 X 7 1/2	SEMI-STD	SH075050	3/4-10 X 5	25
SH062080	5/8-11 X 8	10	SH075055	3/4-10 X 5 1/2	10
*****	5/8-11 X 8 1/2	SEMI-STD	SH075060	3/4-10 X 6	10
*****	5/8-11 X 9	SEMI-STD	SH075065	3/4-10 X 6 1/2	10
*****	5/8-11 X 9 1/2	SEMI-STD	SH075070	3/4-10 X 7	10
*****	5/8-11 X 10	SEMI-STD	SH075080	3/4-10 X 8	10
*****	5/8-11 X 11	SEMI-STD	*****	3/4-10 X 8 1/2	SEMI-STD
SH062120	5/8-11 X 12	SEMI-STD	SH075090	3/4-10 X 9	10
*****	5/8-11 X 14	SEMI-STD	*****	3/4-10 X 10	SEMI-STD
*****	5/8-11 X 15	SEMI-STD	*****	3/4-10 X 11	SEMI-STD
*****	5/8-11 X 16	SEMI-STD	*****	3/4-10 X 12	SEMI-STD
SH075010	3/4-10 X 1	SEMI-STD	*****	3/4-10 X 13	SEMI-STD
SH075012	3/4-10 X 1 1/4	25	*****	3/4-10 X 14	SEMI-STD
SH075015	3/4-10 X 1 1/2	25	*****	3/4-10 X 15	SEMI-STD
SH075017	3/4-10 X 1 3/4	25	*****	3/4-10 X 16	SEMI-STD
SH075020	3/4-10 X 2	25	*****	3/4-10 X 18	SEMI-STD
SH075022	3/4-10 X 2 1/4	25	*****	3/4-10 X 20	SEMI-STD
SH075025	3/4-10 X 2 1/2	25	*****	7/8-9 X 1 1/4	SEMI-STD
SH075027	3/4-10 X 2 3/4	25	*****	7/8-9 X 1 1/2	SEMI-STD
SH075030	3/4-10 X 3	25	*****	7/8-9 X 1 3/4	SEMI-STD
SH075032	3/4-10 X 3 1/4	25	SH087020	7/8-9 X 2	10

SEMI-STD DIFFÉRENTES QUANTITÉS DISPONIBLES/SEMI-STD PACKAGING ANY QUANTITY



Tel.: (819) 346-2903 / (888) 345-2903 Fax.: (819) 346-3389

Email: distributeur@boulonsestrie.com

B-7

VIS À TÊTE CYLINDRIQUE
À 6 PANS CREUX
GROS FILETS

NOIR / BARE
ALLOY STEEL

SOCKET HEAD
CAP SCREWS
NATIONAL COARSE

LA FINITION PLAQUÉE ZINC
EST DISPONIBLE
SUR DEMANDE

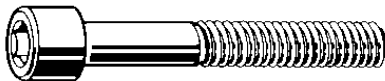

ZINC PLATED IS
AVAILABLE ON REQUEST

NOTRE CODE	DESCRIPTION	QTÉ/BTE	NOTRE CODE	DESCRIPTION	QTÉ/BTE
OUR CODE	DESCRIPTION	QTY/BOX	OUR CODE	DESCRIPTION	QTY/BOX
SH087022	7/8-9 X 2 1/4	10	SH090022	1-8 X 2 1/4	10
SH087025	7/8-9 X 2 1/2	10	SH090025	1-8 X 2 1/2	10
*****	7/8-9 X 2 3/4	SEMI-STD	SH090027	1-8 X 2 3/4	10
SH087030	7/8-9 X 3	10	SH090030	1-8 X 3	10
*****	7/8-9 X 3 1/4	SEMI-STD	*****	1-8 X 3 1/4	10
SH087035	7/8-9 X 3 1/2	10	SH090035	1-8 X 3 1/2	10
SH087040	7/8-9 X 4	10	SH090037	1-8 X 3 3/4	SEMI-STD
SH087045	7/8-9 X 4 1/2	10	SH090040	1-8 X 4	10
*****	7/8-9 X 4 3/4	SEMI-STD	*****	1-8 X 4 1/4	SEMI-STD
SH087050	7/8-9 X 5	10	SH090045	1-8 X 4 1/2	10
SH087055	7/8-9 X 5 1/2	10	*****	1-8 X 4 3/4	SEMI-STD
SH087060	7/8-9 X 6	10	SH090050	1-8 X 5	10
SH087065	7/8-9 X 6 1/2	10	SH090055	1-8 X 5 1/2	10
*****	7/8-9 X 7	10	SH090060	1-8 X 6	10
*****	7/8-9 X 7 1/2	SEMI-STD	SH090065	1-8 X 6 1/2	10
SH087080	7/8-9 X 8	10	SH090070	1-8 X 7	10
*****	7/8-9 X 9	SEMI-STD	*****	1-8 X 7 1/2	SEMI-STD
*****	7/8-9 X 10	SEMI-STD	*****	1-8 X 8	10
*****	7/8-9 X 11	SEMI-STD	*****	1-8 X 8 1/2	SEMI-STD
*****	7/8-9 X 12	SEMI-STD	*****	1-8 X 9	SEMI-STD
*****	7/8-9 X 14	SEMI-STD	*****	1-8 X 9 1/2	SEMI-STD
*****	7/8-9 X 16	SEMI-STD	*****	1-8 X 10	SEMI-STD
*****	7/8-9 X 18	SEMI-STD	*****	1-8 X 10 1/2	SEMI-STD
*****	7/8-9 X 20	SEMI-STD	*****	1-8 X 11	SEMI-STD
SH090015	1-8 X 1 1/2	SEMI-STD	*****	1-8 X 12	SEMI-STD
*****	1-8 X 1 3/4	SEMI-STD	*****	1-8 X 13	SEMI-STD
SH090020	1-8 X 2	10	*****	1-8 X 14	SEMI-STD

SEMI-STD DIFFÉRENTES QUANTITÉS DISPONIBLES/SEMI-STD PACKAGING ANY QUANTITY



Tel.: (819) 346-2903 / (888) 345-2903 Fax.: (819) 346-3389

Email: distributeur@boulonsestrie.com

VIS À TÊTE CYLINDRIQUE
À 6 PANS CREUX
GROS FILETS

NOIR / BARE
ALLOY STEEL

SOCKET HEAD
CAP SCREWS
NATIONAL COARSE

LA FINITION PLAQUÉE ZINC
EST DISPONIBLE
SUR DEMANDE

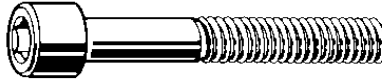

ZINC PLATED IS
AVAILABLE ON REQUEST

NOTRE CODE	DESCRIPTION	QTÉ/BTE	NOTRE CODE	DESCRIPTION	QTÉ/BTE
OUR CODE	DESCRIPTION	QTY/BOX	OUR CODE	DESCRIPTION	QTY/BOX
*****	1-8 X 16	SEMI-STD	SH092035	1 1/4-7 X 3 1/2	1
*****	1-8 X 18	SEMI-STD	*****	1 1/4-7 X 3 3/4	SEMI-STD
*****	1-8 X 20	SEMI-STD	SH092040	1 1/4-7 X 4	1
*****	1 1/8-7 X 2	SEMI-STD	SH092045	1 1/4-7 X 4 1/2	1
*****	1 1/8-7 X 2 1/2	SEMI-STD	*****	1 1/4-7 X 5	1
*****	1 1/8-7 X 3	SEMI-STD	SH092055	1 1/4-7 X 5 1/2	1
SH091035	1 1/8-7 X 3 1/2	SEMI-STD	*****	1 1/4-7 X 6	1
SH091040	1 1/8-7 X 4	SEMI-STD	*****	1 1/4-7 X 6 1/2	1
*****	1 1/8-7 X 4 1/2	SEMI-STD	*****	1 1/4-7 X 7	1
SH091050	1 1/8-7 X 5	SEMI-STD	*****	1 1/4-7 X 8	1
*****	1 1/8-7 X 5 1/2	SEMI-STD	*****	1 1/4-7 X 9	1
*****	1 1/8-7 X 6	SEMI-STD	*****	1 1/4-7 X 10	1
*****	1 1/8-7 X 7	SEMI-STD	*****	1 1/4-7 X 11	SEMI-STD
*****	1 1/8-7 X 8	SEMI-STD	*****	1 1/4-7 X 12	1
*****	1 1/8-7 X 9	SEMI-STD	*****	1 1/4-7 X 13	SEMI-STD
*****	1 1/8-7 X 10	SEMI-STD	*****	1 1/4-7 X 14	SEMI-STD
*****	1 1/8-7 X 11	SEMI-STD	*****	1 1/4-7 X 15	SEMI-STD
*****	1 1/8-7 X 12	SEMI-STD	*****	1 1/4-7 X 16	SEMI-STD
*****	1 1/8-7 X 13	SEMI-STD	*****	1 1/4-7 X 18	SEMI-STD
*****	1 1/8-7 X 14	SEMI-STD	*****	1 1/4-7 X 20	SEMI-STD
*****	1 1/8-7 X 15	SEMI-STD	*****	1 3/8-6 X 3	SEMI-STD
*****	1 1/8-7 X 16	SEMI-STD	*****	1 3/8-6 X 3 1/2	SEMI-STD
*****	1 1/4-7 X 2	SEMI-STD	*****	1 3/8-6 X 4	SEMI-STD
*****	1 1/4-7 X 2 1/4	SEMI-STD	*****	1 3/8-6 X 4 1/2	SEMI-STD
SH092025	1 1/4-7 X 2 1/2	1	*****	1 3/8-6 X 5	SEMI-STD
*****	1 1/4-7 X 2 3/4	SEMI-STD	*****	1 3/8-6 X 5 1/2	SEMI-STD
SH092030	1 1/4-7 X 3	1	*****	1 3/8-6 X 6	SEMI-STD

SEMI-STD DIFFÉRENTES QUANTITÉS DISPONIBLES/SEMI-STD PACKAGING ANY QUANTITY



Tel.: (819) 346-2903 / (888) 345-2903 Fax.: (819) 346-3389

Email: distributeur@boulonstrie.com

VIS À TÊTE CYLINDRIQUE
À 6 PANS CREUX
GROS FILETS

NOIR / BARE
ALLOY STEEL

SOCKET HEAD
CAP SCREWS
NATIONAL COARSE

LA FINITION PLAQUÉE ZINC
EST DISPONIBLE
SUR DEMANDE

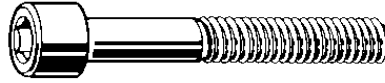

ZINC PLATED IS
AVAILABLE ON REQUEST

NOTRE CODE	DESCRIPTION	QTÉ/BTE	NOTRE CODE	DESCRIPTION	QTÉ/BTE
OUR CODE	DESCRIPTION	QTY/BOX	OUR CODE	DESCRIPTION	QTY/BOX
*****	1 3/8-6 X 7	SEMI-STD	*****	1 1/2-6 X 16	SEMI-STD
*****	1 3/8-6 X 8	SEMI-STD	*****	1 1/2-6 X 18	SEMI-STD
*****	1 3/8-6 X 10	SEMI-STD	*****	1 1/2-6 X 20	SEMI-STD
*****	1 3/8-6 X 11	SEMI-STD	*****	1 3/4-5 X 3	SEMI-STD
*****	1 3/8-6 X 12	SEMI-STD	*****	1 3/4-5 X 3 1/2	SEMI-STD
*****	1 3/8-6 X 14	SEMI-STD	*****	1 3/4-5 X 4	SEMI-STD
*****	1 3/8-6 X 16	SEMI-STD	*****	1 3/4-5 X 4 1/2	SEMI-STD
*****	1 3/8-6 X 18	SEMI-STD	*****	1 3/4-5 X 5	SEMI-STD
*****	1 3/8-6 X 20	SEMI-STD	*****	1 3/4-5 X 5 1/2	SEMI-STD
*****	1 1/2-6 X 2 1/2	SEMI-STD	*****	1 3/4-5 X 6	SEMI-STD
*****	1 1/2-6 X 2 3/4	SEMI-STD	SH097070	1 3/4-5 X 7	SEMI-STD
SH095030	1 1/2-6 X 3	1	*****	1 3/4-5 X 8	SEMI-STD
*****	1 1/2-6 X 3 1/2	1	*****	1 3/4-5 X 9	SEMI-STD
SH095040	1 1/2-6 X 4	1	*****	1 3/4-5 X 10	SEMI-STD
*****	1 1/2-6 X 4 1/2	1	*****	1 3/4-5 X 12	SEMI-STD
SH095050	1 1/2-6 X 5	1	*****	1 3/4-5 X 14	SEMI-STD
*****	1 1/2-6 X 5 1/2	1	*****	1 3/4-5 X 15	SEMI-STD
*****	1 1/2-6 X 6	1	*****	1 3/4-5 X 16	SEMI-STD
*****	1 1/2-6 X 6 1/2	1	*****	1 3/4-5 X 18	SEMI-STD
*****	1 1/2-6 X 7	1	*****	1 3/4-5 X 20	SEMI-STD
*****	1 1/2-6 X 8	1	*****	2 1/2-4 X 4	SEMI-STD
*****	1 1/2-6 X 9	1	*****	2 1/2-4 X 4 1/2	SEMI-STD
*****	1 1/2-6 X 10	1	*****	2 1/2-4 X 5	SEMI-STD
*****	1 1/2-6 X 11	SEM-STD	*****	2 1/2-4 X 5 1/2	SEMI-STD
*****	1 1/2-6 X 12	1	*****	2 1/2-4 X 6	SEMI-STD
*****	1 1/2-6 X 13	SEMI-STD	*****	2 1/2-4 X 7	SEMI-STD
*****	1 1/2-6 X 14	SEMI-STD	*****	2 1/2-4 X 8	SEMI-STD
*****	1 1/2-6 X 15	SEMI-STD	*****	...	SEMI-STD

SEMI-STD DIFFÉRENTES QUANTITÉS DISPONIBLES/SEMI-STD PACKAGING ANY QUANTITY



Tel.: (819) 346-2903 / (888) 345-2903 Fax.: (819) 346-3389

Email: distributeur@boulonstrie.com

VIS À TÊTE CYLINDRIQUE
À 6 PANS CREUX
FILETS FINS

NOIR / BARE
ALLOY STEEL

SOCKET HEAD
CAP SCREWS
NATIONAL FINE

LA FINITION PLAQUÉE ZINC
EST DISPONIBLE
SUR DEMANDE



ZINC PLATED IS
AVAILABLE ON REQUEST

NOTRE CODE	DESCRIPTION	QTÉ/BTE	NOTRE CODE	DESCRIPTION	QTÉ/BTE
OUR CODE	DESCRIPTION	QTY/BOX	OUR CODE	DESCRIPTION	QTY/BOX
*****	0-80 X 1/8	100	*****	3-56 X 5/16	SEMI-STD
*****	0-80 X 3/16	100	*****	3-56 X 3/8	SEMI-STD
*****	0-80 X 1/4	100	*****	3-56 X 1/2	SEMI-STD
*****	0-80 X 5/16	SEMI-STD	*****	3-56 X 5/8	SEMI-STD
*****	0-80 X 3/8	100	*****	3-56 X 3/4	SEMI-STD
*****	0-80 X 1/2	SEMI-STD	*****	3-56 X 1	SEMI-STD
*****	0-80 X 5/8	SEMI-STD	*****	4-48 X 1/8	SEMI-STD
*****	0-80 X 3/4	SEMI-STD	*****	4-48 X 3/16	SEMI-STD
*****	0-80 X 1	SEMI-STD	*****	4-48 X 1/4	SEMI-STD
SH101001	1-72 X 1/8	100	*****	4-48 X 5/16	SEMI-STD
*****	1-72 X 3/16	100	*****	4-48 X 3/8	SEMI-STD
*****	1-72 X 1/4	100	*****	4-48 X 7/16	SEMI-STD
*****	1-72 X 3/8	100	*****	4-48 X 1/2	SEMI-STD
*****	1-72 X 1/2	SEMI-STD	*****	4-48 X 5/8	SEMI-STD
*****	1-72 X 5/8	SEMI-STD	*****	4-48 X 3/4	SEMI-STD
SH101007	1-72 X 3/4	SEMI-STD	*****	4-48 X 7/8	SEMI-STD
*****	1-72 X 1	SEMI-STD	*****	4-48 X 1	SEMI-STD
*****	2-64 X 1/8	SEMI-STD	SH105002	5-44 X 1/4	SEMI-STD
*****	2-64 X 3/16	SEMI-STD	*****	5-44 X 3/8	SEMI-STD
*****	2-64 X 1/4	SEMI-STD	SH105005	5-44 X 1/2	SEMI-STD
*****	2-64 X 3/8	SEMI-STD	*****	5-44 X 5/8	SEMI-STD
*****	2-64 X 1/2	SEMI-STD	*****	5-44 X 3/4	SEMI-STD
*****	2-64 X 5/8	SEMI-STD	*****	6-40 X 3/16	SEMI-STD
*****	2-64 X 3/4	SEMI-STD	SH106002	6-40 X 1/4	100
*****	2-64 X 1	SEMI-STD	*****	6-40 X 5/16	SEMI-STD
*****	3-56 X 1/8	SEMI-STD	SH106004	6-40 X 3/8	100
*****	3-56 X 3/16	SEMI-STD	*****	6-40 X 7/16	SEMI-STD
*****	3-56 X 1/4	SEMI-STD	SH106005	6-40 X 1/2	100

SEMI-STD DIFFÉRENTES QUANTITÉS DISPONIBLES/SEMI-STD PACKAGING ANY QUANTITY



Tel.: (819) 346-2903 / (888) 345-2903 Fax.: (819) 346-3389
Email: distributeur@boulonstrie.com

VIS À TÊTE CYLINDRIQUE
À 6 PANS CREUX
FILETS FINS

NOIR / BARE
ALLOY STEEL

SOCKET HEAD
CAP SCREWS
NATIONAL FINE

LA FINITION PLAQUÉE ZINC
EST DISPONIBLE
SUR DEMANDE

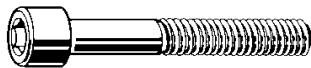

ZINC PLATED IS
AVAILABLE ON REQUEST

NOTRE CODE	DESCRIPTION	QTÉ/BTE	NOTRE CODE	DESCRIPTION	QTÉ/BTE
OUR CODE	DESCRIPTION	QTY/BOX	OUR CODE	DESCRIPTION	QTY/BOX
SH106006	6-40 X 5/8	100	*****	10-32 X 1 5/8	SEMI-STD
SH106007	6-40 X 3/4	100	SH111017	10-32 X 1 3/4	100
*****	6-40 X 7/8	SEMI-STD	SH111020	10-32 X 2	100
*****	6-40 X 1	SEMI-STD	SH111022	10-32 X 2 1/4	100
*****	8-36 X 1/4	SEMI-STD	*****	10-32 X 2 3/8	SEMI-STD
*****	8-36 X 3/8	100	SH111025	10-32 X 2 1/2	SEMI-STD
SH108005	8-36 X 1/2	100	SH111027	10-32 X 2 3/4	SEMI-STD
*****	8-36 X 5/8	SEMI-STD	SH111030	10-32 X 3	SEMI-STD
*****	8-36 X 3/4	100	SH111032	10-32 X 3 1/4	SEMI-STD
*****	8-36 X 7/8	SEMI-STD	SH111035	10-32 X 3 1/2	SEMI-STD
*****	8-36 X 1	SEMI-STD	SH111045	10-32 X 4 1/2	SEMI-STD
*****	8-36 X 1 1/4	SEMI-STD	*****	10-32 X 5	SEMI-STD
*****	8-36 X 1 1/2	SEMI-STD	*****	10-32 X 6	SEMI-STD
*****	10-32 X 3/16	SEMI-STD	*****	12-28 X 3/8	SEMI-STD
SH111002	10-32 X 1/4	SEMI-STD	*****	12-28 X 1/2	SEMI-STD
*****	10-32 X 5/16	SEMI-STD	*****	12-28 X 5/8	SEMI-STD
SH111004	10-32 X 3/8	100	*****	12-28 X 3/4	SEMI-STD
*****	10-32 X 7/16	SEMI-STD	*****	12-28 X 1	SEMI-STD
SH111005	10-32 X 1/2	100	*****	12-28 X 1 1/4	SEMI-STD
*****	10-32 X 9/16	SEMI-STD	*****	12-28 X 1 1/2	SEMI-STD
SH111006	10-32 X 5/8	100	SH125002	1/4-28 X 1/4	SEMI-STD
SH111007	10-32 X 3/4	100	SH125003	1/4-28 X 3/8	100
SH111008	10-32 X 7/8	100	*****	1/4-28 X 7/16	SEMI-STD
SH111010	10-32 X 1	100	SH125005	1/4-28 X 1/2	100
*****	10-32 X 1 1/8	SEMI-STD	*****	1/4-28 X 9/16	SEMI-STD
SH111012	10-32 X 1 1/4	100	SH125006	1/4-28 X 5/8	100
*****	10-32 X 1 3/8	SEMI-STD	SH125007	1/4-28 X 3/4	100
SH111015	10-32 X 1 1/2	SEMI-STD	SH125008	1/4-28 X 7/8	100

SEMI-STD DIFFÉRENTES QUANTITÉS DISPONIBLES/SEMI-STD PACKAGING ANY QUANTITY



Tel.: (819) 346-2903 / (888) 345-2903 Fax.: (819) 346-3389
Email: distributeur@boulonstrie.com

B-12

VIS À TÊTE CYLINDRIQUE
À 6 PANS CREUX
FILETS FINS

NOIR / BARE
ALLOY STEEL

SOCKET HEAD
CAP SCREWS
NATIONAL FINE

LA FINITION PLAQUÉE ZINC
EST DISPONIBLE
SUR DEMANDE

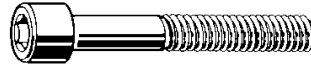

ZINC PLATED IS
AVAILABLE ON REQUEST

NOTRE CODE	DESCRIPTION	QTÉ/BTE	NOTRE CODE	DESCRIPTION	QTÉ/BTE
OUR CODE	DESCRIPTION	QTY/BOX	OUR CODE	DESCRIPTION	QTY/BOX
SH125010	1/4-28 X 1	100	*****	5/16-24 X 5	SEMI-STD
*****	1/4-28 X 1 1/8	SEMI-STD	*****	5/16-24 X 5 1/2	SEMI-STD
SH125012	1/4-28 X 1 1/4	100	*****	5/16-24 X 6	SEMI-STD
*****	1/4-28 X 1 3/8	SEMI-STD	*****	3/8-24 X 3/8	SEMI-STD
SH125015	1/4-28 X 1 1/2	100	SH137005	3/8-24 X 1/2	100
SH125017	1/4-28 X 1 3/4	100	*****	3/8-24 X 5/8	100
SH125020	1/4-28 X 2	100	SH137007	3/8-24 X 3/4	100
SH125022	1/4-28 X 2 1/4	100	*****	3/8-24 X 7/8	100
SH125025	1/4-28 X 2 1/2	SEMI-STD	SH137010	3/8-24 X 1	100
SH125035	1/4-28 X 3 1/2	100	*****	3/8-24 X 1 1/8	SEMI-STD
*****	5/16-24 X 3/8	SEMI-STD	SH137012	3/8-24 X 1 1/4	100
SH131005	5/16-24 X 1/2	100	*****	3/8-24 X 1 3/8	SEMI-STD
SH131006	5/16-24 X 5/8	100	SH137015	3/8-24 X 1 1/2	100
SH131007	5/16-24 X 3/4	100	*****	3/8-24 X 1 5/8	SEMI-STD
SH131008	5/16-24 X 7/8	100	SH137017	3/8-24 X 1 3/4	100
SH131010	5/16-24 X 1	100	SH137020	3/8-24 X 2	100
SH131012	5/16-24 X 1 1/4	100	SH137022	3/8-24 X 2 1/4	100
SH131015	5/16-24 X 1 1/2	100	SH137025	3/8-24 X 2 1/2	100
SH131017	5/16-24 X 1 3/4	100	*****	3/8-24 X 2 3/4	SEMI-STD
SH131020	5/16-24 X 2	100	SH137030	3/8-24 X 3	100
SH131022	5/16-24 X 2 1/4	100	*****	3/8-24 X 3 1/2	SEMI-STD
SH131025	5/16-24 X 2 1/2	100	*****	3/8-24 X 3 3/4	SEMI-STD
*****	5/16-24 X 2 3/4	SEMI-STD	SH137040	3/8-24 X 4	SEMI-STD
*****	5/16-24 X 3	SEMI-STD	*****	3/8-24 X 4 1/2	SEMI-STD
SH131032	5/16-24 X 3 1/4	SEMI-STD	*****	3/8-24 X 5	SEMI-STD
*****	5/16-24 X 3 1/2	SEMI-STD	*****	3/8-24 X 5 1/2	SEMI-STD
*****	5/16-24 X 4	SEMI-STD	*****	3/8-24 X 6	SEMI-STD
*****	5/16-24 X 4 1/2	SEMI-STD	*****	7/16-20 X 1/2	SEMI-STD

SEMI-STD DIFFÉRENTES QUANTITÉS DISPONIBLES/SEMI-STD PACKAGING ANY QUANTITY



Tel.: (819) 346-2903 / (888) 345-2903 Fax.: (819) 346-3389
Email: distributeur@boulonstrie.com

VIS À TÊTE CYLINDRIQUE
À 6 PANS CREUX
FILETS FINS

NOIR / BARE
ALLOY STEEL

SOCKET HEAD
CAP SCREWS
NATIONAL FINE

LA FINITION PLAQUÉE ZINC
EST DISPONIBLE
SUR DEMANDE

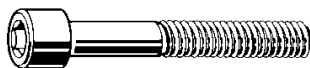

ZINC PLATED IS
AVAILABLE ON REQUEST

NOTRE CODE	DESCRIPTION	QTÉ/BTE	NOTRE CODE	DESCRIPTION	QTÉ/BTE
OUR CODE	DESCRIPTION	QTY/BOX	OUR CODE	DESCRIPTION	QTY/BOX
***** SH143007	7/16-20 X 5/8 7/16-20 X 3/4	SEMI-STD SEMI-STD	SH150025 *****	1/2-20 X 2 1/2 1/2-20 X 2 3/4	50 SEMI-STD
***** SH143010	7/16-20 X 7/8 7/16-20 X 1	SEMI-STD 100	SH150030 *****	1/2-20 X 3 1/2-20 X 3 1/4	50 SEMI-STD
SH143012	7/16-20 X 1 1/4	100	SH150035	1/2-20 X 3 1/2	SEMI-STD
SH143015	7/16-20 X 1 1/2	100	*****	1/2-20 X 3 3/4	SEMI-STD
***** SH143020	7/16-20 X 1 3/4 7/16-20 X 2	SEMI-STD 100	SH150040 *****	1/2-20 X 4 1/2-20 X 4 1/2	SEMI-STD SEMI-STD
SH143022	7/16-20 X 2 1/4	SEMI-STD	*****	1/2-20 X 5	SEMI-STD
***** SH143030	7/16-20 X 2 1/2 7/16-20 X 3	SEMI-STD SEMI-STD	***** *****	1/2-20 X 5 1/2 1/2-20 X 6	SEMI-STD SEMI-STD
***** *****	7/16-20 X 3 1/2 7/16-20 X 4	SEMI-STD SEMI-STD	***** *****	1/2-20 X 7 1/2-20 X 8	SEMI-STD SEMI-STD
***** *****	7/16-20 X 5 7/16-20 X 6	SEMI-STD SEMI-STD	***** SH156012	9/16-18 X 1 9/16-18 X 1 1/4	SEMI-STD SEMI-STD
SH150005	1/2-20 X 1/2	SEMI-STD	SH156015	9/16-18 X 1 1/2	SEMI-STD
SH150006	1/2-20 X 5/8	SEMI-STD	SH156017	9/16-18 X 1 3/4	SEMI-STD
SH150007	1/2-20 X 3/4	SEMI-STD	*****	9/16-18 X 2	SEMI-STD
*****	1/2-20 X 7/8	SEMI-STD	*****	9/16-18 X 2 1/4	SEMI-STD
SH150010	1/2-20 X 1	SEMI-STD	*****	9/16-18 X 2 1/2	SEMI-STD
*****	1/2-20 X 1 1/8	50	*****	9/16-18 X 3	SEMI-STD
SH150012	1/2-20 X 1 1/4	50	*****	9/16-18 X 4	SEMI-STD
*****	1/2-20 X 1 3/8	SEMI-STD	*****	9/16-18 X 4 1/2	SEMI-STD
SH150015	1/2-20 X 1 1/2	50	*****	9/16-18 X 5	SEMI-STD
*****	1/2-20 X 1 3/8	SEMI-STD	*****	9/16-18 X 5 1/2	SEMI-STD
SH150017	1/2-20 X 1 3/4	50	*****	9/16-18 X 6	SEMI-STD
SH150020	1/2-20 X 2	50	SH162010	5/8-18 X 1	50
SH150022	1/2-20 X 2 1/4	50	SH162012	5/8-18 X 1 1/4	50

SEMI-STD DIFFÉRENTES QUANTITÉS DISPONIBLES/SEMI-STD PACKAGING ANY QUANTITY



Tel.: (819) 346-2903 / (888) 345-2903 Fax.: (819) 346-3389
Email: distributeur@boulonstrie.com

VIS À TÊTE CYLINDRIQUE
À 6 PANS CREUX
FILETS FINS

NOIR / BARE
ALLOY STEEL

SOCKET HEAD
CAP SCREWS
NATIONAL FINE

LA FINITION PLAQUÉE ZINC
EST DISPONIBLE
SUR DEMANDE

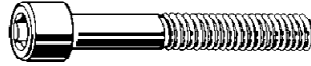

ZINC PLATED IS
AVAILABLE ON REQUEST

NOTRE CODE	DESCRIPTION	QTÉ/BTE	NOTRE CODE	DESCRIPTION	QTÉ/BTE
OUR CODE	DESCRIPTION	QTY/BOX	OUR CODE	DESCRIPTION	QTY/BOX
SH162015	5/8-18 X 1 1/2	50	*****	3/4-16 X 4 1/2	SEMI-STD
SH162017	5/8-18 X 1 3/4	50	*****	3/4-16 X 5	SEMI-STD
SH162020	5/8-18 X 2	25	*****	3/4-16 X 5 1/2	SEMI-STD
SH162022	5/8-18 X 2 1/4	SEMI-STD	*****	3/4-16 X 6	SEMI-STD
SH162025	5/8-18 X 2 1/2	25	*****	3/4-16 X 6 1/2	SEMI-STD
*****	5/8-18 X 2 3/4	SEMI-STD	*****	3/4-16 X 7	SEMI-STD
SH162030	5/8-18 X 3	SEMI-STD	*****	3/4-16 X 8	SEMI-STD
*****	5/8-18 X 3 1/4	SEMI-STD	SH187020	7/8-14 X 2	SEMI-STD
*****	5/8-18 X 3 1/2	SEMI-STD	*****	7/8-14 X 2 1/4	SEMI-STD
SH162040	5/8-18 X 4	SEMI-STD	SH187025	7/8-14 X 2 1/2	SEMI-STD
*****	5/8-18 X 4 1/2	SEMI-STD	SH187030	7/8-14 X 3	SEMI-STD
*****	5/8-18 X 5	SEMI-STD	*****	7/8-14 X 3 1/4	SEMI-STD
*****	5/8-18 X 5 1/2	SEMI-STD	*****	7/8-14 X 3 1/2	SEMI-STD
*****	5/8-18 X 6	SEMI-STD	SH187040	7/8-14 X 4	SEMI-STD
*****	5/8-18 X 6 1/2	SEMI-STD	*****	7/8-14 X 4 1/2	SEMI-STD
*****	5/8-18 X 7	SEMI-STD	*****	7/8-14 X 5	SEMI-STD
*****	5/8-18 X 8	SEMI-STD	*****	7/8-14 X 6	SEMI-STD
*****	3/4-16 X 1 1/4	SEMI-STD	*****	7/8-14 X 7	SEMI-STD
*****	3/4-16 X 1 1/2	SEMI-STD	*****	7/8-14 X 8	SEMI-STD
*****	3/4-16 X 1 3/4	SEMI-STD	*****	1-12 X 2	SEMI-STD
SH175020	3/4-16 X 2	SEMI-STD	*****	1-12 X 2 1/4	SEMI-STD
SH175022	3/4-16 X 2 1/4	SEMI-STD	*****	1-12 X 2 1/2	SEMI-STD
SH175025	3/4-16 X 2 1/2	SEMI-STD	*****	1-12 X 3	SEMI-STD
SH175027	3/4-16 X 2 3/4	SEMI-STD	*****	1-12 X 3 1/2	SEMI-STD
SH175030	3/4-16 X 3	SEMI-STD	*****	1-12 X 4	SEMI-STD
*****	3/4-16 X 3 1/4	SEMI-STD	*****	1-12 X 4 1/2	SEMI-STD
*****	3/4-16 X 3 1/2	SEMI-STD	*****	1-12 X 5	SEMI-STD
*****	3/4-16 X 4	SEMI-STD	*****	1-12 X 6	SEMI-STD

SEMI-STD DIFFÉRENTES QUANTITÉS DISPONIBLES/SEMI-STD PACKAGING ANY QUANTITY



Tel.: (819) 346-2903 / (888) 345-2903 Fax.: (819) 346-3389
Email: distributeur@boulonsestrie.com

VIS À TÊTE CYLINDRIQUE
À 6 PANS CREUX
FILETS FINS

NOIR / BARE
ALLOY STEEL

SOCKET HEAD
CAP SCREWS
NATIONAL FINE

LA FINITION PLAQUÉE ZINC
EST DISPONIBLE
SUR DEMANDE

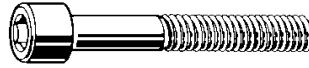

ZINC PLATED IS
AVAILABLE ON REQUEST

NOTRE CODE	DESCRIPTION	QTÉ/BTE	NOTRE CODE	DESCRIPTION	QTÉ/BTE
OUR CODE	DESCRIPTION	QTY/BOX	OUR CODE	DESCRIPTION	QTY/BOX
*****	1-12 X 7	SEMI-STD	*****	1 1/4-12 X 7	SEMI-STD
*****	1-14 X 2	SEMI-STD	*****	1 1/4-12 X 8	SEMI-STD
*****	1-14 X 2 1/4	SEMI-STD	*****	1 1/4-12 X 9	SEMI-STD
*****	1-14 X 2 1/2	SEMI-STD	*****	1 1/4-12 X 10	SEMI-STD
*****	1-14 X 2 3/4	SEMI-STD	*****	1 1/4-12 X 12	SEMI-STD
SH190030	1-14 X 3	SEMI-STD	*****	1 3/8-12 X 3	SEMI-STD
*****	1-14 X 3 1/4	SEMI-STD	*****	1 3/8-12 X 3 1/2	SEMI-STD
*****	1-14 X 3 1/2	SEMI-STD	*****	1 3/8-12 X 4	SEMI-STD
*****	1-14 X 4	SEMI-STD	*****	1 3/8-12 X 4 1/2	SEMI-STD
*****	1-14 X 4 1/2	SEMI-STD	*****	1 3/8-12 X 5	SEMI-STD
*****	1-14 X 5	SEMI-STD	*****	1 3/8-12 X 5 1/2	SEMI-STD
*****	1-14 X 5 1/2	SEMI-STD	*****	1 3/8-12 X 6	SEMI-STD
*****	1-14 X 6	SEMI-STD	*****	1 3/8-12 X 7	SEMI-STD
*****	1-14 X 7	SEMI-STD	*****	1 3/8-12 X 8	SEMI-STD
*****	1-14 X 8	SEMI-STD	*****	1 3/8-12 X 10	SEMI-STD
*****	1 1/4-12 X 2	SEMI-STD	*****	1 1/2-12 X 3	SEMI-STD
SH192025	1 1/4-12 X 2 1/2	SEMI-STD	*****	1 1/2-12 X 4	SEMI-STD
*****	1 1/4-12 X 3	SEMI-STD	*****	1 1/2-12 X 4 1/2	SEMI-STD
*****	1 1/4-12 X 3 1/2	SEMI-STD	*****	1 1/2-12 X 5	SEMI-STD
SH192040	1 1/4-12 X 4	SEMI-STD	SH195055	1 1/2-12 X 5 1/2	SEMI-STD
SH192045	1 1/4-12 X 4 1/2	SEMI-STD	*****	1 1/2-12 X 6	SEMI-STD
*****	1 1/4-12 X 5	SEMI-STD	*****	1 1/2-12 X 7	SEMI-STD
*****	1 1/4-12 X 5 1/2	SEMI-STD	*****	1 1/2-12 X 8	SEMI-STD
*****	1 1/4-12 X 6	SEMI-STD	*****	1 1/2-12 X 10	SEMI-STD
			*****	1 1/2-12 X 12	SEMI-STD

SEMI-STD DIFFÉRENTES QUANTITÉS DISPONIBLES/SEMI-STD PACKAGING ANY QUANTITY



Tel.: (819) 346-2903 / (888) 345-2903 Fax.: (819) 346-3389
Email: distributeur@boulonstrie.com

VIS À TÊTE
CYLINDRIQUE
À 6 PANS CREUX
GROS FILETS

SS-304
18-8

SOCKET HEAD
CAP SCREWS
NATIONAL COARSE

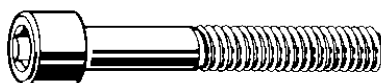

NOTRE CODE	DESCRIPTION	QTÉ/BTE	NOTRE CODE	DESCRIPTION	QTÉ/BTE
OUR CODE	DESCRIPTION	QTY/BOX	OUR CODE	DESCRIPTION	QTY/BOX
SH602005	2-56 X 1/2	100	SH608017	8-32 X 1 3/4	100
SH604002	4-40 X 1/4	100	SH610002	10-24 X 1/4	100
SH604004	4-40 X 3/8	100	SH610004	10-24 X 3/8	100
SH604005	4-40 X 1/2	100	SH610005	10-24 X 1/2	100
SH604007	4-40 X 3/4	100	SH610006	10-24 X 5/8	100
SH604010	4-40 X 1	100	SH610007	10-24 X 3/4	100
SH605002	5-40 X 1/4	100	SH610010	10-24 X 1	100
SH605005	5-40 X 1/2	100	SH610012	10-24 X 1 1/4	100
SH605007	5-40 X 3/4	100	SH610015	10-24 X 1 1/2	100
SH605020	5-40 X 2	100	SH610017	10-24 X 1 3/4	100
SH606001	6-32 X 1/8	100	SH610020	10-24 X 2	100
SH606002	6-32 X 3/16	100	SH611002	10-32 X 1/4	100
SH606003	6-32 X 1/4	100	SH611003	10-32 X 5/16	100
SH606005	6-32 X 1/2	100	SH611004	10-32 X 3/8	100
SH606007	6-32 X 3/4	100	SH611005	10-32 X 1/2	100
SH606008	6-32 X 7/8	100	SH611006	10-32 X 5/8	100
SH606015	6-32 X 1 1/2	100	SH611007	10-32 X 3/4	100
SH606020	6-32 X 2	100	SH611010	10-32 X 1	100
SH608002	8-32 X 1/4	100	SH611012	10-32 X 1 1/4	100
SH608004	8-32 X 3/8	100	SH611015	10-32 X 1 1/2	100
SH608005	8-32 X 1/2	100	SH611017	10-32 X 1 3/4	100
SH608006	8-32 X 5/8	100	SH611020	10-32 X 2	100
SH608007	8-32 X 3/4	100	SH625002	1/4-20 X 1/4	100
SH608008	8-32 X 7/8	100	SH625004	1/4-20 X 3/8	100
SH608010	8-32 X 1	100	SH625005	1/4-20 X 1/2	100
SH608015	8-32 X 1 1/2	100	SH625006	1/4-20 X 5/8	100

AUTRES DIMENSIONS DISPONIBLES/OTHER DIMENSIONS ARE AVAILABLE



Tel.: (819) 346-2903 / (888) 345-2903 Fax.: (819) 346-3389
Email: distributeur@boulonstrie.com

B-17

VIS À TÊTE
CYLINDRIQUE
À 6 PANS CREUX
GROS FILETS

SS-304
18-8

SOCKET HEAD
CAP SCREWS
NATIONAL COARSE

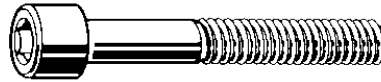

NOTRE CODE	DESCRIPTION	QTÉ/BTE	NOTRE CODE	DESCRIPTION	QTÉ/BTE
OUR CODE	DESCRIPTION	QTY/BOX	OUR CODE	DESCRIPTION	QTY/BOX
SH625007	1/4-20 X 3/4	100	SH637017	3/8-16 X 1 3/4	100
SH625010	1/4-20 X 1	100	SH637020	3/8-16 X 2	100
SH625012	1/4-20 X 1 1/4	100	SH637025	3/8-16 X 2 1/2	100
SH625015	1/4-20 X 1 1/2	100	SH637027	3/8-16 X 2 3/4	100
SH625017	1/4-20 X 1 3/4	100	SH637030	3/8-16 X 3	100
SH625020	1/4-20 X 2	100	SH637035	3/8-16 X 3 1/2	100
SH625022	1/4-20 X 2 1/4	100	SH637040	3/8-16 X 4	100
SH625025	1/4-20 X 2 1/2	100	SH650007	1/2-13 X 3/4	50
SH631005	5/16-18 X 1/2	100	SH650010	1/2-13 X 1	50
SH631006	5/16-18 X 5/8	100	SH650012	1/2-13 X 1 1/4	50
SH631007	5/16-18 X 3/4	100	SH650015	1/2-13 X 1 1/2	50
SH631008	5/16-18 X 7/8	100	SH650017	1/2-13 X 1 3/4	50
SH631010	5/16-18 X 1	100	SH650020	1/2-13 X 2	50
SH631012	5/16-18 X 1 1/4	100	SH650025	1/2-13 X 2 1/2	50
SH631015	5/16-18 X 1 1/2	100	SH650030	1/2-13 X 3	50
SH631017	5/16-18 X 1 3/4	100	SH650035	1/2-13 X 3 1/2	50
SH631020	5/16-18 X 2	100	SH650045	1/2-13 X 4 1/2	50
SH631022	5/16-18 X 2 1/4	100	SH662010	5/8-11 X 1	25
SH631030	5/16-18 X 3	100	SH662012	5/8-11 X 1 1/4	25
SH631040	5/16-18 X 4	100	SH662015	5/8-11 X 1 1/2	25
SH637005	3/8-16 X 1/2	100	SH662020	5/8-11 X 2	25
SH637006	3/8-16 X 5/8	100	SH662025	5/8-11 X 2 1/2	25
SH637007	3/8-16 X 3/4	100	SH662030	5/8-11 X 3	25
SH637010	3/8-16 X 1	100	SH662050	5/8-11 X 5	25
SH637012	3/8-16 X 1 1/4	100	SH662055	5/8-11 X 5 1/2	25
SH637015	3/8-16 X 1 1/2	100	SH662060	5/8-11 X 6	25

AUTRES DIMENSIONS DISPONIBLES/OTHER DIMENSIONS ARE AVAILABLE



Tel.: (819) 346-2903 / (888) 345-2903 Fax.: (819) 346-3389
Email: distributeur@boulonstrie.com

B-18

VIS À TÊTE
CYLINDRIQUE
À 6 PANS CREUX
GROS FILETS

SS-304
18-8

SOCKET HEAD
CAP SCREWS
NATIONAL COARSE

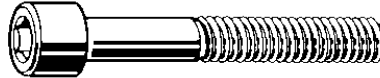

NOTRE CODE	DESCRIPTION	QTÉ/BTE	NOTRE CODE	DESCRIPTION	QTÉ/BTE
OUR CODE	DESCRIPTION	QTY/BOX	OUR CODE	DESCRIPTION	QTY/BOX
SH662067	5/8-11 X 6 3/4	25	SH687025	7/8-9 X 2 1/2	20
SH662070	5/8-11 X 7	25	SH687027	7/8-9 X 2 3/4	20
SH675010	3/4-10 X 1	25	SH687080	7/8-9 X 8	20
SH675015	3/4-10 X 1 1/2	25	SH690025	1-8 X 2 1/2	20
SH675020	3/4-10 X 2	25	SH690030	1-8 X 3	20
SH675025	3/4-10 X 2 1/2	25	SH690035	1-8 X 3 1/2	20
SH675030	3/4-10 X 3	25	SH690045	1-8 X 4 1/2	20

AUTRES DIMENSIONS DISPONIBLES/OTHER DIMENSIONS ARE AVAILABLE



Tel.: (819) 346-2903 / (888) 345-2903 Fax.: (819) 346-3389
Email: distributeur@boulonsestrie.com

B-19

VIS À TÊTE
CYLINDRIQUE
À 6 PANS CREUX
GROS FILETS

SS-316

SOCKET HEAD
CAP SCREWS
NATIONAL COARSE

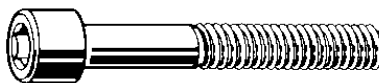

NOTRE CODE	DESCRIPTION	QTÉ/BTE	NOTRE CODE	DESCRIPTION	QTÉ/BTE
OUR CODE	DESCRIPTION	QTY/BOX	OUR CODE	DESCRIPTION	QTY/BOX
SH710005	10-24 X 1/2	100	SH750007	1/2-13 X 3/4	100
SH710006	10-24 X 5/8	100	SH750010	1/2-13 X 1	50
SH710007	10-24 X 3/4	100	SH750012	1/2-13 X 1 1/4	50
SH710010	10-24 X 1	100	SH750015	1/2-13 X 1 1/2	50
SH725005	1/4-20 X 1/2	100	SH750020	1/2-13 X 2	50
SH725007	1/4-20 X 3/4	100	SH750025	1/2-13 X 2 1/2	50
SH725010	1/4-20 X 1	100	SH750035	1/2-13 X 3 1/2	50
SH731007	5/16-18 X 3/4	100	SH750040	1/2-13 X 4	50
SH731010	5/16-18 X 1	100	SH762010	5/8-11 X 1	25
SH731012	5/16-18 X 1 1/4	100	SH762012	5/8-11 X 1 1/4	25
SH737005	3/8-16 X 1/2	100	SH762015	5/8-11 X 1 1/2	25
SH737007	3/8-16 X 3/4	100	SH762017	5/8-11 X 1 3/4	25
SH737010	3/8-16 X 1	100	SH762020	5/8-11 X 2	25
SH737012	3/8-16 X 1 1/4	100	SH775012	3/4-10 X 1 1/4	20
SH737015	3/8-16 X 1 1/2	100	SH775015	3/4-10 X 1 1/2	20
SH737017	3/8-16 X 1 3/4	100	SH775017	3/4-10 X 1 3/4	20
SH737020	3/8-16 X 2	100	*****	3/4-10 X 2	20
SH737022	3/8-16 X 2 1/4	100	SH775022	3/4-10 X 2 1/4	20

AUTRES DIMENSIONS DISPONIBLES / OTHER DIMENSIONS AVAILABLE

AUSSI DISPONIBLE / ALSO AVAILABLE

FILETS FINS / NATIONAL FINE THREADS



Tel.: (819) 346-2903 / (888) 345-2903 Fax.: (819) 346-3389

Email: distributeur@boulonstrie.com

B-20

VIS À TÊTE
CYLINDRIQUE
À 6 PANS CREUX
GROS FILETS

GRADE 12.9
MÉTRIQUE / METRIC DIN 912

SOCKET HEAD
CAP SCREWS
NATIONAL COARSE

NOIR / BARE

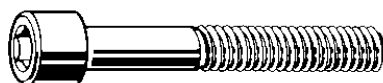

NOTRE CODE	DESCRIPTION	QTÉ/BTE	NOTRE CODE	DESCRIPTION	QTÉ/BTE
OUR CODE	DESCRIPTION	QTY/BOX	OUR CODE	DESCRIPTION	QTY/BOX
*****	M1.6 X .35 X 3	100	SH303020	M3 X .50 X 20	100
*****	M1.6 X .35 X 4	100	SH303025	M3 X .50 X 25	100
*****	M1.6 X .35 X 5	100	SH303030	M3 X .50 X 30	100
*****	M1.6 X .35 X 6	100	SH303035	M3 X .50 X 35	100
*****	M2 X .40 X 3	100	SH303040	M3 X .50 X 40	100
*****	M2 X .40 X 4	100	*****	M3 X .50 X 45	100
*****	M2 X .40 X 5	100	SH303050	M3 X .50 X 50	100
SH302006	M2 X .40 X 6	100	*****	M4 X .70 X 5	100
*****	M2 X .40 X 8	100	SH304006	M4 X .70 X 6	100
SH302010	M2 X .40 X 10	100	SH304008	M4 X .70 X 8	100
SH302012	M2 X .40 X 12	100	SH304010	M4 X .70 X 10	100
*****	M2 X .40 X 16	100	SH304012	M4 X .70 X 12	100
*****	M2.5 X .45 X 4	100	SH304014	M4 X .70 X 14	100
SH302505	M2.5 X .45 X 5	100	SH304016	M4 X .70 X 16	100
SH302506	M2.5X .45 X 6	100	SH304018	M4 X .70 X 18	100
SH302508	M2.5X .45 X 8	100	SH304020	M4 X .70 X 20	100
*****	M2.5X .45 X 10	100	SH304025	M4 X .70 X 25	100
SH302512	M2.5X .45 X 12	100	SH304030	M4 X .70 X 30	100
SH302516	M2.5X .45 X 16	100	SH304035	M4 X .70 X 35	100
SH303005	M3 X .50 X 5	100	SH304040	M4 X .70 X 40	100
SH303006	M3 X .50 X 6	100	SH304045	M4 X .70 X 45	100
SH303008	M3 X .50 X 8	100	SH304050	M4 X .70 X 50	100
SH303010	M3 X .50 X 10	100	SH304055	M4 X .70 X 55	100
SH303012	M3 X .50 X 12	100	SH304060	M4 X .70 X 60	100
*****	M3 X .50 X 14	100	SH304070	M4 X .70 X 70	100
SH303016	M3 X .50 X 16	100	SH305006	M5 X .80 X 6	100

AUTRES DIMENSIONS DISPONIBLES /OTHER DIMENSIONS AVAILABLE



Tel.: (819) 346-2903 / (888) 345-2903 Fax.: (819) 346-3389

Email: distributeur@boulonstrie.com

B-21

VIS À TÊTE
CYLINDRIQUE
À 6 PANS CREUX
GROS FILETS

GRADE 12.9
MÉTRIQUE / METRIC DIN 912

SOCKET HEAD
CAP SCREWS
NATIONAL COARSE

NOIR / BARE

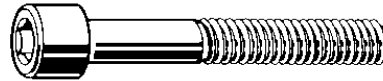

NOTRE CODE	DESCRIPTION	QTÉ/BTE	NOTRE CODE	DESCRIPTION	QTÉ/BTE
OUR CODE	DESCRIPTION	QTY/BOX	OUR CODE	DESCRIPTION	QTY/BOX
SH305008	M5 X .80 X 8	100	*****	M6 X 1.00 X 15	100
SH305010	M5 X .80 X 10	100	SH306016	M6 X 1.00 X 16	100
SH305012	M5 X .80 X 12	100	SH306018	M6 X 1.00 X 18	100
*****	M5 X .80 X 14	100	SH306020	M6 X 1.00 X 20	100
*****	M5 X .80 X 15	100	*****	M6 X 1.00 X 22	100
SH305016	M5 X .80 X 16	100	SH306025	M6 X 1.00 X 25	100
*****	M5 X .80 X 18	100	SH306030	M6 X 1.00 X 30	100
SH305020	M5 X .80 X 20	100	SH306035	M6 X 1.00 X 35	100
*****	M5 X .80 X 22	100	SH306040	M6 X 1.00 X 40	100
SH305025	M5 X .80 X 25	100	SH306045	M6 X 1.00 X 45	100
SH305030	M5 X .80 X 30	100	SH306050	M6 X 1.00 X 50	100
SH305035	M5 X .80 X 35	100	SH306055	M6 X 1.00 X 55	100
SH305040	M5 X .80 X 40	100	SH306060	M6 X 1.00 X 60	100
SH305045	M5 X .80 X 45	100	SH306065	M6 X 1.00 X 65	100
SH305050	M5 X .80 X 50	100	SH306070	M6 X 1.00 X 70	100
SH305055	M5 X .80 X 55	100	SH306075	M6 X 1.00 X 75	100
SH305060	M5 X .80 X 60	100	SH306080	M6 X 1.00 X 80	100
SH305065	M5 X .80 X 65	100	SH306090	M6 X 1.00 X 90	100
SH305070	M5 X .80 X 70	100	SH306100	M6 X 1.00 X 100	100
SH305075	M5 X .80 X 75	100	*****	M6 X 1.00 X 110	100
SH305080	M5 X .80 X 80	100	SH306120	M6 X 1.00 X 120	100
SH305115	M5 X .80 X 115	100	SH308010	M8 X 1.25 X 10	100
SH306008	M6 X 1.00 X 8	100	SH308012	M8 X 1.25 X 12	100
SH306010	M6 X 1.00 X 10	100	*****	M8 X 1.25 X 14	100
SH306012	M6 X 1.00 X 12	100	SH308016	M8 X 1.25 X 16	100
*****	M6 X 1.00 X 14	100	SH308018	M8 X 1.25 X 18	100

AUTRES DIMENSIONS DISPONIBLES / OTHER DIMENSIONS AVAILABLE



Tel.: (819) 346-2903 / (888) 345-2903 Fax.: (819) 346-3389

Email: distributeur@boulonstrie.com

B-22

VIS À TÊTE
CYLINDRIQUE
À 6 PANS CREUX
GROS FILETS

GRADE 12.9
MÉTRIQUE / METRIC DIN 912

SOCKET HEAD
CAP SCREWS
NATIONAL COARSE

NOIR / BARE

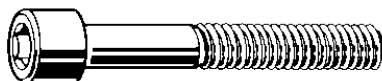

NOTRE CODE	DESCRIPTION	QTÉ/BTE	NOTRE CODE	DESCRIPTION	QTÉ/BTE
OUR CODE	DESCRIPTION	QTY/BOX	OUR CODE	DESCRIPTION	QTY/BOX
SH308020	M8 X 1.25 X 20	100	*****	M10 X 1.25 X 15	100
*****	M8 X 1.25 X 22	100	*****	M10 X 1.25 X 16	100
SH308025	M8 X 1.25 X 25	100	*****	M10 X 1.25 X 18	100
SH308030	M8 X 1.25 X 30	100	*****	M10 X 1.25 X 20	100
SH308035	M8 X 1.25 X 35	100	*****	M10 X 1.25 X 22	100
SH308040	M8 X 1.25 X 40	100	SH310012	M10 X 1.50 X 12	100
SH308045	M8 X 1.25 X 45	100	SH310015	M10 X 1.50 X 15	100
SH308050	M8 X 1.25 X 50	100	SH310016	M10 X 1.50 X 16	100
SH308055	M8 X 1.25 X 55	100	SH310020	M10 X 1.50 X 20	100
SH308060	M8 X 1.25 X 60	100	SH310025	M10 X 1.50 X 25	100
SH308065	M8 X 1.25 X 65	100	SH310030	M10 X 1.50 X 30	100
SH308070	M8 X 1.25 X 70	100	SH310035	M10 X 1.50 X 35	100
SH308075	M8 X 1.25 X 75	100	SH310040	M10 X 1.50 X 40	100
SH308080	M8 X 1.25 X 80	100	SH310045	M10 X 1.50 X 45	50
SH308090	M8 X 1.25 X 90	100	SH310050	M10 X 1.50 X 50	50
SH308100	M8 X 1.25 X 100	100	SH310055	M10 X 1.50 X 55	50
SH308110	M8 X 1.25 X 110	100	SH310060	M10 X 1.50 X 60	50
SH308120	M8 X 1.25 X 120	100	SH310065	M10 X 1.50 X 65	50
SH308130	M8 X 1.25 X 130	100	SH310070	M10 X 1.50 X 70	50
SH308140	M8 X 1.25 X 140	100	SH310075	M10 X 1.50 X 75	50
*****	M8 X 1.25 X 150	100	SH310080	M10 X 1.50 X 80	50
SH308160	M8 X 1.25 X 160	100	SH310090	M10 X 1.50 X 90	50
*****	M8 X 1.25 X 180	100	SH310100	M10 X 1.50 X 100	50
*****	M8 X 1.25 X 200	100	*****	M10 X 1.50 X 110	50
*****	M10 X 1.25 X 12	100	SH310120	M10 X 1.50 X 120	50
*****	M10 X 1.25 X 14	100	*****	M10 X 1.50 X 130	50

AUTRES DIMENSIONS DISPONIBLES / OTHER DIMENSIONS AVAILABLE



Tel.: (819) 346-2903 / (888) 345-2903 Fax.: (819) 346-3389

Email: distributeur@boulonstrie.com

B-23

VIS À TÊTE
CYLINDRIQUE
À 6 PANS CREUX
GROS FILETS

GRADE 12.9
MÉTRIQUE / METRIC DIN 912

SOCKET HEAD
CAP SCREWS
NATIONAL COARSE

NOIR / BARE

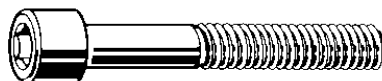

NOTRE CODE	DESCRIPTION	QTÉ/BTE	NOTRE CODE	DESCRIPTION	QTÉ/BTE
OUR CODE	DESCRIPTION	QTY/BOX	OUR CODE	DESCRIPTION	QTY/BOX
*****	M10 X 1.50 X 140	50	SH312140	M12 X 1.75 X 140	25
SH310150	M10 X 1.50 X 150	50	*****	M12 X 1.75X 150	25
SH310160	M10 X 1.50 X 160	25	SH312160	M12 X 1.75 X 160	10
SH310180	M10 X 1.50 X 180	25	*****	M12X 1.75 X 180	10
*****	M10 X 1.50 X 200	25	SH312200	M12 X 1.75 X 200	10
*****	M12 X 1.75X 12	50	SH314030	M14 X 2.00 X 30	50
SH312016	M12 X 1.75 X 16	50	SH314035	M14 X 2.00 X 35	50
*****	M12X 1.75 X 18	50	SH314040	M14 X 2.00 X 40	50
SH312020	M12 X 1.75 X 20	50	*****	M14 X 2.00 X 45	50
SH312025	M12 X 1.75 X 25	50	SH314050	M14 X 2.00 X 50	50
SH312030	M12 X 1.75 X 30	50	SH314055	M14 X 2.00 X 55	50
SH312035	M12 X 1.75 X 35	50	SH314060	M14 X 2.00 X 60	25
SH312040	M12 X 1.75 X 40	50	SH314070	M14 X 2.00 X 70	25
SH312045	M12 X 1.75 X 45	50	SH314080	M14 X 2.00 X 80	25
SH312050	M12 X 1.75 X 50	50	*****	M14 X 2.00 X 90	25
SH312055	M12 X 1.75 X 55	50	*****	M14X 2.00 X 100	25
SH312060	M12 X 1.75 X 60	50	*****	M14X 2.00 X 110	25
SH312065	M12 X 1.75 X 65	50	SH314120	M14 X 2.00 X 120	25
SH312070	M12 X 1.75 X 70	25	*****	M14 X 2.00 X 130	25
SH312075	M12 X 1.75 X 75	25	SH316020	M16 X 2.00 X 20	25
SH312080	M12 X 1.75 X 80	25	SH316025	M16 X 2.00 X 25	25
SH312090	M12 X 1.75 X 90	25	SH316030	M16 X 2.00 X 30	25
SH312100	M12 X 1.75 X 100	25	SH316035	M16 X 2.00 X 35	25
SH312110	M12 X 1.75 X 110	25	SH316040	M16 X 2.00 X40	25
SH312120	M12 X 1.75 X 120	25	SH316045	M16 X 2.00 X 45	25
*****	M12X 1.75 X 130	25	SH316050	M16 X 2.00 X 50	25

AUTRES DIMENSIONS DISPONIBLES /OTHER DIMENSIONS AVAILABLE



Tel.: (819) 346-2903 / (888) 345-2903 Fax.: (819) 346-3389

Email: distributeur@boulonstrie.com

B-24

VIS À TÊTE
CYLINDRIQUE
À 6 PANS CREUX
GROS FILETS

GRADE 12.9
MÉTRIQUE / METRIC DIN 912

SOCKET HEAD
CAP SCREWS
NATIONAL COARSE

NOIR / BARE

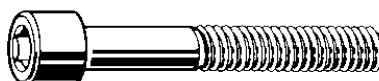

NOTRE CODE	DESCRIPTION	QTÉ/BTE	NOTRE CODE	DESCRIPTION	QTÉ/BTE
OUR CODE	DESCRIPTION	QTY/BOX	OUR CODE	DESCRIPTION	QTY/BOX
SH316055	M16 X 2.00 X 55	25	*****	M18 X 2.50 X 75	25
SH316060	M16 X 2.00 X 60	25	SH318080	M18 X 2.50 X 80	25
SH316065	M16 X 2.00 X 65	25	*****	M18 X 2.50 X 90	25
SH316070	M16 X 2.00 X 70	25	SH318100	M18 X 2.50 X 100	10
SH316075	M16 X 2.00 X 75	25	*****	M18 X 2.50 X 110	10
SH316080	M16 X 2.00 X 80	25	*****	M18 X 2.50 X 120	10
SH316090	M16 X 2.00 X 90	25	*****	M18 X 2.50 X 130	10
SH316100	M16 X 2.00 X 100	25	*****	M18 X 2.50 X 140	10
SH316110	M16 X 2.00 X 110	25	*****	M18 X 2.50 X 150	10
SH316120	M16 X 2.00 X 120	25	*****	M18 X 2.50 X 160	10
SH316130	M16 X 2.00 X 130	25	*****	M18 X 2.50 X 180	10
SH316140	M16 X 2.00 X 140	10	*****	M18 X 2.50 X 200	10
SH316150	M16 X 2.00 X 150	10	*****	M20 X 2.50 X 35	25
SH316160	M16 X 2.00 X 160	10	SH320040	M20 X 2.50 X 40	25
SH316180	M16 X 2.00 X 180	10	SH320045	M20 X 2.50 X 45	25
SH316200	M16 X 2.00 X 200	10	SH320050	M20 X 2.50 X 50	25
SH316220	M16 X 2.00 X 220	10	SH320055	M20 X 2.50 X 55	25
*****	M18 X 2.50 X 30	25	SH320060	M20 X 2.50 X 60	25
*****	M18 X 2.50 X 35	25	SH320065	M20 X 2.50 X 65	25
*****	M18 X 2.50 X 40	25	SH320070	M20 X 2.50 X 70	25
*****	M18 X 2.50 X 45	25	*****	M20 X 2.50 X 75	25
*****	M18 X 2.50 X 50	25	SH320080	M20 X 2.50 X 80	25
SH318055	M18 X 2.50 X 55	25	SH320090	M20 X 2.50 X 90	25
*****	M18 X 2.50 X 60	25	SH320100	M20 X 2.50 X 100	25
*****	M18 X 2.50 X 65	25	SH320110	M20 X 2.50 X 110	25
*****	M18 X 2.50 X 70	25	SH320120	M20 X 2.50 X 120	25

AUTRES DIMENSIONS DISPONIBLES / OTHER DIMENSIONS AVAILABLE



Tel.: (819) 346-2903 / (888) 345-2903 Fax.: (819) 346-3389

Email: distributeur@boulonstrie.com

B-25

VIS À TÊTE
CYLINDRIQUE
À 6 PANS CREUX
GROS FILETS

GRADE 12.9
MÉTRIQUE / METRIC DIN 912

SOCKET HEAD
CAP SCREWS
NATIONAL COARSE

NOIR / BARE

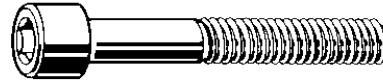

NOTRE CODE	DESCRIPTION	QTÉ/BTE	NOTRE CODE	DESCRIPTION	QTÉ/BTE
OUR CODE	DESCRIPTION	QTY/BOX	OUR CODE	DESCRIPTION	QTY/BOX
SH320130	M20 X 2.50 X 130	10	*****	M22 X 2.50 X 130	10
*****	M20 X 2.50 X 140	10	*****	M22 X 2.50 X 140	10
SH320150	M20 X 2.50 X 150	10	*****	M22 X 2.50 X 150	10
SH320160	M20 X 2.50 X 160	10	*****	M22 X 2.50 X 160	10
SH320180	M20 X 2.50 X 180	10	*****	M22 X 2.50 X 180	10
SH320200	M20 X 2.50 X 200	10	*****	M22 X 2.50 X 200	10
*****	M20 X 2.50 X 220	5	SH324050	M24 X 3.00 X 50	10
*****	M20 X 2.50 X 240	5	SH324055	M24 X 3.00 X 55	10
*****	M20 X 2.50 X 260	5	SH324060	M24 X 3.00 X 60	10
*****	M20 X 2.50 X 280	5	*****	M24 X 3.00 X 65	10
*****	M20 X 2.50 X 300	5	SH324070	M24 X 3.00 X 70	10
*****	M20 X 2.50 X 320	1	*****	M24 X 3.00 X 75	10
*****	M20 X 2.50 X 340	1	*****	M24 X 3.00 X 80	10
*****	M22 X 2.50 X 40	10	*****	M24 X 3.00 X 90	10
*****	M22 X 2.50 X 45	10	*****	M24 X 3.00 X 100	**
*****	M22 X 2.50 X 50	10	*****	M24 X 3.00 X 110	**
*****	M22 X 2.50 X 55	10	SH324120	M24 X 3.00 X 120	10
*****	M22 X 2.50 X 60	10	SH324130	M24 X 3.00 X 130	10
*****	M22 X 2.50 X 65	10	*****	M24 X 3.00 X 140	10
*****	M22 X 2.50 X 70	10	*****	M24 X 3.00 X 150	10
*****	M22 X 2.50 X 75	10	*****	M24 X 3.00 X 160	10
*****	M22 X 2.50 X 80	10	SH324180	M24 X 3.00 X 180	10
*****	M22 X 2.50 X 90	10	*****	M24 X 3.00 X 200	10
*****	M22 X 2.50 X 100	10	*****	M24 X 3.00 X 220	5
*****	M22 X 2.50 X 110	10	*****	M24 X 3.00 X 240	5
*****	M22 X 2.50 X 120	10	*****	M24 X 3.00 X 260	5

AUTRES DIMENSIONS DISPONIBLES / OTHER DIMENSIONS AVAILABLE



Tel.: (819) 346-2903 / (888) 345-2903 Fax.: (819) 346-3389

Email: distributeur@boulonstrie.com

B-26

VIS À TÊTE
CYLINDRIQUE
À 6 PANS CREUX
GROS FILETS

GRADE 12.9
MÉTRIQUE / METRIC DIN 912

SOCKET HEAD
CAP SCREWS
NATIONAL COARSE

NOIR / BARE

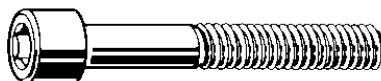

NOTRE CODE	DESCRIPTION	QTÉ/BTE	NOTRE CODE	DESCRIPTION	QTÉ/BTE
OUR CODE	DESCRIPTION	QTY/BOX	OUR CODE	DESCRIPTION	QTY/BOX
*****	M24 X 3.00 X 280	5	*****	M30 X 3.50 X 130	1
*****	M24 X 3.00 X 300	5	*****	M30 X 3.50 X 140	1
*****	M24 X 3.00 X 320	1	*****	M30 X 3.50 X 150	1
*****	M24 X 3.00 X 340	1	*****	M30 X 3.50 X 160	1
*****	M27 X 3.00 X 80	5	*****	M30 X 3.50 X 180	1
*****	M27 X 3.00 X 90	5	*****	M30 X 3.50 X 200	1
*****	M27 X 3.00 X 100	5	*****	M30 X 3.50 X 240	1
*****	M27 X 3.00 X 110	5	*****	M30 X 3.50 X 260	1
*****	M27 X 3.00 X 120	5	*****	M30 X 3.50 X 300	1
*****	M27 X 3.00 X 130	5	*****	M30 X 3.50 X 320	1
*****	M27 X 3.00 X 140	5	*****	M30 X 3.50 X 360	1
*****	M27 X 3.00 X 150	5	*****	M30 X 3.50 X 380	1
*****	M27 X 3.00 X 160	5	*****	M30 X 3.50 X 400	1
*****	M27 X 3.00 X 180	5	*****	M36 X 4.00 X 70	1
*****	M27 X 3.00 X 200	1	*****	M36 X 4.00 X 80	1
*****	M27 X 3.00 X 220	1	*****	M36 X 4.00 X 90	1
*****	M27 X 3.00 X 240	1	*****	M36 X 4.00 X 100	1
*****	M27 X 3.00 X 260	1	*****	M36 X 4.00 X 110	1
*****	M27 X 3.00 X 280	1	*****	M36 X 4.00 X 120	1
*****	M27 X 3.00 X 300	1	*****	M36 X 4.00 X 130	1
*****	M30 X 3.50 X 70	1	*****	M36 X 4.00 X 140	1
*****	M30 X 3.50 X 80	1	*****	M36 X 4.00 X 150	1
*****	M30 X 3.50 X 90	1	*****	M36 X 4.00 X 160	1
*****	M30 X 3.50 X 100	1	*****	M36 X 4.00 X 180	1
*****	M30 X 3.50 X 110	1	*****	M36 X 4.00 X 200	1
*****	M30 X 3.50 X 120	1	*****	M36 X 4.00 X 240	1

AUTRES DIMENSIONS DISPONIBLES / OTHER DIMENSIONS AVAILABLE



Tel.: (819) 346-2903 / (888) 345-2903 Fax.: (819) 346-3389

Email: distributeur@boulonstrie.com

B-27

**VIS À TÊTE
CYLINDRIQUE
À 6 PANS CREUX
GROS FILETS**

**GRADE 12.9
MÉTRIQUE / METRIC DIN 912**

**SOCKET HEAD
CAP SCREWS
NATIONAL COARSE**

NOIR / BARE

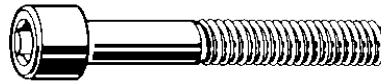

NOTRE CODE	DESCRIPTION	QTÉ/BTE	NOTRE CODE	DESCRIPTION	QTÉ/BTE
OUR CODE	DESCRIPTION	QTY/BOX	OUR CODE	DESCRIPTION	QTY/BOX
*****	M36 X 4.00 X 260	1	*****	M42 X 4.50 X 220	1
*****	M36 X 4.00 X 300	1	*****	M42 X 4.50 X 240	1
*****	M36 X 4.00 X 320	1	*****	M42 X 4.50 X 260	1
*****	M36 X 4.00 X 360	1	*****	M42 X 4.50 X 280	1
*****	M36 X 4.00 X 380	1	*****	M42 X 4.50 X 300	1
*****	M36 X 4.00 X 400	1	*****	M42 X 4.50 X 320	1
*****	M42 X 4.50 X 100	1	*****	M42 X 4.50 X 340	1
*****	M42 X 4.50 X 110	1	*****	M42 X 4.50 X 360	1
*****	M42 X 4.50 X 120	1	*****	M42 X 4.50 X 380	1
*****	M42 X 4.50 X 130	1	*****	M42 X 4.50 X 400	1
*****	M42 X 4.50 X 140	1	AUSSI DISPONIBLE ALSO AVAILABLE MÉTRIQUE ACIER INOXYDABLE METRIC STAINLESS STEEL		
*****	M42 X 4.50 X 150	1			
*****	M42 X 4.50 X 160	1			
*****	M42 X 4.50 X 180	1			
*****	M42 X 4.50 X 200	1			

AUTRES DIMENSIONS DISPONIBLES /OTHER DIMENSIONS AVAILABLE



Tel.: (819) 346-2903 / (888) 345-2903 Fax.: (819) 346-3389

Email: distributeur@boulonsestrie.com

B-28

**VIS À TÊTE BASSE
À 6 PANS CREUX
GROS FILETS**

**NOIR / BARE
ALLOY STEEL**

**LOW HEAD SOCKET
CAP SCREWS
NATIONAL COARSE**

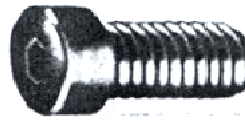

NOTRE CODE	DESCRIPTION	QTÉ/BTE
OUR CODE	DESCRIPTION	QTY/BOX
*****	8-32 X 3/8	100
*****	8-32 X 1/2	100
*****	8-32 X 5/8	100
*****	8-32 X 3/4	100
*****	8-32 X 1	100
*****	10-24 X 3/8	100
*****	10-24 X 1/2	100
*****	10-24 X 5/8	100
*****	10-24 X 3/4	100
*****	10-24 X 1	100
*****	10-32 X 3/8	100
*****	10-32 X 1/2	100
*****	10-32 X 5/8	100
*****	10-32 X 3/4	100
*****	10-32 X 1	100
*****	1/4 -20 X 3/8	100
SL025005	1/4-20 X 1/2	100
SL025006	1/4-20 X 5/8	100
*****	1/4-20 X 3/4	100
SL025010	1/4-20 X 1	100
*****	1/4-20 X 1 1/4	100
*****	5/16-18 X 1/2	100
*****	5/16-18 X 5/8	100
SL031007	5/16-18 X 3/4	100
SL031010	5/16-18 X 1	100
*****	5/16-18 X 1 1/4	100
*****	5/16-18 X 1 1/2	100

AUTRES DIMENSIONS DISPONIBLES / OTHER DIMENSIONS AVAILABLE



**Tel.: (819) 346-2903 / (888) 345-2903 Fax.: (819) 346-3389
Email: distributeur@boulonsestrie.com**

B-29

**VIS À TÊTE BASSE
À 6 PANS CREUX
GROS FILETS**

**NOIR / BARE
ALLOY STEEL**

**LOW HEAD SOCKET
CAP SCREWS
NATIONAL COARSE**

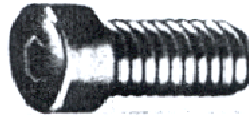

NOTRE CODE	DESCRIPTION	QTÉ/BTE
OUR CODE	DESCRIPTION	QTY/BOX
*****	3/8-16 X 1/2	100
*****	3/8-16 X 5/8	100
SL037007	3/8-16 X 3/4	100
SL037010	3/8-16 X 1	100
SL037012	3/8-16 X 1 1/4	100
*****	3/8-16 X 1 1/2	100
*****	1/2-13 X 3/4	50
SL050010	1/2-13 X 1	50
SL050012	1/2-13 X 1 1/4	50
SL050015	1/2-13 X 1 1/2	50

AUTRES DIMENSIONS DISPONIBLES / OTHER DIMENSIONS AVAILABLE



**Tel.: (819) 346-2903 / (888) 345-2903 Fax.: (819) 346-3389
Email: distributeur@boulonsestrie.com**

VIS À TÊTE BASSE
À 6 PANS CREUX
GROS FILETS

MÉTRIQUE DIN 7984 METRIC

LOW HEAD SOCKET
CAP SCREWS
NATIONAL COARSE



NOTRE CODE	DESCRIPTION	QTÉ/BTE	NOTRE CODE	DESCRIPTION	QTÉ/BTE
OUR CODE	DESCRIPTION	QTY/BOX	OUR CODE	DESCRIPTION	QTY/BOX
*****	M4 X .70 X 6	100	SL208020	M8 X 1.25 X 20	100
*****	M4 X .70 X 8	100	SL208025	M8 X 1.25 X 25	100
*****	M4 X .70 X 10	100	SL208030	M8 X 1.25 X 30	100
*****	M4 X .70 X 12	100	SL208035	M8 X 1.25 X 35	100
*****	M4 X .70 X 16	100	*****	M10 X 1.50 X 12	100
*****	M4 X .70 X 20	100	*****	M10 X 1.50 X 16	100
*****	M4 X .70 X 25	100	*****	M10 X 1.50 X 20	100
*****	M5 X .80 X 10	100	SL210025	M10 X 1.50 X 25	100
SL205012	M5 X .80 X 12	100	SL210030	M10 X 1.50 X 30	100
SL205016	M5 X .80 X 16	100	SL210035	M10 X 1.50 X 35	100
*****	M5 X .80 X 20	100	*****	M12 X 2.00 X 20	50
*****	M5 X .80 X 25	100	SL212025	M12 X 2.00 X 25	50
SL206010	M6 X 1.00 X 10	100	*****	M12 X 2.00 X 30	50
*****	M6 X 1.00 X 12	100	*****	M12 X 2.00 X 35	50
*****	M6 X 1.00 X 16	100	*****	M12 X 2.00 X 40	50
SL206020	M6 X 1.00 X 20	100	*****	M12 X 2.00 X 50	50
SL206025	M6 X 1.00 X 25	100	*****	M12 X 2.00 X 60	50
*****	M6 X 1.00 X 30	100	*****	M12 X 2.00 X 80	50
*****	M8 X 1.25 X 10	100	SL216040	M16 X 2.00 X 40	50
SL208012	M8 X 1.25 X 12	100	SL216050	M16 X 2.00 X 50	50
SL208016	M8 X 1.25 X 16	100	SL216060	M16 X 2.00 X 60	25

AUTRES DIMENSIONS DISPONIBLES / OTHER DIMENSIONS ARE AVAILABLE



Tel.: (819) 346-2903 / (888) 345-2903 Fax.: (819) 346-3389

Email: distributeur@boulonstrie.com

VIS À TÊTE FRAISÉE
À 6 PANS CREUX
GROS FILETS

NOIR / BARE
ALLOY STEEL

FLAT HEAD SOCKET
CAP SCREWS
NATIONAL COARSE

LA FINITION PLAQUÉE ZINC
EST DISPONIBLE
SUR DEMANDE

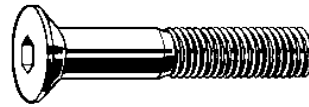

ZINC PLATED IS
AVAILABLE ON REQUEST

NOTRE CODE	DESCRIPTION	QTÉ/BTE	NOTRE CODE	DESCRIPTION	QTÉ/BTE
OUR CODE	DESCRIPTION	QTY/BOX	OUR CODE	DESCRIPTION	QTY/BOX
*****	2-56 X 1/8	SEMI-STD	*****	4-40 X 1 1/4	SEMI-STD
*****	2-56 X 3/16	100	SF005002	5-40 X 1/4	100
SF002002	2-56 X 1/4	100	SF005004	5-40 X 3/8	100
*****	2-56 X 5/16	SEMI-STD	SF005005	5-40 X 1/2	100
SF002004	2-56 X 3/8	100	*****	5-40 X 5/8	100
*****	2-56 X 1/2	100	SF005007	5-40 X 3/4	100
*****	2-56 X 5/8	SEMI-STD	*****	5-40 X 1	SEMI-STD
*****	2-56 X 3/4	SEMI-STD	*****	5-40 X 1 1/4	SEMI-STD
*****	2-56 X 7/8	SEMI-STD	*****	5-40 X 1 1/2	SEMI-STD
*****	2-56 X 1	SEMI-STD	SF006001	6-32 X 3/16	SEMI-STD
*****	3-48 X 3/16	100	SF006002	6-32 X 1/4	100
*****	3-48 X 1/4	100	SF006003	6-32 X 5/16	SEMI-STD
*****	3-48 X 5/16	SEMI-STD	SF006004	6-32 X 3/8	100
*****	3-48 X 3/8	100	*****	6-32 X 7/16	SEMI-STD
*****	3-48 X 1/2	100	SF006005	6-32 X 1/2	100
*****	3-48 X 5/8	SEMI-STD	SF006006	6-32 X 5/8	100
*****	3-48 X 3/4	SEMI-STD	SF006007	6-32 X 3/4	100
*****	3-48 X 1	SEMI-STD	*****	6-32 X 7/8	SEMI-STD
SF004000	4-40 X 3/16	SEMI-STD	SF006010	6-32 X 1	SEMI-STD
SF004002	4-40 X 1/4	100	*****	6-32 X 1 1/4	SEMI-STD
SF004003	4-40 X 5/16	SEMI-STD	*****	6-32 X 1 1/2	SEMI-STD
SF004004	4-40 X 3/8	100	*****	6-32 X 1 3/4	SEMI-STD
*****	4-40 X 7/16	SEMI-STD	SF006020	6-32 X 2	SEMI-STD
SF004005	4-40 X 1/2	100	*****	6-32 X 2 1/4	SEMI-STD
*****	4-40 X 5/8	100	*****	6-32 X 2 1/2	SEMI-STD
SF004007	4-40 X 3/4	100	*****	6-32 X 3	SEMI-STD
*****	4-40 X 7/8	SEMI-STD	SF008002	8-32 X 1/4	SEMI-STD
*****	4-40 X 1	SEMI-STD	SF008003	8-32 X 5/16	SEMI-STD

SEMI-STD PLUSIEURS QUANTITÉS DISPONIBLES / SEMI-STD PACKAGING ANY QUANTITY



Tel.: (819) 346-2903 / (888) 345-2903 Fax.: (819) 346-3389
Email: distributeur@boulonstrie.com

B-32

VIS À TÊTE FRAISÉE
 À 6 PANS CREUX
 GROS FILETS

NOIR / BARE
 ALLOY STEEL

FLAT HEAD SOCKET
 CAP SCREWS
 NATIONAL COARSE

LA FINITION PLAQUÉE ZINC
 EST DISPONIBLE
 SUR DEMANDE

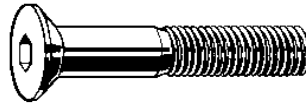

ZINC PLATED IS
 AVAILABLE ON REQUEST

NOTRE CODE	DESCRIPTION	QTÉ/BTE	NOTRE CODE	DESCRIPTION	QTÉ/BTE
OUR CODE	DESCRIPTION	QTY/BOX	OUR CODE	DESCRIPTION	QTY/BOX
SF008004	8-32 X 3/8	100	*****	10-24 X 3	SEMI-STD
*****	8-32 X 7/16	SEMI-STD	SF012005	12-24 X 1/2	SEMI-STD
SF008005	8-32 X 1/2	100	*****	12-24 X 5/8	SEMI-STD
SF008006	8-32 X 5/8	100	SF012007	12-24 X 3/4	SEMI-STD
SF008007	8-32 X 3/4	100	SF012010	12-24 X 1	SEMI-STD
SF008008	8-32 X 7/8	SEMI-STD	SF025003	1/4-20 X 3/8	100
SF008010	8-32 X 1	100	SF025005	1/4-20 X 1/2	100
SF008012	8-32 X 1 1/4	SEMI-STD	SF025006	1/4-20 X 5/8	100
SF008015	8-32 X 1 1/2	SEMI-STD	SF025007	1/4-20 X 3/4	100
*****	8-32 X 1 3/4	SEMI-STD	*****	1/4-20 X 7/8	SEMI-STD
SF008020	8-32 X 2	SEMI-STD	SF025010	1/4-20 X 1	100
*****	8-32 X 2 1/4	SEMI-STD	*****	1/4-20 X 1 1/8	SEMI-STD
*****	8-32 X 2 1/2	SEMI-STD	SF025012	1/4-20 X 1 1/4	100
SF010002	10-24 X 1/4	SEMI-STD	SF025015	1/4-20 X 1 1/2	100
SF010003	10-24 X 5/16	SEMI-STD	SF025017	1/4-20 X 1 3/4	100
SF010004	10-24 X 3/8	100	SF025020	1/4-20 X 2	100
*****	10-24 X 7/16	SEMI-STD	SF025022	1/4-20 X 2 1/4	SEMI-STD
SF010005	10-24 X 1/2	100	SF025025	1/4-20 X 2 1/2	SEMI-STD
SF010006	10-24 X 5/8	100	*****	1/4-20 X 2 3/4	SEMI-STD
SF010007	10-24 X 3/4	100	SF025030	1/4-20 X 3	SEMI-STD
*****	10-24 X 7/8	SEMI-STD	SF025035	1/4-20 X 3 1/2	SEMI-STD
SF010010	10-24 X 1	100	*****	1/4-20 X 4	SEMI-STD
SF010012	10-24 X 1 1/4	100	*****	5/16-18 X 1/4	100
SF010015	10-24 X 1 1/2	100	SF031004	5/16-18 X 3/8	SEMI-STD
SF010017	10-24 X 1 3/4	SEMI-STD	SF031005	5/16-18 X 1/2	100
SF010020	10-24 X 2	SEMI-STD	SF031006	5/16-18 X 5/8	100
SF010022	10-24 X 2 1/4	SEMI-STD	SF031007	5/16-18 X 3/4	100
SF010025	10-24 X 2 1/2	SEMI-STD	SF031008	5/16-18 X 7/8	SEMI-STD

SEMI-STD PLUSIEURS QUANTITÉS DISPONIBLES / SEMI-STD PACKAGING ANY QUANTITY



Tel.: (819) 346-2903 / (888) 345-2903 Fax.: (819) 346-3389
 Email: distributeur@boulonsestrie.com

VIS À TÊTE FRAISÉE
 À 6 PANS CREUX
 GROS FILETS

NOIR / BARE
 ALLOY STEEL

FLAT HEAD SOCKET
 CAP SCREWS
 NATIONAL COARSE

LA FINITION PLAQUÉE ZINC
 EST DISPONIBLE
 SUR DEMANDE

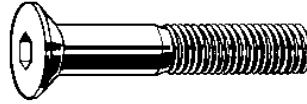

ZINC PLATED IS
 AVAILABLE ON REQUEST

NOTRE CODE	DESCRIPTION	QTÉ/BTE	NOTRE CODE	DESCRIPTION	QTÉ/BTE
OUR CODE	DESCRIPTION	QTY/BOX	OUR CODE	DESCRIPTION	QTY/BOX
SF031010	5/16-18 X 1	100	*****	3/8-16 X 5	SEMI-STD
SF031012	5/16-18 X 1 1/4	100	*****	3/8-16 X 5 1/2	SEMI-STD
SF031015	5/16-18 X 1 1/2	100	*****	3/8-16 X 6	SEMI-STD
SF031017	5/16-18 X 1 3/4	100	*****	7/16 -14 X 3/4	100
SF031020	5/16-18 X 2	100	*****	7/16-14 X 7/8	SEMI-STD
SF031022	5/16-18 X 2 1/4	100	SF043010	7/16-14 X 1	100
SF031025	5/16-18 X 2 1/2	100	SF043012	7/16-14 X 1 1/4	100
*****	5/16-18 X 2 3/4	SEMI-STD	SF043015	7/16-14 X 1 1/2	100
SF031030	5/16-18 X 3	SEMI-STD	SF043017	7/16-14 X 1 3/4	100
*****	5/16-18 X 3 1/2	SEMI-STD	SF043020	7/16-14 X 2	50
*****	5/16-18 X 4	SEMI-STD	SF043022	7/16-14 X 2 1/4	SEMI-STD
SF037005	3/8-16 X 1/2	100	*****	7/16-14 X 2 1/2	SEMI-STD
SF037006	3/8-16 X 5/8	100	*****	7/16-14 X 3	SEMI-STD
SF037007	3/8-16 X 3/4	100	*****	7/16-14 X 3 1/2	SEMI-STD
*****	3/8-16 X 7/8	SEMI-STD	*****	7/16-14 X 4	SEMI-STD
SF037010	3/8-16 X 1	100	SF050007	1/2-13 X 3/4	100
SF037012	3/8-16 X 1 1/4	100	*****	1/2-13 X 7/8	SEMI-STD
SF037014	3/8-16 X 1 3/8	SEMI-STD	SF050010	1/2-13 X 1	100
SF037015	3/8-16 X 1 1/2	100	SF050012	1/2-13 X 1 1/4	100
SF037017	3/8-16 X 1 3/4	100	SF050015	1/2-13 X 1 1/2	100
SF037020	3/8-16 X 2	100	SF050017	1/2-13 X 1 3/4	50
SF037022	3/8-16 X 2 1/4	100	SF050020	1/2-13 X 2	50
SF037025	3/8-16 X 2 1/2	100	SF050022	1/2-13 X 2 1/4	50
SF037027	3/8-16 X 2 3/4	SEMI-STD	SF050025	1/2-13 X 2 1/2	50
SF037030	3/8-16 X 3	100	SF050027	1/2-13 X 2 3/4	SEMI-STD
SF037035	3/8-16 X 3 1/2	SEMI-STD	SF050030	1/2-13 X 3	50
SF037040	3/8-16 X 4	SEMI-STD	*****	1/2-13 X 3 1/4	SEMI-STD
SF037045	3/8-16 X 4 1/2	SEMI-STD	SF050035	1/2-13 X 3 1/2	SEMI-STD

SEMI-STD PLUSIEURS QUANTITÉS DISPONIBLES / SEMI-STD PACKAGING ANY QUANTITY



Tel.: (819) 346-2903 / (888) 345-2903 Fax.: (819) 346-3389
 Email: distributeur@boulonsestrie.com

VIS À TÊTE FRAISÉE
 À 6 PANS CREUX
 GROS FILETS

NOIR / BARE
 ALLOY STEEL

FLAT HEAD SOCKET
 CAP SCREWS
 NATIONAL COARSE

LA FINITION PLAQUÉE ZINC
 EST DISPONIBLE
 SUR DEMANDE

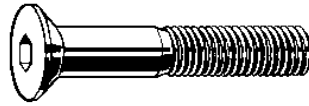

ZINC PLATED IS
 AVAILABLE ON REQUEST

NOTRE CODE	DESCRIPTION	QTÉ/BTE	NOTRE CODE	DESCRIPTION	QTÉ/BTE
OUR CODE	DESCRIPTION	QTY/BOX	OUR CODE	DESCRIPTION	QTY/BOX
SF050040	1/2-13 X 4	SEMI-STD	*****	3/4-10 X 2 1/4	25
SF050045	1/2-13 X 4 1/2	SEMI-STD	SF075025	3/4-10 X 2 1/2	25
SF050050	1/2-13 X 5	SEMI-STD	*****	3/4-10 X 2 3/4	SEMI-STD
SF050060	1/2-13 X 6	SEMI-STD	SF075030	3/4-10 X 3	25
*****	1/2-13 X 7	SEMI-STD	*****	3/4-10 X 3 1/4	SEMI-STD
*****	1/2-13 X 8	SEMI-STD	*****	3/4-10 X 3 1/2	SEMI-STD
SF062010	5/8-11 X 1	SEMI-STD	SF075040	3/4-10 X 4	SEMI-STD
SF062012	5/8-11 X 1 1/4	50	SF075045	3/4-10 X 4 1/2	SEMI-STD
SF062015	5/8-11 X 1 1/2	50	*****	3/4-10 X 5	SEMI-STD
SF062017	5/8-11 X 1 3/4	50	*****	3/4-10 X 6	SEMI-STD
SF062020	5/8-11 X 2	50	*****	3/4-10 X 6 1/2	SEMI-STD
SF062022	5/8-11 X 2 1/4	25	*****	3/4-10 X 7	SEMI-STD
SF062025	5/8-11 X 2 1/2	25	SF075080	3/4-10 X 8	SEMI-STD
SF062027	5/8-11 X 2 3/4	SEMI-STD	*****	7/8-9 X 2	SEMI-STD
SF062030	5/8-11 X 3	25	SF087025	7/8-9 X 2 1/2	SEMI-STD
SF062035	5/8-11 X 3 1/2	SEMI-STD	*****	7/8-9 X 3	SEMI-STD
*****	5/8-11 X 4	SEMI-STD	*****	7/8-9 X 3 1/2	SEMI-STD
SF062045	5/8-11 X 4 1/2	SEMI-STD	*****	7/8-9 X 4	SEMI-STD
*****	5/8-11 X 5	SEMI-STD	SF087045	7/8-9 X 4 1/2	SEMI-STD
*****	5/8-11 X 6	SEMI-STD	*****	7/8-9 X 5	SEMI-STD
*****	5/8-11 X 6 1/2	SEMI-STD	*****	7/8-9 X 6	SEMI-STD
*****	5/8-11 X 7	SEMI-STD	*****	7/8-9 X 6 1/2	SEMI-STD
*****	5/8-11 X 8	SEMI-STD	*****	7/8-9 X 7	SEMI-STD
*****	3/4-10 X 1	SEMI-STD	*****	7/8-9 X 8	SEMI-STD
SF075012	3/4-10 X 1 1/4	25	*****	1-8 X 2	SEMI-STD
SF075015	3/4-10 X 1 1/2	25	*****	1-8 X 2 1/4	SEMI-STD
SF075017	3/4-10 X 1 3/4	25	*****	1-8 X 2 1/2	SEMI-STD
SF075020	3/4-10 X 2	25	*****	1-8 X 2 3/4	SEMI-STD

SEMI-STD PLUSIEURS QUANTITÉS DISPONIBLES / SEMI-STD PACKAGING ANY QUANTITY



Tel.: (819) 346-2903 / (888) 345-2903 Fax.: (819) 346-3389
 Email: distributeur@boulonstrie.com

**VIS À TÊTE FRAISÉE
À 6 PANS CREUX
GROS FILETS**

**NOIR / BARE
ALLOY STEEL**

**FLAT HEAD SOCKET
CAP SCREWS
NATIONAL COARSE**

**LA FINITION PLAQUÉE ZINC
EST DISPONIBLE
SUR DEMANDE**

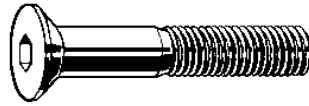

**ZINC PLATED IS
AVAILABLE ON REQUEST**

NOTRE CODE	DESCRIPTION	QTÉ/BTE	NOTRE CODE	DESCRIPTION	QTÉ/BTE
OUR CODE	DESCRIPTION	QTY/BOX	OUR CODE	DESCRIPTION	QTY/BOX
SF090030	1-8 X 3	SEMI-STD	*****	1-8 X 8	SEMI-STD
*****	1-8 X 3 1/2	SEMI-STD	*****	1 1/4-7 X 3	SEMI-STD
SF090040	1-8 X 4	SEMI-STD	*****	1 1/4-7 X 3 1/2	SEMI-STD
*****	1-8 X 4 1/2	SEMI-STD	*****	1 1/4-7 X 4	SEMI-STD
*****	1-8 X 5	SEMI-STD	*****	1 1/4-7 X 5	SEMI-STD
*****	1-8 X 6	SEMI-STD	*****	1 1/4-7 X 6	SEMI-STD
*****	1-8 X 6 1/2	SEMI-STD	*****	1 1/4-7 X 7	SEMI-STD
*****	1-8 X 7	SEMI-STD	*****	1 1/4-7 X 8	SEMI-STD

SEMI-STD PLUSIEURS QUANTITÉS DISPONIBLES / SEMI-STD PACKAGING ANY QUANTITY



**Tel.: (819) 346-2903 / (888) 345-2903 Fax.: (819) 346-3389
Email: distributeur@boulonsestrie.com**

B-36

VIS À TÊTE FRAISÉE
À 6 PANS CREUX
FILETS FINS

NOIR / BARE
ALLOY STEEL

FLAT HEAD SOCKET
CAP SCREWS
NATIONAL FINE

LA FINITION PLAQUÉE ZINC
EST DISPONIBLE
SUR DEMANDE

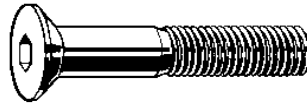

ZINC PLATED IS
AVAILABLE ON REQUEST

NOTRE CODE	DESCRIPTION	QTÉ/BTE	NOTRE CODE	DESCRIPTION	QTÉ/BTE
OUR CODE	DESCRIPTION	QTY/BOX	OUR CODE	DESCRIPTION	QTY/BOX
*****	0-80 X 1/8	100	*****	6-40 X 3/4	SEMI-STD
*****	0-80 X 3/16	100	SF106010	6-40 X 1	SEMI-STD
*****	0-80 X 1/4	100	*****	8-36 X 3/8	SEMI-STD
*****	0-80 X 5/16	SEMI-STD	SF108005	8-36 X 1/2	SEMI-STD
*****	0-80 X 3/8	SEMI-STD	*****	8-36 X 5/8	SEMI-STD
*****	0-80 X 1/2	SEMI-STD	*****	8-36 X 3/4	SEMI-STD
*****	0-80 X 5/8	SEMI-STD	SF108010	8-36 X 1	SEMI-STD
*****	0-80 X 3/4	SEMI-STD	SF110002	10-32 X 1/4	100
*****	0-80 X 1	SEMI-STD	*****	10-32 X 5/16	100
SF101012	1-72 X 1/8	100	SF110003	10-32 X 3/8	SEMI-STD
*****	1-72 X 3/16	100	*****	10-32 X 7/16	SEMI-STD
*****	1-72 X 1/4	100	SF110005	10-32 X 1/2	100
*****	1-72 X 5/16	SEMI-STD	SF110006	10-32 X 5/8	100
*****	1-72 X 3/8	100	SF110007	10-32 X 3/4	100
*****	1-72 X 1/2	SEMI-STD	*****	10-32 X 7/8	SEMI-STD
*****	1-72 X 5/8	SEMI-STD	SF110010	10-32 X 1	100
*****	1-72 X 3/4	SEMI-STD	*****	10-32 X 1 1/8	SEMI-STD
*****	1-72 X 1	SEMI-STD	SF110012	10-32 X 1 1/4	100
*****	4-48 X 1/4	SEMI-STD	SF110015	10-32 X 1 1/2	100
*****	4-48 X 3/8	SEMI-STD	SF110017	10-32 X 1 3/4	SEMI-STD
*****	4-48 X 1/2	SEMI-STD	SF110020	10-32 X 2	SEMI-STD
*****	4-48 X 5/8	SEMI-STD	*****	10-32 X 2 1/4	SEMI-STD
*****	4-48 X 3/4	SEMI-STD	SF110025	10-32 X 2 1/2	SEMI-STD
*****	4-48 X 1	SEMI-STD	*****	10-32 X 3	SEMI-STD
SF106002	6-40 X 1/4	SEMI-STD	SF125004	1/4-28 X 3/8	100
SF106004	6-40 X 3/8	SEMI-STD	SF125005	1/4-28 X 1/2	100
SF106005	6-40 X 1/2	SEMI-STD	SF125006	1/4-28 X 5/8	100
SF106006	6-40 X 5/8	SEMI-STD	SF125007	1/4-28 X 3/4	100

SEMI-STD PLUSIEURS QUANTITÉS DISPONIBLES / SEMI-STD PACKAGING ANY QUANTITY



Tel.: (819) 346-2903 / (888) 345-2903 Fax.: (819) 346-3389

Email: distributeur@boulonstrie.com

B-37

VIS À TÊTE FRAISÉE
À 6 PANS CREUX
FILETS FINS

NOIR / BARE
ALLOY STEEL

FLAT HEAD SOCKET
CAP SCREWS
NATIONAL FINE

LA FINITION PLAQUÉE ZINC
EST DISPONIBLE
SUR DEMANDE

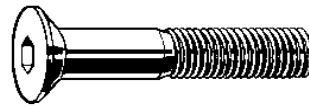

ZINC PLATED IS
AVAILABLE ON REQUEST

NOTRE CODE	DESCRIPTION	QTÉ/BTE	NOTRE CODE	DESCRIPTION	QTÉ/BTE
OUR CODE	DESCRIPTION	QTY/BOX	OUR CODE	DESCRIPTION	QTY/BOX
SF125008	1/4-28 X 7/8	SEMI-STD	SF137010	3/8-24 X 1	100
SF125010	1/4-28 X 1	100	SF137012	3/8-24 X 1 1/4	100
SF125012	1/4-28 X 1 1/4	100	SF137015	3/8-24 X 1 1/2	100
SF125015	1/4-28 X 1 1/2	100	*****	3/8-24 X 1 3/4	SEMI-STD
*****	1/4-28 X 1 3/4	SEMI-STD	*****	3/8-24 X 2	SEMI-STD
*****	1/4-28 X 2	SEMI-STD	*****	3/8-24 X 2 1/4	SEMI-STD
*****	1/4-28 X 2 1/4	SEMI-STD	*****	3/8-24 X 2 1/2	SEMI-STD
*****	1/4-28 X 2 1/2	SEMI-STD	*****	3/8-24 X 2 3/4	SEMI-STD
*****	1/4-28 X 3	SEMI-STD	*****	3/8-24 X 3	SEMI-STD
*****	1/4-28 X 3 1/2	SEMI-STD	*****	3/8-24 X 3 1/4	SEMI-STD
SF131004	5/16-24 X 3/8	SEMI-STD	*****	3/8-24 X 3 1/2	SEMI-STD
SF131005	5/16-24 X 1/2	100	*****	7/16-20 X 3/4	SEMI-STD
SF131006	5/16-24 X 5/8	100	SF143010	7/16-20 X 1	SEMI-STD
SF131007	5/16-24 X 3/4	100	*****	7/16-20 X 1 1/4	SEMI-STD
*****	5/16-24 X 7/8	SEMI-STD	*****	7/16-20 X 1 1/2	SEMI-STD
SF131010	5/16-24 X 1	100	*****	7/16-20 X 1 3/4	SEMI-STD
SF131012	5/16-24 X 1 1/4	100	SF143020	7/16-20 X 2	SEMI-STD
SF131015	5/16-24 X 1 1/2	100	*****	7/16-20 X 2 1/2	SEMI-STD
*****	5/16-24 X 1 3/4	SEMI-STD	*****	7/16-20 X 3	SEMI-STD
*****	5/16-24 X 2	SEMI-STD	SF150007	1/2-20 X 3/4	100
*****	5/16-24 X 2 1/4	SEMI-STD	SF150010	1/2-20 X 1	100
*****	5/16-24 X 2 1/2	SEMI-STD	*****	1/2-20 X 1 1/4	100
*****	5/16-24 X 3	SEMI-STD	SF150015	1/2-20 X 1 1/2	100
*****	5/16-24 X 3 1/2	SEMI-STD	SF150017	1/2-20 X 1 3/4	100
*****	3/8-24 X 1/2	SEMI-STD	*****	1/2-20 X 2	100
SF137006	3/8-24 X 5/8	100	*****	1/2-20 X 2 1/4	SEMI-STD
SF137007	3/8-24 X 3/4	100	*****	1/2-20 X 2 1/2	SEMI-STD
*****	3/8-24 X 7/8	SEMI-STD	*****	1/2-20 X 3	SEMI-STD

SEMI-STD PLUSIEURS QUANTITÉS DISPONIBLES / SEMI-STD PACKAGING ANY QUANTITY



Tel.: (819) 346-2903 / (888) 345-2903 Fax.: (819) 346-3389

Email: distributeur@boulonstrie.com

B-38

VIS À TÊTE FRAISÉE
 À 6 PANS CREUX
 FILETS FINS

NOIR / BARE
 ALLOY STEEL

FLAT HEAD SOCKET
 CAP SCREWS
 NATIONAL FINE

LA FINITION PLAQUÉE ZINC
 EST DISPONIBLE
 SUR DEMANDE

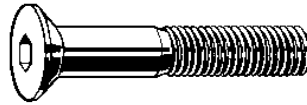

ZINC PLATED IS
 AVAILABLE ON REQUEST

NOTRE CODE	DESCRIPTION	QTÉ/BTE	NOTRE CODE	DESCRIPTION	QTÉ/BTE
OUR CODE	DESCRIPTION	QTY/BOX	OUR CODE	DESCRIPTION	QTY/BOX
*****	1/2-20 X 3 1/2	SEMI-STD	*****	5/8-18 X 4	SEMI-STD
*****	1/2-20 X 4	SEMI-STD	*****	3/4-16 X 1 1/4	SEMI-STD
*****	5/8-18 X 1	SEMI-STD	SF175015	3/4-16 X 1 1/2	SEMI-STD
*****	5/8-18 X 1 1/4	SEMI-STD	*****	3/4-16 X 1 3/4	SEMI-STD
*****	5/8-18 X 1 1/2	SEMI-STD	*****	3/4-16 X 2	SEMI-STD
SF162017	5/8-18 X 1 3/4	SEMI-STD	*****	3/4-16 X 2 1/4	SEMI-STD
SF162020	5/8-18 X 2	SEMI-STD	*****	3/4-16 X 2 1/2	SEMI-STD
*****	5/8-18 X 2 1/4	SEMI-STD	*****	3/4-16 X 3	SEMI-STD
*****	5/8-18 X 2 1/2	SEMI-STD	*****	3/4-16 X 3 1/2	SEMI-STD
*****	5/8-18 X 3	SEMI-STD	*****	3/4-16 X 4	SEMI-STD
SF162035	5/8-18 X 3 1/2	SEMI-STD			

SEMI-STD PLUSIEURS QUANTITÉS DISPONIBLES / SEMI-STD PACKAGING ANY QUANTITY



Tel.: (819) 346-2903 / (888) 345-2903 Fax.: (819) 346-3389

Email: distributeur@boulonsestrie.com

B-39

VIS À TÊTE FRAISÉE
À 6 PANS CREUX
GROS FILETS

SS-304
18-8

FLAT HEAD SOCKET
CAP SCREWS
NATIONAL COARSE

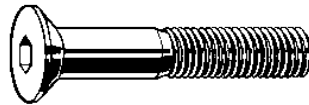

NOTRE CODE	DESCRIPTION	QTÉ/BTE	NOTRE CODE	DESCRIPTION	QTÉ/BTE
OUR CODE	DESCRIPTION	QTY/BOX	OUR CODE	DESCRIPTION	QTY/BOX
SF404004	4-40 X 3/8	100	SF425005	1/4-20 X 1/2	100
SF404005	4-40 X 1/2	100	SF425006	1/4-20 X 5/8	100
SF404007	4-40 X 3/4	100	SF425007	1/4-20 X 3/4	100
SF406002	6-32 X 1/4	100	SF425010	1/4-20 X 1	100
SF406004	6-32 X 3/8	100	SF425012	1/4-20 X 1 1/4	100
SF406005	6-32 X 1/2	100	SF425015	1/4-20 X 1 1/2	100
SF406007	6-32 X 3/4	100	SF425017	1/4-20 X 1 3/4	100
SF406020	6-32 X 2	100	SF425020	1/4-20 X 2	100
SF408004	8-32 X 3/8	100	SF425025	1/4-20 X 2 1/2	100
SF408005	8-32 X 1/2	100	SF431005	5/16-18 X 1/2	100
SF408007	8-32 X 3/4	100	SF431006	5/16-18 X 5/8	100
SF410004	10-24 X 3/8	100	SF431007	5/16-18 X 3/4	100
SF410005	10-24 X 1/2	100	SF431010	5/16-18 X 1	100
SF410007	10-24 X 3/4	100	SF431012	5/16-18 X 1 1/4	100
SF410010	10-24 X 1	100	SF431015	5/16-18 X 1 1/2	100
SF410012	10-24 X 1 1/4	100	SF431017	5/16-18 X 1 3/4	100
SF410015	10-24 X 1 1/2	100	SF431020	5/16-18 X 2	100
SF410020	10-24 X 2	100	SF431025	5/16-18 X 2 1/2	100
SF411002	10-32 X 1/4	100	SF431030	5/16-18 X 3	100
SF411004	10-32 X 3/8	100	SF437005	3/8-16 X 1/2	100
SF411005	10-32 X 1/2	100	SF437007	3/8-16 X 3/4	100
SF411006	10-32 X 5/8	100	SF437008	3/8-16 X 7/8	100
SF411007	10-32 X 3/4	100	SF437010	3/8-16 X 1	100
SF411010	10-32 X 1	100	SF437012	3/8-16 X 1 1/4	100
SF411012	10-32 X 1 1/4	100	SF437014	3/8-16 X 1 3/8	100
SF411015	10-32 X 1 1/2	100	SF437015	3/8-16 X 1 1/2	100
SF411017	10-32 X 1 3/4	100	SF437017	3/8-16 X 1 3/4	100
SF425004	1/4-20 X 3/8	100	SF437020	3/8-16 X 2	100

AUTRES DIMENSIONS DISPONIBLES / OTHER DIMENSIONS ARE AVAILABLE



Tel.: (819) 346-2903 / (888) 345-2903 Fax.: (819) 346-3389

Email: distributeur@boulonstrie.com

B-40

VIS À TÊTE FRAISÉE
À 6 PANS CREUX
GROS FILETS

SS-304
18-8

FLAT HEAD SOCKET
CAP SCREWS
NATIONAL COARSE

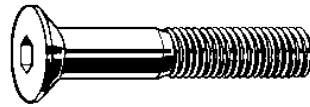

NOTRE CODE	DESCRIPTION	QTÉ/BTE	NOTRE CODE	DESCRIPTION	QTÉ/BTE
OUR CODE	DESCRIPTION	QTY/BOX	OUR CODE	DESCRIPTION	QTY/BOX
SF437022	3/8-16 X 2 1/4	50	SF450017	1/2-13 X 1 3/4	50
SF437025	3/8-16 X 2 1/2	50	SF450020	1/2-13 X 2	50
SF437027	3/8-16 X 2 3/4	50	SF450025	1/2-13 X 2 1/2	50
SF437030	3/8-16 X 3	50	SF450035	1/2-13 X 3 1/2	50
SF450007	1/2-13 X 3/4	50	SF462015	5/8-11 X 1 1/2	25
SF450010	1/2-13 X 1	50	SF462017	5/8-11 X 1 3/4	25
SF450012	1/2-13 X 1 1/4	50	SF462025	5/8-11 X 2 1/2	25
SF450015	1/2-13 X 1 1/2	50	SF475025	3/4-10 X 2 1/2	20

AUTRES DIMENSIONS DISPONIBLES / OTHER DIMENSIONS ARE AVAILABLE

AUSSI DISPONIBLE / ALSO AVAILABLE

ACIER INOXYDABLE SS-316 STAINLESS STEEL



Tel.: (819) 346-2903 / (888) 345-2903 Fax.: (819) 346-3389

Email: distributeur@boulonsestrie.com

B-41

VIS À TÊTE PLATE
À 6 PANS CREUX
GROS FILETS

GRADE 10.9
NOIR / BARE

FLAT HEAD SOCKET
CAP SCREWS
NATIONAL COARSE

MÉTRIQUE DIN 7991 METRIC

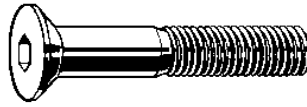

NOTRE CODE	DESCRIPTION	QTÉ/BTE	NOTRE CODE	DESCRIPTION	QTÉ/BTE
OUR CODE	DESCRIPTION	QTY/BOX	OUR CODE	DESCRIPTION	QTY/BOX
SF303006	M3 X .50 X 6	100	SF306010	M6 X 1.00 X 10	100
SF303008	M3 X .50 X 8	100	SF306012	M6 X 1.00 X 12	100
SF303010	M3 X .50 X 10	100	*****	M6 X 1.00 X 14	100
SF303012	M3 X .50 X 12	100	*****	M6 X 1.00 X 15	100
SF303016	M3 X .50 X 16	100	SF306016	M6 X 1.00 X 16	100
SF303020	M3 X .50 X 20	100	SF306018	M6 X 1.00 X 18	100
SF303025	M3 X .50 X 25	100	SF306020	M6 X 1.00 X 20	100
SF304008	M4 X .70 X 8	100	SF306025	M6 X 1.00 X 25	100
SF304010	M4 X .70 X 10	100	SF306030	M6 X 1.00 X 30	100
SF304012	M4 X .70 X 12	100	SF306035	M6 X 1.00 X 35	100
SF304016	M4 X .70 X 16	100	SF306040	M6 X 1.00 X 40	100
SF304020	M4 X .70 X 20	100	*****	M6 X 1.00 X 45	100
SF304025	M4 X .70 X 25	100	*****	M6 X 1.00 X 50	100
SF304030	M4 X .70 X 30	100	SF308010	M8 X 1.25 X 10	50
SF304035	M4 X .70 X 35	100	SF308012	M8 X 1.25 X 12	50
SF305008	M5 X .80 X 8	100	*****	M8 X 1.25 X 15	50
SF305010	M5 X .80 X 10	100	SF308016	M8 X 1.25 X 16	50
SF305012	M5 X .80 X 12	100	SF308018	M8 X 1.25 X 18	50
SF305016	M5 X .80 X 16	100	SF308020	M8 X 1.25 X 20	50
SF305020	M5 X .80 X 20	100	SF308025	M8 X 1.25 X 25	50
SF305025	M5 X .80 X 25	100	SF308030	M8 X 1.25 X 30	50
SF305030	M5 X .80 X 30	100	SF308035	M8 X 1.25 X 35	50
SF305035	M5 X .80 X 35	100	SF308040	M8 X 1.25 X 40	50
SF305040	M5 X .80 X 40	100	*****	M8 X 1.25 X 45	-
SF305050	M5 X .80 X 50	100	SF308050	M8 X 1.25 X 50	50
SF306008	M6 X 1.00 X 8	100	*****	M8 X 1.25 X 55	-

AUTRES DIMENSIONS DISPONIBLES/OTHER DIMENSIONS ARE AVAILABLE



Tel.: (819) 346-2903 / (888) 345-2903 Fax.: (819) 346-3389

Email: distributeur@boulonstrie.com

VIS À TÊTE PLATE
À 6 PANS CREUX
GROS FILETS

GRADE 10.9
NOIR / BARE

FLAT HEAD SOCKET
CAP SCREWS
NATIONAL COARSE

MÉTRIQUE DIN 7991 METRIC

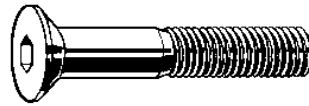

NOTRE CODE	DESCRIPTION	QTÉ/BTE	NOTRE CODE	DESCRIPTION	QTÉ/BTE
OUR CODE	DESCRIPTION	QTY/BOX	OUR CODE	DESCRIPTION	QTY/BOX
SF308060	M8 X 1.25 X 60	50	SF312045	M12 X 1.75 X 45	25
SF308070	M8 X 1.25 X 70	50	SF312050	M12 X 1.75 X 50	25
SF310012	M10 X 1.50 X 12	25	*****	M12 X 1.75 X 55	25
*****	M10 X 1.50 X 15	25	SF312060	M12 X 1.75 X 60	25
*****	M10 X 1.50 X 14	25	SF312070	M12 X 1.75 X 70	25
SF310016	M10 X 1.50 X 16	25	SF312080	M12 X 1.75 X 80	25
*****	M10 X 1.50 X 18	25	*****	M12 X 1.75 X 90	25
SF310020	M10 X 1.50 X 20	25	*****	M12 X 1.75 X 100	25
SF310025	M10 X 1.50 X 25	25	SF316025	M16 X 2.00 X 25	20
SF310030	M10 X 1.50 X 30	25	SF316030	M16 X 2.00 X 30	20
SF310035	M10 X 1.50 X 35	25	*****	M16 X 2.00 X 35	20
SF310040	M10 X 1.50 X 40	25	SF316040	M16 X 2.00 X 40	20
*****	M10 X 1.50 X 45	25	*****	M16 X 2.00 X 45	20
SF310050	M10 X 1.50 X 50	25	SF316050	M16 X 2.00 X 50	20
*****	M10 X 1.50 X 55	25	*****	M16 X 2.00 X 55	20
SF310060	M10 X 1.50 X 60	25	*****	M16 X 2.00 X 60	20
*****	M10 X 1.50 X 70	25	SF316070	M16 X 2.00 X 70	20
SF310075	M10 X 1.50 X 75	25	*****	M16 X 2.00 X 80	20
*****	M10 X 1.50 X 80	25	*****	M16 X 2.00 X 90	20
*****	M10 X 1.50 X 90	25	*****	M16 X 2.00 X 100	20
*****	M10 X 1.50 X 100	25	*****	M20 X 2.50 X 35	15
SF312020	M12 X 1.75 X 20	25	*****	M20 X 2.50 X 40	15
SF312025	M12 X 1.75 X 25	25	*****	M20 X 2.50 X 45	15
SF312030	M12 X 1.75 X 30	25	SF320050	M20 X 2.50 X 50	15
SF312035	M12 X 1.75 X 35	25	*****	M20 X 2.50 X 55	15
SF312040	M12 X 1.75 X 40	25	SF320060	M20 X 2.50 X 60	15

AUTRES DIMENSIONS DISPONIBLES/OTHER DIMENSIONS ARE AVAILABLE



Tel.: (819) 346-2903 / (888) 345-2903 Fax.: (819) 346-3389

Email: distributeur@boulonstrie.com

**VIS À TÊTE PLATE
À 6 PANS CREUX
GROS FILETS**

**GRADE 10.9
NOIR / BARE**

**FLAT HEAD SOCKET
CAP SCREWS
NATIONAL COARSE**

MÉTRIQUE DIN 7991 METRIC

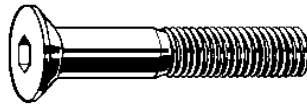

NOTRE CODE	DESCRIPTION	QTÉ/BTE	NOTRE CODE	DESCRIPTION	QTÉ/BTE
OUR CODE	DESCRIPTION	QTY/BOX	OUR CODE	DESCRIPTION	QTY/BOX
SF320070	M20 X 2.50 X 70	15	*****	M20 X 2.50 X 90	15
*****	M20 X 2.50 X 80	15	*****	M20 X 2.50 X 100	15

AUTRES DIMENSIONS DISPONIBLES/OTHER DIMENSIONS ARE AVAILABLE

AUSSI DISPONIBLE / ALSO AVAILABLE

**VIS À TÊTE FRAISÉE À 6 PANS CREUX,
MÉTRIQUE, DIN 7991, A2 (304).**

**FLAT HEAD SOCKET CAP SCREWS,
METRIC, DIN 7991, A2 (304).**



Tel.: (819) 346-2903 / (888) 345-2903 Fax.: (819) 346-3389

Email: distributeur@boulonsestrie.com

B-44

VIS DE PRESSION
 À 6 PANS CREUX
 GROS FILETS

NOIR / BARE
 ALLOY STEEL

SOCKET SET SCREWS
 CUP POINT
 NATIONAL COARSE

LA FINITION PLAQUÉE ZINC
 EST DISPONIBLE
 SUR DEMANDE

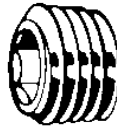

ZINC PLATED IS
 AVAILABLE ON REQUEST

NOTRE CODE	DESCRIPTION	QTÉ/BTE	NOTRE CODE	DESCRIPTION	QTÉ/BTE
OUR CODE	DESCRIPTION	QTY/BOX	OUR CODE	DESCRIPTION	QTY/BOX
*****	2-56 X 1/16	100	SS104062	4-40 X 5/8	100
*****	2-56 X 3/32	100	*****	4-40 X 3/4	SEMI-STD
*****	2-56 X 1/8	100	*****	4-40 X 7/8	SEMI-STD
*****	2-56 X 5/32	SEMI-STD	*****	4-40 X 1	SEMI-STD
SS102018	2-56 X 3/16	100	SS105012	5-40 X 1/8	100
SS102025	2-56 X 1/4	100	SS105018	5-40 X 3/16	100
*****	2-56 X 5/16	SEMI-STD	SS105025	5-40 X 1/4	100
*****	2-56 X 3/8	SEMI-STD	SS105031	5-40 X 5/16	100
*****	2-56 X 1/2	SEMI-STD	SS105037	5-40 X 3/8	100
*****	2-56 X 5/8	SEMI-STD	*****	5-40 X 7/16	SEMI-STD
*****	2-56 X 3/4	SEMI-STD	SS105050	5-40 X 1/2	100
*****	3-48 X 1/16	SEMI-STD	SS105062	5-40 X 5/8	100
*****	3-48 X 5/32	SEMI-STD	SS105075	5-40 X 3/4	100
*****	3-48 X 3/32	100	*****	5-40 X 7/8	SEMI-STD
*****	3-48 X 1/8	100	*****	5-40 X 1	SEMI-STD
SS103018	3-48 X 3/16	100	SS106012	6-32 X 1/8	100
SS103025	3-48 X 1/4	100	SS106018	6-32 X 3/16	100
*****	3-48 X 5/16	SEMI-STD	SS106025	6-32 X 1/4	100
*****	3-48 X 3/8	SEMI-STD	SS106031	6-32 X 5/16	100
*****	3-48 X 1/2	SEMI-STD	SS106037	6-32 X 3/8	100
*****	3-48 X 5/8	SEMI-STD	SS106043	6-32 X 7/16	100
SS104012	4-40 X 1/8	100	SS106050	6-32 X 1/2	100
SS104018	4-40 X 3/16	100	SS106062	6-32 X 5/8	100
SS104025	4-40 X 1/4	100	SS106075	6-32 X 3/4	100
*****	4-40 X 5/16	100	SS106087	6-32 X 7/8	100
SS104037	4-40 X 3/8	100	SS106100	6-32 X 1	100
*****	4-40 X 7/16	SEMI-STD	*****	6-32 X 1 1/4	SEMI-STD
SS104050	4-40 X 1/2	100	*****	6-32 X 1 1/2	SEMI-STD

SEMI-STD PLUSIEURS QUANTITÉS DISPONIBLES / SEMI-STD PACKAGING ANY QUANTITY



Tel.: (819) 346-2903 / (888) 345-2903 Fax.: (819) 346-3389
 Email: distributeur@boulonsestrie.com

B-45

LA FINITION PLAQUÉE ZINC
EST DISPONIBLE
SUR DEMANDE



ZINC PLATED IS
AVAILABLE ON REQUEST

NOTRE CODE	DESCRIPTION	QTÉ/BTE	NOTRE CODE	DESCRIPTION	QTÉ/BTE
OUR CODE	DESCRIPTION	QTY/BOX	OUR CODE	DESCRIPTION	QTY/BOX
*****	6-32 X 1 3/4	SEMI-STD	SS110125	10-24 X 1 1/4	100
*****	6-32 X 2	SEMI-STD	SS110150	10-24 X 1 1/2	SEMI-STD
SS108012	8-32 X 1/8	100	*****	10-24 X 1 3/4	SEMI-STD
SS108018	8-32 X 3/16	100	*****	10-24 X 2	SEMI-STD
SS108025	8-32 X 1/4	100	*****	10-24 X 2 1/2	SEMI-STD
SS108031	8-32 X 5/16	100	*****	12-24 X 3/16	SEMI-STD
SS108037	8-32 X 3/8	100	*****	12-24 X 1/4	SEMI-STD
SS108043	8-32 X 7/16	100	*****	12-24 X 5/16	SEMI-STD
SS108050	8-32 X 1/2	100	*****	12-24 X 3/8	SEMI-STD
SS108062	8-32 X 5/8	100	*****	12-24 X 1/2	SEMI-STD
SS108075	8-32 X 3/4	100	*****	12-24 X 5/8	SEMI-STD
SS108087	8-32 X 7/8	100	*****	12-24 X 3/4	SEMI-STD
SS108100	8-32 X 1	100	*****	12-24 X 1	SEMI-STD
*****	8-32 X 1 1/4	SEMI-STD	SS125018	1/4-20 X 3/16	100
*****	8-32 X 1 1/2	SEMI-STD	SS125025	1/4-20 X 1/4	100
*****	8-32 X 1 3/4	SEMI-STD	SS125031	1/4-20 X 5/16	100
*****	8-32 X 2	SEMI-STD	SS125037	1/4-20 X 3/8	100
*****	10-24 X 1/8	SEMI-STD	*****	1/4-20 X 7/16	100
SS110018	10-24 X 3/16	100	SS125050	1/4-20 X 1/2	100
SS110025	10-24 X 1/4	100	SS125062	1/4-20 X 5/8	100
SS110031	10-24 X 5/16	100	SS125075	1/4-20 X 3/4	100
SS110037	10-24 X 3/8	100	SS125087	1/4-20 X 7/8	100
SS110043	10-24 X 7/16	100	SS125100	1/4-20 X 1	100
SS110050	10-24 X 1/2	100	*****	1/4-20 X 1 1/8	SEMI-STD
SS110062	10-24 X 5/8	100	SS125125	1/4-20 X 1 1/4	100
SS110075	10-24 X 3/4	100	SS125150	1/4-20 X 1 1/2	100
SS110087	10-24 X 7/8	100	SS125175	1/4-20 X 1 3/4	100
SS110100	10-24 X 1	100	SS125200	1/4-20 X 2	100

SEMI-STD PLUSIEURS QUANTITÉS DISPONIBLES / SEMI-STD PACKAGING ANY QUANTITY



Tel.: (819) 346-2903 / (888) 345-2903 Fax.: (819) 346-3389
Email: distributeur@boulonsestrie.com

VIS DE PRESSION
À 6 PANS CREUX
GROS FILETS

NOIR / BARE
ALLOY STEEL

SOCKET SET SCREWS
CUP POINT
NATIONAL COARSE

LA FINITION PLAQUÉE ZINC
EST DISPONIBLE
SUR DEMANDE



ZINC PLATED IS
AVAILABLE ON REQUEST

NOTRE CODE	DESCRIPTION	QTÉ/BTE	NOTRE CODE	DESCRIPTION	QTÉ/BTE
OUR CODE	DESCRIPTION	QTY/BOX	OUR CODE	DESCRIPTION	QTY/BOX
*****	1/4-20 X 2 1/4	SEMI-STD	SS137087	3/8-16 X 7/8	100
SS125250	1/4-20 X 2 1/2	SEMI-STD	SS137100	3/8-16 X 1	100
*****	1/4-20 X 2 3/4	SEMI-STD	SS137125	3/8-16 X 1 1/4	100
*****	1/4-20 X 3	SEMI-STD	SS137150	3/8-16 X 1 1/2	100
SS131025	5/16-18 X 1/4	100	SS137175	3/8-16 X 1 3/4	100
SS131031	5/16-18 X 5/16	100	SS137200	3/8-16 X 2	100
SS131037	5/16-18 X 3/8	100	*****	3/8-16 X 2 1/4	SEMI-STD
SS131043	5/16-18 X 7/16	100	SS137250	3/8-16 X 2 1/2	100
SS131050	5/16-18 X 1/2	100	SS137275	3/8-16 X 2 3/4	SEMI-STD
SS131062	5/16-18 X 5/8	100	*****	3/8-16 X 3	SEMI-STD
SS131075	5/16-18 X 3/4	100	*****	3/8-16 X 3 1/2	SEMI-STD
SS131087	5/16-18 X 7/8	100	*****	3/8-16 X 4	SEMI-STD
SS131100	5/16-18 X 1	100	SS143037	7/16-14 X 3/8	100
SS131125	5/16-18 X 1 1/4	100	*****	7/16-14 X 7/16	100
SS131150	5/16-18 X 1 1/2	100	SS143050	7/16-14 X 1/2	100
SS131175	5/16-18 X 1 3/4	100	SS143062	7/16-14 X 5/8	100
SS131200	5/16-18 X 2	100	SS143075	7/16-14 X 3/4	100
SS131225	5/16-18 X 2 1/4	SEMI-STD	SS143087	7/16-14 X 7/8	100
*****	5/16-18 X 2 1/2	SEMI-STD	SS143100	7/16-14 X 1	100
*****	5/16-18 X 2 3/4	SEMI-STD	SS143125	7/16-14 X 1 1/4	100
SS131300	5/16-18 X 3	SEMI-STD	SS143150	7/16-14 X 1 1/2	100
SS137025	3/8-16 X 1/4	100	SS143175	7/16-14 X 1 3/4	SEMI-STD
SS137031	3/8-16 X 5/16	100	SS143200	7/16-14 X 2	100
SS137037	3/8-16 X 3/8	100	*****	7/16-14 X 2 1/4	SEMI-STD
SS137043	3/8-16 X 7/16	100	*****	7/16-14 X 2 1/2	SEMI-STD
SS137050	3/8-16 X 1/2	100	*****	7/16-14 X 2 3/4	SEMI-STD
SS137062	3/8-16 X 5/8	100	*****	7/16-14 X 3	SEMI-STD
SS137075	3/8-16 X 3/4	100	SS150037	1/2-13 X 3/8	100

SEMI-STD PLUSIEURS QUANTITÉS DISPONIBLES / SEMI-STD PACKAGING ANY QUANTITY



Tel.: (819) 346-2903 / (888) 345-2903 Fax.: (819) 346-3389
Email: distributeur@boulonstrie.com

B-47

VIS DE PRESSION
À 6 PANS CREUX
GROS FILETS

NOIR / BARE
ALLOY STEEL

SOCKET SET SCREWS
CUP POINT
NATIONAL COARSE

LA FINITION PLAQUÉE ZINC
EST DISPONIBLE
SUR DEMANDE



ZINC PLATED IS
AVAILABLE ON REQUEST

NOTRE CODE	DESCRIPTION	QTÉ/BTE	NOTRE CODE	DESCRIPTION	QTÉ/BTE
OUR CODE	DESCRIPTION	QTY/BOX	OUR CODE	DESCRIPTION	QTY/BOX
SS150043	1/2-13 X 7/16	100	SS162200	5/8-11 X 2	50
SS150050	1/2-13 X 1/2	100	*****	5/8-11 X 2 1/4	SEMI-STD
SS150062	1/2-13 X 5/8	100	SS162250	5/8-11 X 2 1/2	50
SS150075	1/2-13 X 3/4	100	*****	5/8-11 X 2 3/4	SEMI-STD
SS150087	1/2-13 X 7/8	100	SS162300	5/8-11 X 3	50
SS150100	1/2-13 X 1	100	*****	5/8-11 X 3 1/4	SEMI-STD
SS150125	1/2-13 X 1 1/4	100	SS162350	5/8-11 X 3 1/2	SEMI-STD
SS150150	1/2-13 X 1 1/2	100	SS162400	5/8-11 X 4	SEMI-STD
SS150175	1/2-13 X 1 3/4	50	*****	5/8-11 X 4 1/2	SEMI-STD
SS150200	1/2-13 X 2	50	*****	5/8-11 X 5	SEMI-STD
*****	1/2-13 X 2 1/4	SEMI-STD	SS162600	5/8-11 X 6	SEMI-STD
SS150250	1/2-13 X 2 1/2	50	SS175062	3/4-10 X 5/8	50
*****	1/2-13 X 2 3/4	SEMI-STD	SS175075	3/4-10 X 3/4	50
SS150300	1/2-13 X 3	50	*****	3/4-10 X 7/8	SEMI-STD
*****	1/2-13 X 3 1/2	SEMI-STD	SS175100	3/4-10 X 1	50
*****	1/2-13 X 4	SEMI-STD	SS175125	3/4-10 X 1 1/4	50
*****	1/2-13 X 4 1/2	SEMI-STD	SS175150	3/4-10 X 1 1/2	50
*****	1/2-13 X 5	SEMI-STD	SS175175	3/4-10 X 1 3/4	25
*****	1/2-13 X 5 1/2	SEMI-STD	SS175200	3/4-10 X 2	25
*****	1/2-13 X 6	SEMI-STD	*****	3/4-10 X 2 1/4	SEMI-STD
SS162050	5/8-11 X 1/2	50	SS175250	3/4-10 X 2 1/2	25
SS162062	5/8-11 X 5/8	50	SS175300	3/4-10 X 3	25
SS162075	5/8-11 X 3/4	50	SS175350	3/4-10 X 3 1/2	SEMI-STD
*****	5/8-11 X 7/8	50	*****	3/4-10 X 4	SEMI-STD
SS162100	5/8-11 X 1	50	*****	3/4-10 X 4 1/2	SEMI-STD
SS162125	5/8-11 X 1 1/4	50	SS175500	3/4-10 X 5	SEMI-STD
SS162150	5/8-11 X 1 1/2	50	SS187087	7/8-9 X 7/8	25
SS162175	5/8-11 X 1 3/4	50	SS187100	7/8-9 X 1	25

SEMI-STD PLUSIEURS QUANTITÉS DISPONIBLES / SEMI-STD PACKAGING ANY QUANTITY



Tel.: (819) 346-2903 / (888) 345-2903 Fax.: (819) 346-3389
Email: distributeur@boulonsestrie.com

B-48

LA FINITION PLAQUÉE ZINC
 EST DISPONIBLE
 SUR DEMANDE

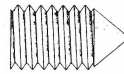
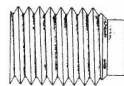
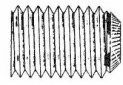
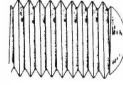
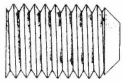

ZINC PLATED IS
 AVAILABLE ON REQUEST

NOTRE CODE	DESCRIPTION	QTÉ/BTE	NOTRE CODE	DESCRIPTION	QTÉ/BTE
OUR CODE	DESCRIPTION	QTY/BOX	OUR CODE	DESCRIPTION	QTY/BOX
***** SS187150	7/8-9 X 1 1/4 7/8-9 X 1 1/2	SEMI-STD 25	***** *****	1 1/8-7 X 2 1/2 1 1/8-7 X 3	SEMI-STD SEMI-STD
***** SS187200	7/8-9 X 1 3/4 7/8-9 X 2	SEMI-STD 25	***** *****	1 1/4-7 X 1 1 1/4-7 X 1 1/4	SEMI-STD SEMI-STD
***** SS187250	7/8-9 X 2 1/4 7/8-9 X 2 1/2	SEMI-STD 25	***** *****	1 1/4-7 X 1 1/2 1 1/4-7 X 2	SEMI-STD SEMI-STD
***** SS187300	7/8-9 X 3 7/8-9 X 3 1/2	SEMI-STD 25	***** *****	1 1/4-7 X 2 1/2 1 1/4-7 X 3	SEMI-STD SEMI-STD
***** *****	7/8-9 X 4	SEMI-STD	***** *****	1 1/4-7 X 3 1/2 1 1/4-7 X 4	SEMI-STD SEMI-STD
SS190100	1-8 X 1	25	***** *****	1 1/2-6 X 1 1/2 1 1/2-6 X 2	SEMI-STD SEMI-STD
***** SS190150	1-8 X 1 1/4 1-8 X 1 1/2	SEMI-STD 25	***** *****	1 1/2-6 X 2 1/2 1 1/2-6 X 3	SEMI-STD SEMI-STD
***** SS190200	1-8 X 1 3/4 1-8 X 2	SEMI-STD 25	***** *****	1 1/2-6 X 3 1/2 1 1/2-6 X 4	SEMI-STD SEMI-STD
***** SS190275	1-8 X 2 1/4 1-8 X 2 1/2	SEMI-STD 25	AUSSI DISPONIBLE/ ALSO AVAILABLE CONE PT  HALF DOG  KNURLED PT  OVAL PT  FLAT PT 		
***** SS190300	1-8 X 2 3/4 1-8 X 3	SEMI-STD 25			
***** *****	1-8 X 3 1/2 1-8 X 4	SEMI-STD SEMI-STD			
***** *****	1-8 X 4 1/2 1-8 X 5	SEMI-STD SEMI-STD			
***** *****	1-8 X 6	SEMI-STD			
***** *****	1 1/8-7 X 1 1 1/8-7 X 1 1/4	SEMI-STD SEMI-STD			
***** *****	1 1/8-7 X 1 1/2 1 1/8-7 X 1 3/4	SEMI-STD SEMI-STD			
***** *****	1 1/8-7 X 2	SEMI-STD			

SEMI-STD PLUSIEURS QUANTITÉS DISPONIBLES / SEMI-STD PACKAGING ANY QUANTITY



VIS DE PRESSION
À 6 PANS CREUX
FILETS FINS

NOIR / BARE
ALLOY STEEL

SOCKET SET SCREWS
CUP POINT
NATIONAL FINE

LA FINITION PLAQUÉE ZINC
EST DISPONIBLE
SUR DEMANDE

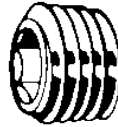

ZINC PLATED IS
AVAILABLE ON REQUEST

NOTRE CODE	DESCRIPTION	QTÉ/BTE	NOTRE CODE	DESCRIPTION	QTÉ/BTE
OUR CODE	DESCRIPTION	QTY/BOX	OUR CODE	DESCRIPTION	QTY/BOX
*****	0-80 X 1/16	100	*****	4-48 X 7/16	SEMI-STD
*****	0-80 X 5/32	SEMI-STD	*****	4-48 X 1/2	SEMI-STD
*****	0-80 X 3/32	100	*****	4-48 X 5/8	SEMI-STD
*****	0-80 X 1/8	100	SS205012	5-44 X 1/8	100
*****	0-80 X 3/16	100	SS205018	5-44 X 3/16	100
*****	0-80 X 1/4	100	SS205025	5-44 X 1/4	100
*****	0-80 X 5/16	SEMI-STD	*****	5-44 X 5/16	SEMI-STD
*****	0-80 X 3/8	SEMI-STD	*****	5-44 X 3/8	SEMI-STD
*****	1-72 X 1/16	100	SS206012	6-40 X 1/8	100
*****	1-72 X 3/32	100	SS206018	6-40 X 3/16	100
*****	1-72 X 1/8	100	SS206025	6-40 X 1/4	100
*****	1-72 X 3/16	100	SS206031	6-40 X 5/16	100
*****	1-72 X 1/4	100	SS206037	6-40 X 3/8	100
*****	2-64 X 3/32	SEMI-STD	SS208012	8-36 X 1/8	100
*****	2-64 X 1/8	SEMI-STD	SS208018	8-36 X 3/16	100
*****	2-64 X 3/16	SEMI-STD	SS208025	8-36 X 1/4	100
*****	2-64 X 1/4	SEMI-STD	SS208031	8-36 X 5/16	100
*****	3-56 X 1/8	SEMI-STD	*****	8-36 X 3/8	100
*****	3-56 X 3/16	SEMI-STD	SS208050	8-36 X 1/2	100
*****	3-56 X 1/4	SEMI-STD	SS210012	10-32 X 1/8	SEMI-STD
*****	3-56 X 5/16	SEMI-STD	SS210018	10-32 X 3/16	100
*****	3-56 X 3/8	SEMI-STD	SS210025	10-32 X 1/4	100
*****	4-48 X 1/8	100	SS210031	10-32 X 5/16	100
*****	4-48 X 3/32	SEMI-STD	SS210037	10-32 X 3/8	100
SS204018	4-48 X 3/16	100	SS210043	10-32 X 7/16	100
*****	4-48 X 1/4	100	SS210050	10-32 X 1/2	100
*****	4-48 X 5/16	SEMI-STD	SS210062	10-32 X 5/8	100
*****	4-48 X 3/8	100	SS210075	10-32 X 3/4	100

SEMI-STD PLUSIEURS QUANTITÉS DISPONIBLES / SEMI-STD PACKAGING ANY QUANTITY



Tel.: (819) 346-2903 / (888) 345-2903 Fax.: (819) 346-3389

Email: distributeur@boulonsestrie.com

B-50

VIS DE PRESSION
À 6 PANS CREUX
FILETS FINS

NOIR / BARE
ALLOY STEEL

SOCKET SET SCREWS
CUP POINT
NATIONAL FINE

LA FINITION PLAQUÉE ZINC
EST DISPONIBLE
SUR DEMANDE



ZINC PLATED IS
AVAILABLE ON REQUEST

NOTRE CODE	DESCRIPTION	QTÉ/BTE	NOTRE CODE	DESCRIPTION	QTÉ/BTE
OUR CODE	DESCRIPTION	QTY/BOX	OUR CODE	DESCRIPTION	QTY/BOX
SS210087	10-32 X 7/8	SEMI-STD	SS231037	5/16-24 X 3/8	100
SS210100	10-32 X 1	100	*****	5/16-24 X 7/16	100
SS210125	10-32 X 1 1/4	100	SS231050	5/16-24 X 1/2	100
SS210150	10-32 X 1 1/2	SEMI-STD	*****	5/16-24 X 5/8	100
SS210175	10-32 X 1 3/4	SEMI-STD	SS231075	5/16-24 X 3/4	100
*****	10-32 X 2	SEMI-STD	*****	5/16-24 X 7/8	SEMI-STD
*****	10-32 X 2 1/2	SEMI-STD	SS231100	5/16-24 X 1	100
*****	12-28 X 1/4	SEMI-STD	SS231125	5/16-24 X 1 1/4	100
*****	12-28 X 3/8	SEMI-STD	SS231150	5/16-24 X 1 1/2	SEMI-STD
*****	12-28 X 1/2	SEMI-STD	SS231175	5/16-24 X 1 3/4	SEMI-STD
SS225018	1/4-28 X 3/16	100	*****	5/16-24 X 2	SEMI-STD
SS225025	1/4-28 X 1/4	100	*****	5/16-24 X 2 1/4	SEMI-STD
SS225031	1/4-28 X 5/16	100	*****	5/16-24 X 2 1/2	SEMI-STD
SS225037	1/4-28 X 3/8	100	SS231300	5/16-24 X 3	SEMI-STD
SS225043	1/4-28 X 7/16	100	SS237025	3/8-24 X 1/4	100
SS225050	1/4-28 X 1/2	100	SS237031	3/8-24 X 5/16	100
SS225062	1/4-28 X 5/8	100	SS237037	3/8-24 X 3/8	100
SS225075	1/4-28 X 3/4	100	SS237043	3/8-24 X 7/16	100
*****	1/4-28 X 7/8	SEMI-STD	SS237050	3/8-24 X 1/2	100
SS225100	1/4-28 X 1	100	SS237062	3/8-24 X 5/8	100
SS225125	1/4-28 X 1 1/4	100	SS237075	3/8-24 X 3/4	100
SS225150	1/4-28 X 1 1/2	SEMI-STD	SS237087	3/8-24 X 7/8	SEMI-STD
*****	1/4-28 X 1 3/4	SEMI-STD	SS237100	3/8-24 X 1	100
*****	1/4-28 X 2	SEMI-STD	SS237125	3/8-24 X 1 1/4	100
*****	1/4-28 X 2 1/2	SEMI-STD	SS237150	3/8-24 X 1 1/2	100
*****	1/4-28 X 3	SEMI-STD	SS237175	3/8-24 X 1 3/4	SEMI-STD
SS231025	5/16-24 X 1/4	100	*****	3/8-24 X 2	SEMI-STD
SS231031	5/16-24 X 5/16	100	*****	3/8-24 X 2 1/4	SEMI-STD

SEMI-STD PLUSIEURS QUANTITÉS DISPONIBLES / SEMI-STD PACKAGING ANY QUANTITY



Tel.: (819) 346-2903 / (888) 345-2903 Fax.: (819) 346-3389

Email: distributeur@boulonstrie.com

B-51

VIS DE PRESSION
À 6 PANS CREUX
FILETS FINS

NOIR / BARE
ALLOY STEEL

SOCKET SET SCREWS
CUP POINT
NATIONAL FINE

LA FINITION PLAQUÉE ZINC
EST DISPONIBLE
SUR DEMANDE



ZINC PLATED IS
AVAILABLE ON REQUEST

NOTRE CODE	DESCRIPTION	QTÉ/BTE	NOTRE CODE	DESCRIPTION	QTÉ/BTE
OUR CODE	DESCRIPTION	QTY/BOX	OUR CODE	DESCRIPTION	QTY/BOX
*****	3/8-24 X 2 1/2	SEMI-STD	*****	1/2-20 X 4	SEMI-STD
*****	3/8-24 X 3	SEMI-STD	SS262050	5/8-11 X 1/2	SEMI-STD
SS243037	7/16-20 X 3/8	100	SS262062	5/8-18 X 5/8	50
*****	7/16-20 X 7/16	100	*****	5/8-18 X 3/4	SEMI-STD
SS243050	7/16-20 X 1/2	100	*****	5/8-18 X 7/8	SEMI-STD
*****	7/16-20 X 5/8	SEMI-STD	SS262100	5/8-18 X 1	50
SS243075	7/16-20 X 3/4	SEMI-STD	SS262125	5/8-18 X 1 1/4	SEMI-STD
*****	7/16-20 X 7/8	SEMI-STD	*****	5/8-18 X 1 1/2	SEMI-STD
SS243100	7/16-20 X 1	SEMI-STD	*****	5/8-18 X 1 3/4	SEMI-STD
*****	7/16-20 X 1 1/4	SEMI-STD	*****	5/8-18 X 2	SEMI-STD
SS243150	7/16-20 X 1 1/2	SEMI-STD	*****	5/8-18 X 2 1/2	SEMI-STD
*****	7/16-20 X 1 3/4	SEMI-STD	*****	5/8-18 X 3	SEMI-STD
*****	7/16-20 X 2	SEMI-STD	*****	5/8-18 X 4	SEMI-STD
*****	7/16-20 X 2 1/2	SEMI-STD	SS275075	3/4-16 X 3/4	SEMI-STD
*****	7/16-20 X 3	SEMI-STD	SS275100	3/4-16 X 1	SEMI-STD
*****	1/2-20 X 3/8	SEMI-STD	*****	3/4-16 X 1 1/4	SEMI-STD
SS250050	1/2-20 X 1/2	SEMI-STD	*****	3/4-16 X 1 1/2	SEMI-STD
SS250062	1/2-20 X 5/8	100	*****	3/4-16 X 1 3/4	SEMI-STD
SS250075	1/2-20 X 3/4	100	*****	3/4-16 X 2	SEMI-STD
*****	1/2-20 X 7/8	SEMI-STD	*****	3/4-16 X 2 1/4	SEMI-STD
SS250100	1/2-20 X 1	100	*****	3/4-16 X 2 1/2	SEMI-STD
*****	1/2-20 X 1 1/4	SEMI-STD	*****	3/4-16 X 3	SEMI-STD
*****	1/2-20 X 1 1/2	SEMI-STD	*****	3/4-16 X 4	SEMI-STD
*****	1/2-20 X 1 3/4	SEMI-STD	*****	7/8-14 X 1	SEMI-STD
*****	1/2-20 X 2	SEMI-STD	*****	7/8-14 X 1 1/4	SEMI-STD
*****	1/2-20 X 2 1/2	SEMI-STD	*****	7/8-14 X 1 1/2	SEMI-STD
*****	1/2-20 X 3	SEMI-STD	*****	7/8-14 X 2	SEMI-STD
*****	1/2-20 X 3 1/2	SEMI-STD	*****	7/8-14 X 2 1/2	SEMI-STD

SEMI-STD PLUSIEURS QUANTITÉS DISPONIBLES / SEMI-STD PACKAGING ANY QUANTITY



Tel.: (819) 346-2903 / (888) 345-2903 Fax.: (819) 346-3389

Email: distributeur@boulonstrie.com

B-52

VIS DE PRESSION
 À 6 PANS CREUX
 FILETS FINS

NOIR / BARE
 ALLOY STEEL

SOCKET SET SCREWS
 CUP POINT
 NATIONAL FINE

LA FINITION PLAQUÉE ZINC
 EST DISPONIBLE
 SUR DEMANDE



ZINC PLATED IS
 AVAILABLE ON REQUEST

NOTRE CODE	DESCRIPTION	QTÉ/BTE	NOTRE CODE	DESCRIPTION	QTÉ/BTE
OUR CODE	DESCRIPTION	QTY/BOX	OUR CODE	DESCRIPTION	QTY/BOX
*****	7/8-14 X 3	SEMI-STD	*****	1-14 X 2 1/2	SEMI-STD
*****	1-14 X 1	SEMI-STD	*****	1-14 X 3	SEMI-STD
*****	1-14 X 1 1/2	SEMI-STD	*****	1-14 X 4	SEMI-STD
*****	1-14 X 2	SEMI-STD			

SEMI-STD PACKAGING ANY QUANTITY / SEMI-STD PLUSIEURS QUANTITÉS DISPONIBLES

AUSSI DISPONIBLE

ALSO AVAILABLE

CONE PT

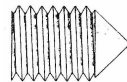

OVAL PT

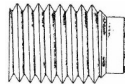

HALF DOG PT

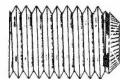

KNURLED PT

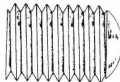

FLAT PT

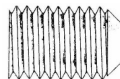

Tel.: (819) 346-2903 / (888) 345-2903 Fax.: (819) 346-3389

Email: distributeur@boulonsestrie.com

B-53

GROS FILETS
& FILETS FINS



NATIONAL COARSE
& NATIONAL FINE

NOTRE CODE	DESCRIPTION	QTÉ/BTE	NOTRE CODE	DESCRIPTION	QTÉ/BTE
OUR CODE	DESCRIPTION	QTY/BOX	OUR CODE	DESCRIPTION	QTY/BOX
SS402012	2-56 X 1/8	100	SS425062	1/4-20 X 5/8	100
SS402025	2-56 X 1/4	100	SS425075	1/4-20 X 3/4	100
SS404012	4-40 X 1/8	100	SS425087	1/4-20 X 7/8	100
SS404018	4-40 X 3/16	100	SS425100	1/4-20 X 1	100
SS404025	4-40 X 1/4	100	SS425200	1/4-20 X 2	100
SS406012	6-32 X 1/8	100	SS426025	1/4-28 X 1/4	100
SS406018	6-32 X 3/16	100	SS426031	1/4-28 X 5/16	100
SS406025	6-32 X 1/4	100	SS426037	1/4-28 X 3/8	100
SS406037	6-32 X 3/8	100	SS431025	5/16-18 X 1/4	100
SS408012	8-32 X 1/8	100	SS431031	5/16-18 X 5/16	100
SS408025	8-32 X 1/4	100	SS431037	5/16-18 X 3/8	100
SS408037	8-32 X 3/8	100	SS431050	5/16-18 X 1/2	100
SS408050	8-32 X 1/2	100	SS431062	5/16-18 X 5/8	100
SS408075	8-32 X 3/4	100	SS431075	5/16-18 X 3/4	100
SS410018	10-24 X 3/16	100	SS431100	5/16-18 X 1	100
SS410025	10-24 X 1/4	100	SS432037	5/16-24 X 3/8	100
SS410031	10-24 X 5/16	100	SS432050	5/16-24 X 1/2	100
SS410037	10-24 X 3/8	100	SS432125	5/16-24 X 1 1/4	100
SS410050	10-24 X 1/2	100	SS437037	3/8-16 X 3/8	100
SS410075	10-24 X 3/4	100	SS437050	3/8-16 X 1/2	100
SS411018	10-32 X 3/16	100	SS437075	3/8-16 X 3/4	100
SS411025	10-32 X 1/4	100	SS437087	3/8-16 X 7/8	100
SS411031	10-32 X 5/16	100	SS437100	3/8-16 X 1	100
SS411037	10-32 X 3/8	100	SS438025	3/8-24 X 1/4	100
SS411043	10-32 X 7/16	100	SS438037	3/8-24 X 3/8	100
SS411050	10-32 X 1/2	100	SS438225	3/8-24 X 2 1/4	100
SS425025	1/4-20 X 1/4	100	SS450037	1/2-13 X 3/8	50
SS425031	1/4-20 X 5/16	100	SS450050	1/2-13 X 1/2	50
SS425037	1/4-20 X 3/8	100	SS450062	1/2-13 X 5/8	50
SS425050	1/4-20 X 1/2	100	SS450075	1/2-13 X 3/4	50



VIS DE PRESSION
À 6 PANS CREUX

SS-304 / 18-8

SOCKET SET SCREWS
CUP POINT

GROS FILETS
& FILETS FINS



NATIONAL COARSE
& NATIONAL FINE

NOTRE CODE	DESCRIPTION	QTÉ/BTE	NOTRE CODE	DESCRIPTION	QTÉ/BTE
OUR CODE	DESCRIPTION	QTY/BOX	OUR CODE	DESCRIPTION	QTY/BOX
SS450100	1/2-13 X 1	50	SS462200	5/8-11 X 2	25
SS450150	1/2-13 X 1 1/2	50	SS475100	3/4-10 X 1	20
SS450175	1/2-13 X 1 3/4	50	SS475150	3/4-10 X 1 1/2	20
SS450200	1/2-13 X 2	50	SS487100	7/8-9 X 1	20
SS450250	1/2-13 X 1 1/2	50	SS487125	7/8-9 X 1 1/4	20
SS462075	5/8-11 X 3/4	25	SS487200	7/8-9 X 2	20
SS462100	5/8-11 X 1	25	SS490200	1-8 X 2	15
SS462150	5/8-11 X 1 1/2	25			

AUTRES DIMENSIONS DISPONIBLES/OTHER DIMENSIONS ARE AVAILABLE

AUSSI DISPONIBLE

ALSO AVAILABLE

SS 316



Tel.: (819) 346-2903 / (888) 345-2903 Fax.: (819) 346-3389

Email: distributeur@boulonsestrie.com

B-55

MÉTRIQUE DIN 916 METRIC / CLASS 45H



NOTRE CODE	DESCRIPTION	QTÉ/BTE	NOTRE CODE	DESCRIPTION	QTÉ/BTE
OUR CODE	DESCRIPTION	QTY/BOX	OUR CODE	DESCRIPTION	QTY/BOX
*****	M1.6 X .35 X 2.5	100	ST004006	M4 X .70 X 6	100
*****	M1.6 X .35 X 3	100	*****	M4 X .70 X 8	100
*****	M1.6 X .35 X 4	100	ST040010	M4 X .70 X 10	100
*****	M1.6 X .35 X 5	100	ST040012	M4 X .70 X 12	100
*****	M2 X .40 X 2.5	100	ST004016	M4 X .70 X 16	100
*****	M2 X .40 X 3	100	ST040020	M4 X .70 X 20	100
*****	M2 X .40 X 4	100	ST004025	M4 X .70 X 25	100
*****	M2 X .40 X 5	100	ST005005	M5 X .80 X 5	100
ST002006	M2 X .40 X 6	100	ST005006	M5 X .80 X 6	100
*****	M2 X .40 X 8	100	ST005008	M5 X .80 X 8	100
ST002010	M2 X .40 X 10	100	ST005010	M5 X .80 X 10	100
*****	M2.5 X .45 X 3	100	ST005012	M5 X .80 X 12	100
*****	M2.5 X .45 X 4	100	ST005016	M5 X .80 X 16	100
ST002505	M2.5 X .45 X 5	100	ST005020	M5 X .80 X 20	100
ST002506	M2.5 X .45 X 6	100	ST005025	M5 X .80 X 25	100
*****	M2.5 X .45 X 8	100	ST005030	M5 X .80 X 30	100
*****	M2.5 X .45 X 10	100	ST005035	M5 X .80 X 35	100
ST003003	M3 X .50 X 3	100	*****	M5 X .80 X 40	100
ST003004	M3 X .50 X 4	100	ST005045	M5 X .80 X 45	100
ST003005	M3 X .50 X 5	100	*****	M5 X .80 X 50	100
*****	M3 X .50 X 6	100	ST006006	M6 X 1.00 X 6	100
SR003008	M3 X .50 X 8	100	ST006008	M6 X 1.00 X 8	100
ST003010	M3 X .50 X 10	100	ST006010	M6 X 1.00 X 10	100
ST003012	M3 X .50 X 12	100	ST006012	M6 X 1.00 X 12	100
*****	M3 X .50 X 16	100	ST006016	M6 X 1.00 X 16	100
ST003020	M3 X .50 X 20	100	ST006020	M6 X 1.00 X 20	100
ST003025	M3 X .50 X 25	100	ST006025	M6 X 1.00 X 25	100
ST004004	M4 X .70 X 4	100	*****	M6 X 1.00 X 30	100
ST004005	M4 X .70 X 5	100	ST006035	M6 X 1.00 X 35	100



MÉTRIQUE DIN 913 / METRIC DIN 913



NOTRE CODE	DESCRIPTION	QTÉ/BTE	NOTRE CODE	DESCRIPTION	QTÉ/BTE
OUR CODE	DESCRIPTION	QTY/BOX	OUR CODE	DESCRIPTION	QTY/BOX
ST006040	M6 X 1.00 X 40	100	ST012016	M12 X 1.75 X 16	100
ST006045	M6 X 1.00 X 45	100	ST012020	M12 X 1.75 X 20	100
ST006050	M6 X 1.00 X 50	100	ST012025	M12 X 1.75 X 25	100
ST008008	M8 X 1.25 X 8	100	ST012030	M12 X 1.75 X 30	100
ST008010	M8 X 1.25 X 10	100	ST012035	M12 X 1.75 X 35	100
ST008012	M8 X 1.25 X 12	100	ST012040	M12 X 1.75 X 40	50
ST008016	M8 X 1.25 X 16	100	ST012045	M12 X 1.75 X 45	50
ST008018	M8 X 1.25 X 18	100	ST012050	M12 X 1.75 X 50	50
ST008020	M8 X 1.25 X 20	100	*****	M12 X 1.75 X 55	50
ST008025	M8 X 1.25 X 25	100	ST012060	M12 X 1.75 X 60	50
ST008030	M8 X 1.25 X 30	100	*****	M12 X 1.75 X 70	50
ST008035	M8 X 1.25 X 35	100	*****	M12 X 1.75 X 80	50
ST008040	M8 X 1.25 X 40	100	ST012100	M12 X 1.75 X 100	50
ST008045	M8 X 1.25 X 45	100	ST016016	M16 X 2.00 X 16	50
ST008050	M8 X 1.25 X 50	100	*****	M16 X 2.00 X 20	50
ST010008	M10 X 1.50 X 8	100	*****	M16 X 2.00 X 25	50
ST010010	M10 X 1.50 X 10	100	*****	M16 X 2.00 X 30	50
*****	M10 X 1.50 X 12	100	*****	M16 X 2.00 X 35	50
ST010016	M10 X 1.50 X 16	100	ST016040	M16 X 2.00 X 40	50
ST010020	M10 X 1.50 X 20	100	*****	M16 X 2.00 X 45	50
ST010025	M10 X 1.50 X 25	100	ST016050	M16 X 2.00 X 50	50
ST010030	M10 X 1.50 X 30	100	*****	M16 X 2.00 X 55	50
ST010035	M10 X 1.50 X 35	100	*****	M16 X 2.00 X 60	50
ST010040	M10 X 1.50 X 40	100	ST020020	M20 X 2.50 X 20	50
*****	M10 X 1.50 X 45	50	*****	M20 X 2.50 X 25	50
*****	M10 X 1.50 X 50	50	*****	M20 X 2.50 X 30	50
*****	M10 X 1.50 X 55	50	*****	M20 X 2.50 X 35	50
ST010060	M10 X 1.50 X 60	50	*****	M20 X 2.50 X 40	50
ST012012	M12 X 1.75 X 12	100	*****	M20 X 2.50 X 45	50



MÉTRIQUE DIN 913 / METRIC DIN 913



NOTRE CODE	DESCRIPTION	QTÉ/BTE	NOTRE CODE	DESCRIPTION	QTÉ/BTE
OUR CODE	DESCRIPTION	QTY/BOX	OUR CODE	DESCRIPTION	QTY/BOX
*****	M20 X 2.50 X 50	25	*****	M24 X 3.00 X 40	25
*****	M20 X 2.50 X 55	25	*****	M24 X 3.00 X 45	25
*****	M20 X 2.50 X 60	25	*****	M24 X 3.00 X 50	25
*****	M20 X 2.50 X 70	25	*****	M24 X 3.00 X 55	25
*****	M20X 2.50 X 80	25	*****	M24 X 3.00 X 60	25
ST024025	M24 X 3.00 X 25	25	*****	M24 X 3.00 X 70	25
*****	M24 X 3.00 X 30	25	*****	M24 X 3.00 X 80	25
*****	M24 X 3.00 X 35	25			

AUSSI DISPONIBLE /

ALSO AVAILABLE

SS304 (A2) & SS316 (A4)



Tel.: (819) 346-2903 / (888) 345-2903 Fax.: (819) 346-3389

Email: distributeur@boulonsestrie.com

VIS À TÊTE RONDE
À 6 PANS CREUX
GROS FILETS

NOIR / BARE

BUTTON HEAD SOCKET
CAP SCREWS
NATIONAL COARSE

LA FINITION PLAQUÉE ZINC
EST DISPONIBLE
SUR DEMANDE

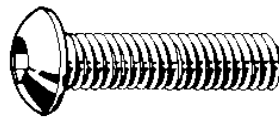

ZINC PLATED IS
AVAILABLE ON REQUEST

NOTRE CODE	DESCRIPTION	QTÉ/BTE	NOTRE CODE	DESCRIPTION	QTÉ/BTE
OUR CODE	DESCRIPTION	QTY/BOX	OUR CODE	DESCRIPTION	QTY/BOX
***** SB102001	2-56 X 1/8	SEMI-STD 100	SB105003	5-40 X 1/4	SEMI-STD
SB102002	2-56 X 3/16	100	SB105004	5-40 X 3/8	SEMI-STD
***** SB102004	2-56 X 1/4	100	SB105005	5-40 X 1/2	SEMI-STD
*****	2-56 X 5/16	SEMI-STD	*****	5-40 X 5/8	SEMI-STD
*****	2-56 X 3/8	100	SB105007	5-40 X 3/4	SEMI-STD
*****	2-56 X 1/2	100	*****	5-40 X 1	SEMI-STD
*****	2-56 X 5/8	SEMI-STD	*****	5-40 X 1 1/4	SEMI-STD
*****	2-56 X 3/4	SEMI-STD	*****	5-40 X 1 1/2	SEMI-STD
*****	2-56 X 1	SEMI-STD	*****	6-32 X 3/16	SEMI-STD
*****	3-48 X 3/16	100	SB106002	6-32 X 1/4	100
*****	3-48 X 1/4	100	*****	6-32 X 5/16	SEMI-STD
*****	3-48 X 5/16	SEMI-STD	SB106004	6-32 X 3/8	100
*****	3-48 X 3/8	100	*****	6-32 X 7/16	SEMI-STD
*****	3-48 X 1/2	100	SB106005	6-32 X 1/2	100
*****	3-48 X 5/8	SEMI-STD	SB106006	6-32 X 5/8	100
*****	3-48 X 3/4	SEMI-STD	SB106007	6-32 X 3/4	SEMI-STD
*****	3-48 X 7/8	SEMI-STD	*****	6-32 X 7/8	SEMI-STD
*****	3-48 X 1	SEMI-STD	SB106010	6-32 X 1	SEMI-STD
*****	4-40 X 3/16	SEMI-STD	*****	6-32 X 1 1/4	SEMI-STD
SB104002	4-40 X 1/4	100	SB106015	6-32 X 1 1/2	SEMI-STD
SB104003	4-40 X 5/16	SEMI-STD	*****	6-32 X 2	SEMI-STD
SB104004	4-40 X 3/8	100	*****	6-32 X 2 1/2	SEMI-STD
*****	4-40 X 7/16	SEMI-STD	*****	6-32 X 3	SEMI-STD
SB104005	4-40 X 1/2	100	*****	8-32 X 3/16	SEMI-STD
*****	4-40 X 5/8	SEMI-STD	SB108002	8-32 X 1/4	100
*****	4-40 X 3/4	SEMI-STD	*****	8-32 X 5/16	SEMI-STD
*****	4-40 X 7/8	SEMI-STD	SB108004	8-32 X 3/8	100
SB104010	4-40 X 1	SEMI-STD	*****	8-32 X 7/16	SEMI-STD

SEMI-STD PLUSIEURS QUANTITÉS DISPONIBLES / SEMI-STD PACKAGING ANY QUANTITY



Tel.: (819) 346-2903 / (888) 345-2903 Fax.: (819) 346-3389

Email: distributeur@boulonstrie.com

B-59

VIS À TÊTE RONDE
À 6 PANS CREUX
GROS FILETS

NOIR / BARE

BUTTON HEAD SOCKET
CAP SCREWS
NATIONAL COARSE

LA FINITION PLAQUÉE ZINC
EST DISPONIBLE
SUR DEMANDE

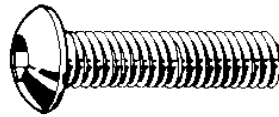

ZINC PLATED IS
AVAILABLE ON REQUEST

NOTRE CODE	DESCRIPTION	QTÉ/BTE	NOTRE CODE	DESCRIPTION	QTÉ/BTE
OUR CODE	DESCRIPTION	QTY/BOX	OUR CODE	DESCRIPTION	QTY/BOX
SB108005	8-32 X 1/2	100	SB125006	1/4-20 X 5/8	100
SB108006	8-32 X 5/8	100	SB125007	1/4-20 X 3/4	100
SB108007	8-32 X 3/4	100	SB125008	1/4-20 X 7/8	100
*****	8-32 X 7/8	SEMI-STD	SB125010	1/4-20 X 1	100
SB108010	8-32 X 1	SEMI-STD	SB125012	1/4-20 X 1 1/4	SEMI-STD
*****	8-32 X 1 1/4	SEMI-STD	SB125015	1/4-20 X 1 1/2	SEMI-STD
SB108015	8-32 X 1 1/2	SEMI-STD	SB125017	1/4-20 X 1 3/4	SEMI-STD
*****	8-32 X 1 3/4	SEMI-STD	SB125020	1/4-20 X 2	SEMI-STD
*****	8-32 X 2	SEMI-STD	SB125025	1/4-20 X 2 1/2	SEMI-STD
SB110002	10-24 X 1/4	100	*****	1/4-20 X 3	SEMI-STD
*****	10-24 X 5/16	SEMI-STD	*****	1/4-20 X 3 1/4	SEMI-STD
SB110004	10-24 X 3/8	100	*****	1/4-20 X 3 1/2	SEMI-STD
*****	10-24 X 7/16	SEMI-STD	SB131004	5/16-18 X 3/8	100
SB110005	10-24 X 1/2	100	SB131005	5/16-18 X 1/2	100
SB110006	10-24 X 5/8	100	SB131006	5/16-18 X 5/8	100
SB110007	10-24 X 3/4	100	SB131007	5/16-18 X 3/4	100
*****	10-24 X 7/8	100	SB131008	5/16-18 X 7/8	100
SB110010	10-24 X 1	100	SB131010	5/16-18 X 1	100
SB110012	10-24 X 1 1/4	SEMI-STD	SB131012	5/16-18 X 1 1/4	SEMI-STD
SB110015	10-24 X 1 1/2	SEMI-STD	SB131015	5/16-18 X 1 1/2	SEMI-STD
SB110017	10-24 X 1 3/4	SEMI-STD	SB131017	5/16-18 X 1 3/4	SEMI-STD
SB110020	10-24 X 2	SEMI-STD	SB131020	5/16-18 X 2	SEMI-STD
*****	10-24 X 2 1/4	SEMI-STD	*****	5/16-18 X 2 1/4	SEMI-STD
*****	10-24 X 2 1/2	SEMI-STD	SB131025	5/16-18 X 2 1/2	SEMI-STD
SB125002	1/4-20 X 1/4	SEMI-STD	SB131030	5/16-18 X 3	SEMI-STD
*****	1/4-20 X 5/16	SEMI-STD	*****	5/16-18 X 3 1/2	SEMI-STD
SB125004	1/4-20 X 3/8	100	*****	5/16-18 X 4	SEMI-STD
SB125005	1/4-20 X 1/2	100	SB137005	3/8-16 X 1/2	100

SEMI-STD PLUSIEURS QUANTITÉS DISPONIBLES / SEMI-STD PACKAGING ANY QUANTITY



Tel.: (819) 346-2903 / (888) 345-2903 Fax.: (819) 346-3389

Email: distributeur@boulonsestrie.com

B-60

VIS À TÊTE RONDE
 À 6 PANS CREUX
 GROS FILETS

NOIR / BARE

BUTTON HEAD SOCKET
 CAP SCREWS
 NATIONAL COARSE

LA FINITION PLAQUÉE ZINC
 EST DISPONIBLE
 SUR DEMANDE

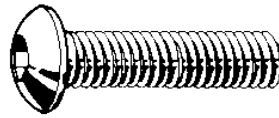

ZINC PLATED IS
 AVAILABLE ON REQUEST

NOTRE CODE	DESCRIPTION	QTÉ/BTE	NOTRE CODE	DESCRIPTION	QTÉ/BTE
OUR CODE	DESCRIPTION	QTY/BOX	OUR CODE	DESCRIPTION	QTY/BOX
*****	3/8-16 X 5/8	100	SB150012	1/2-13 X 1 1/4	100
SB137007	3/8-16 X 3/4	100	SB150015	1/2-13 X 1 1/2	100
SB137008	3/8-16 X 7/8	100	*****	1/2-13 X 1 3/4	SEMI-STD
SB137010	3/8-16 X 1	100	SB150020	1/2-13 X 2	100
SB137012	3/8-16 X 1 1/4	100	*****	1/2-13 X 2 1/4	SEMI-STD
SB137015	3/8-16 X 1 1/2	SEMI-STD	*****	1/2-13 X 2 1/2	SEMI-STD
SB137017	3/8-16 X 1 3/4	SEMI-STD	*****	1/2-13 X 3	SEMI-STD
SB137020	3/8-16 X 2	SEMI-STD	*****	1/2-13 X 3 1/2	SEMI-STD
SB137022	3/8-16 X 2 1/4	SEMI-STD	*****	1/2-13 X 4	SEMI-STD
SB137025	3/8-16 X 2 1/2	SEMI-STD	*****	5/8-11 X 1	50
SB137027	3/8-16 X 2 3/4	SEMI-STD	*****	5/8-11 X 1 1/4	50
SB137030	3/8-16 X 3	SEMI-STD	*****	5/8-11 X 1 1/2	50
*****	3/8-16 X 3 1/2	SEMI-STD	*****	5/8-11 X 1 3/4	SEMI-STD
*****	3/8-16 X 4	SEMI-STD	SB162020	5/8-11 X 2	50
*****	3/8-16 X 4 1/2	SEMI-STD	*****	5/8-11 X 2 1/4	SEMI-STD
SB150007	1/2-13 X 3/4	SEMI-STD	*****	5/8-11 X 2 1/2	SEMI-STD
*****	1/2-13 X 7/8	SEMI-STD	*****	5/8-11 X 3	SEMI-STD
SB150010	1/2-13 X 1	100			

SEMI-STD PLUSIEURS QUANTITÉS DISPONIBLES / SEMI-STD PACKAGING ANY QUANTITY



Tel.: (819) 346-2903 / (888) 345-2903 Fax.: (819) 346-3389

Email: distributeur@boulonsestrie.com

B-61

VIS À TÊTE RONDE
À 6 PANS CREUX
FILETS FINS

NOIR / BARE

BUTTON HEAD SOCKET
CAP SCREWS
NATIONAL FINE

LA FINITION PLAQUÉE ZINC
EST DISPONIBLE
SUR DEMANDE

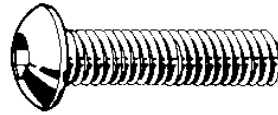

ZINC PLATED IS
AVAILABLE ON REQUEST

NOTRE CODE	DESCRIPTION	QTÉ/BTE	NOTRE CODE	DESCRIPTION	QTÉ/BTE
OUR CODE	DESCRIPTION	QTY/BOX	OUR CODE	DESCRIPTION	QTY/BOX
*****	0-80 X 1/8	100	SB111004	10-32 X 3/8	100
*****	0-80 X 3/16	100	*****	10-32 X 7/16	SEMI-STD
*****	0-80 X 1/4	100	SB111005	10-32 X 1/2	100
*****	0-80 X 3/8	100	SB111006	10-32 X 5/8	100
*****	0-80 X 1/2	SEMI-STD	SB111007	10-32 X 3/4	100
*****	0-80 X 5/8	SEMI-STD	*****	10-32 X 7/8	100
*****	0-80 X 3/4	SEMI-STD	SB111010	10-32 X 1	100
*****	0-80 X 1	SEMI-STD	SB111012	10-32 X 1 1/4	SEMI-STD
*****	1-72 X 1/8	100	SB111015	10-32 X 1 1/2	SEMI-STD
*****	1-72 X 3/16	100	SB111017	10-32 X 1 3/4	SEMI-STD
*****	1-72 X 1/4	100	SB110020	10-32 X 2	SEMI-STD
*****	1-72 X 5/16	SEMI-STD	*****	10-32 X 2 1/4	SEMI-STD
*****	1-72 X 3/8	100	*****	10-32 X 2 1/2	SEMI-STD
*****	1-72 X 1/2	SEMI-STD	*****	10-32 X 3	SEMI-STD
*****	1-72 X 5/8	SEMI-STD	SB126004	1/4-28 X 3/8	100
*****	1-72 X 3/4	SEMI-STD	SB126005	1/4-28 X 1/2	100
*****	1-72 X 1	SEMI-STD	*****	1/4-28 X 5/8	100
*****	6-40 X 1/4	SEMI-STD	SB126007	1/4-28 X 3/4	100
*****	6-40 X 3/8	SEMI-STD	*****	1/4-28 X 7/8	SEMI-STD
*****	6-40 X 1/2	SEMI-STD	SB126010	1/4-28 X 1	100
*****	8-36 X 1/4	SEMI-STD	SB126012	1/4-28 X 1 1/4	SEMI-STD
*****	8-36 X 3/8	SEMI-STD	SB126015	1/4-28 X 1 1/2	SEMI-STD
*****	8-36 X 1/2	SEMI-STD	SB126017	1/4-28 X 1 3/4	SEMI-STD
*****	8-36 X 5/8	SEMI-STD	SB126020	1/4-28 X 2	SEMI-STD
*****	8-36 X 3/4	SEMI-STD	*****	5/16-24 X 3/8	100
*****	8-36 X 1	SEMI-STD	*****	5/16-24 X 1/2	100
SB111002	10-32 X 1/4	100	*****	5/16-24 X 5/8	100
SB111003	10-32 X 5/16	SEMI-STD	*****	5/16-24 X 3/4	100

SEMI-STD PLUSIEURS QUANTITÉS DISPONIBLES / SEMI-STD PACKAGING ANY QUANTITY



Tel.: (819) 346-2903 / (888) 345-2903 Fax.: (819) 346-3389

Email: distributeur@boulonstrie.com

B-62

VIS À TÊTE RONDE
 À 6 PANS CREUX
 FILETS FINS

NOIR / BARE

BUTTON HEAD SOCKET
 CAP SCREWS
 NATIONAL FINE

LA FINITION PLAQUÉE ZINC
 EST DISPONIBLE
 SUR DEMANDE

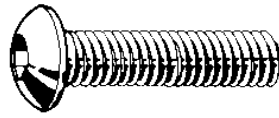

ZINC PLATED IS
 AVAILABLE ON REQUEST

NOTRE CODE	DESCRIPTION	QTÉ/BTE	NOTRE CODE	DESCRIPTION	QTÉ/BTE
OUR CODE	DESCRIPTION	QTY/BOX	OUR CODE	DESCRIPTION	QTY/BOX
*****	5/16-24 X 7/8	SEMI-STD	*****	3/8-24 X 1 3/4	SEMI-STD
*****	5/16-24 X 1	100	*****	3/8-24 X 2	SEMI-STD
*****	5/16-24 X 1 1/4	SEMI-STD	*****	3/8-24 X 2 1/4	SEMI-STD
*****	5/16-24 X 1 1/2	SEMI-STD	*****	3/8-24 X 2 1/2	SEMI-STD
*****	5/16-24 X 1 3/4	SEMI-STD	*****	3/8-24 X 3	SEMI-STD
*****	5/16-24 X 2	SEMI-STD	*****	1/2-20 X 1	SEMI-STD
*****	3/8-24 X 1/2	100	*****	1/2-20 X 1 1/4	SEMI-STD
*****	3/8-24 X 5/8	100	*****	1/2-20 X 1 1/2	SEMI-STD
SB138007	3/8-24 X 3/4	100	*****	1/2-20 X 2	SEMI-STD
*****	3/8-24 X 7/8	SEMI-STD	*****	1/2-20 X 2 1/2	SEMI-STD
*****	3/8-24 X 1	SEMI-STD	*****	1/2-20 X 3	SEMI-STD
SB138012	3/8-24 X 1 1/4	SEMI-STD	*****	1/2-20 X 4	SEMI-STD
*****	3/8-24 X 1 1/2	SEMI-STD			

SEMI-STD PLUSIEURS QUANTITÉS DISPONIBLES / SEMI-STD PACKAGING ANY QUANTITY



Tel.: (819) 346-2903 / (888) 345-2903 Fax.: (819) 346-3389

Email: distributeur@boulonsestrie.com

B-63

VIS À TÊTE RONDE
 À 6 PANS CREUX
 GROS FILETS

SS-304
 18-8

BUTTON HEAD SOCKET
 CAP SCREWS
 NATIONAL COARSE

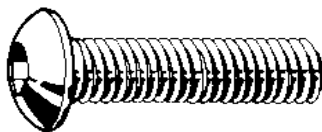

NOTRE CODE	DESCRIPTION	QTÉ/BTE
OUR CODE	DESCRIPTION	QTY/BOX
SB206001	6-32 X 3/16	100
SB206002	6-32 X 1/4	100
SB206004	6-32 X 3/8	100
SB206005	6-32 X 1/2	100
SB206006	6-32 X 5/8	100
SB206007	6-32 X 3/4	100
SB208004	8-32 X 3/8	100
SB208005	8-32 X 1/2	100
SB208006	8-32 X 5/8	100
SB208007	8-32 X 3/4	100
SB208020	8-32 X 2	100
SB210002	10-24 X 1/4	100
SB210004	10-24 X 3/8	100
SB210005	10-24 X 1/2	100
SB210007	10-24 X 3/4	100
SB210015	10-24 X 1 1/2	100
SB211002	10-32 X 1/4	100
SB211004	10-32 X 3/8	100
SB211005	10-32 X 1/2	100
SB211006	10-32 X 5/8	100
SB211007	10-32 X 3/4	100
SB211010	10-32 X 1	100
SB225003	1/4-20 X 3/8	100
SB225005	1/4-20 X 1/2	100
SB225006	1/4-20 X 5/8	100
SB225007	1/4-20 X 3/4	100
SB225008	1/4-20 X 7/8	100
SB225010	1/4-20 X 1	100

AUTRES DIMENSIONS DISPONIBLES / OTHER DIMENSION ARE AVAILABLE



Tel.: (819) 346-2903 / (888) 345-2903 Fax.: (819) 346-3389
 Email: distributeur@boulonstrie.com

VIS À TÊTE RONDE
À 6 PANS CREUX
GROS FILETS

SS-304
18-8

BUTTON HEAD SOCKET
CAP SCREWS
NATIONAL COARSE

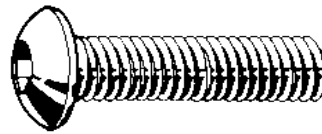

NOTRE CODE	DESCRIPTION	QTÉ/BTE
OUR CODE	DESCRIPTION	QTY/BOX
SB225012	1/4-20 X 1 1/4	100
SB225015	1/4-20 X 1 1/2	100
SB225017	1/4-20 X 1 3/4	100
SB225022	1/4-20 X 2 1/4	100
SB231004	5/16-18 X 3/8	100
SB231005	5/16-18 X 1/2	100
SB231006	5/16-18 X 5/8	100
SB231007	5/16-18 X 3/4	100
SB231010	5/16-18 X 1	100
SB231015	5/16-18 X 1 1/2	100
SB237006	3/8-16 X 5/8	100
SB237007	3/8-16 X 3/4	100
SB237010	3/8-16 X 1	100
SB237012	3/8-16 X 1 1/4	100
SB237020	3/8-16 X 2	100

AUTRES DIMENSIONS DISPONIBLES / OTHER DIMENSION ARE AVAILABLE



Tel.: (819) 346-2903 / (888) 345-2903 Fax.: (819) 346-3389
Email: distributeur@boulonsestrie.com

B-65

VIS À TÊTE RONDE
À 6 PANS CREUX
GROS FILETS

NOIR / BARE
GRADE 12.9

BUTTON HEAD SOCKET
CAP SCREWS
NATIONAL COARSE

MÉTRIQUE DIN 7380 METRIC

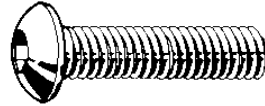

NOTRE CODE	DESCRIPTION	QTÉ/BTE	NOTRE CODE	DESCRIPTION	QTÉ/BTE
OUR CODE	DESCRIPTION	QTY/BOX	OUR CODE	DESCRIPTION	QTY/BOX
SBM03006	M3 X .50 X 6	100	SBM06025	M6 X 1.00 X 25	100
SBM03008	M3 X .50 X 8	100	SBM06030	M6 X 1.00 X 30	100
SBM03010	M3 X .50 X 10	100	SBM06035	M6 X 1.00 X 35	100
SBM03012	M3 X .50 X 12	100	SBM06040	M6 X 1.00 X 40	100
SBM03016	M3 X .50 X 16	100	SBM08010	M8 X 1.25 X 10	50
SBM03020	M3 X .50 X 20	100	SBM08012	M8 X 1.25 X 12	50
SBM03025	M3 X .50 X 25	100	*****	M8 X 1.25 X 14	50
SBM04006	M4 X .70 X 6	100	SBM08016	M8 X 1.25 X 16	50
SBM04008	M4 X .70 X 8	100	SBM08020	M8 X 1.25 X 20	50
SBM04010	M4 X .70 X 10	100	SBM08025	M8 X 1.25 X 25	50
SBM04012	M4 X .70 X 12	100	SBM08030	M8 X 1.25 X 30	50
SBM04020	M4 X .70 X 20	100	SBM08035	M8 X 1.25 X 35	50
SBM04025	M4 X .70 X 25	100	SBM08040	M8 X 1.25 X 40	50
SBM04030	M4 X .70 X 30	100	SBM08050	M8 X 1.25 X 50	50
SBM05006	M5 X .80 X 6	100	SBM10012	M10 X 1.50 X 12	25
SBM05008	M5 X .80 X 8	100	*****	M10 X 1.50 X 16	25
SBM05010	M5 X .80 X 10	100	SBM10020	M10 X 1.50 X 20	25
SBM05012	M5 X .80 X 12	100	SBM10025	M10 X 1.50 X 25	25
SBM05016	M5 X .80 X 16	100	*****	M10 X 1.50 X 30	25
SBM05020	M5 X .80 X 20	100	SBM10035	M10 X 1.50 X 35	25
SBM05025	M5 X .80 X 25	100	*****	M10 X 1.50 X 40	25
SBM05030	M5 X .80 X 30	100	*****	M12 X 1.75 X 16	25
SBM05035	M5 X .80 X 35	100	*****	M12 X 1.75 X 20	25
SBM05050	M5 X .80 X 50	100	SBM12025	M12 X 1.75 X 25	25
SBM06006	M6 X 1.00 X 6	100	*****	M12 X 1.75 X 30	25
SBM06010	M6 X 1.00 X 10	100	*****	M12 X 1.75 X 35	25
SBM06012	M6 X 1.00 X 12	100	SBM12040	M12 X 1.75 X 40	25
SBM06016	M6 X 1.00 X 16	100	*****	M12 X 1.75 X 45	25
SBM06020	M6 X 1.00 X 20	100	*****	M12 X 1.75 X 50	25

AUTRES DIMENSION DISPONIBLE / OTHER DIMENSION ARE AVAILABLE



Tel.: (819) 346-2903 / (888) 345-2903 Fax.: (819) 346-3389

Email: distributeur@boulonsestrie.com

B-66

VIS A ÉPAULEMENT À
TÊTE CREUSE 6 PANS

NOIR / BARE
ALLOY STEEL

SOCKET SHOULDER
SCREWS

LA FINITION PLAQUÉE ZINC
EST DISPONIBLE
SUR DEMANDE



ZINC PLATED IS
AVAILABLE ON REQUEST

NOTRE CODE	DESCRIPTION	FILET	QTÉ/BTE
OUR CODE	DESCRIPTION	THREAD	QTY/BOX
SO025002	1/4 X 1/4	10-24	SEMI-STD
*****	1/4 X 5/16	10-24	SEMI-STD
SO025004	1/4 X 3/8	10-24	25
*****	1/4 X 7/16	10-24	SEMI-STD
SO025005	1/4 X 1/2	10-24	25
SO025006	1/4 X 5/8	10-24	25
S0025007	1/4 X 3/4	10-24	25
*****	1/4 X 7/8	10-24	SEMI-STD
SO025010	1/4 X 1	10-24	25
SO025012	1/4 X 1 1/4	10-24	25
S0025015	1/4 X 1 1/2	10-24	25
SO025017	1/4 X 1 3/4	10-24	SEMI-STD
SO025020	1/4 X 2	10-24	SEMI-STD
SO025022	1/4 X 2 1/4	10-24	SEMI-STD
SO025025	1/4 X 2 1/2	10-24	SEMI-STD
*****	1/4 X 2 3/4	10-24	SEMI-STD
SO025030	1/4 X 3	10-24	SEMI-STD
*****	1/4 X 3 1/4	10-24	SEMI-STD
*****	1/4 X 3 1/2	10-24	SEMI-STD
*****	1/4 X 4	10-24	SEMI-STD
SO031002	5/16 X 1/4	1/4-20	SEMI-STD
*****	5/16 X 5/16	1/4-20	SEMI-STD
S0031004	5/16 X 3/8	1/4-20	25
SO031005	5/16 X 1/2	1/4-20	25
SO031006	5/16 X 5/8	1/4-20	25
SO031007	5/16 X 3/4	1/4-20	25
SO031008	5/16 X 7/8	1/4-20	SEMI-STD
SO031010	5/16 X 1	1/4-20	25
SO031012	5/16 X 1 1/4	1/4-20	25



Tel.: (819) 346-2903 / (888) 345-2903 Fax.: (819) 346-3389

Email: distributeur@boulonstrie.com

B-67

VIS A ÉPAULEMENT À
TÊTE CREUSE 6 PANS

NOIR / BARE
ALLOY STEEL

SOCKET SHOULDER
SCREWS

LA FINITION PLAQUÉE ZINC
EST DISPONIBLE
SUR DEMANDE



ZINC PLATED IS
AVAILABLE ON REQUEST

NOTRE CODE	DESCRIPTION	FILET	QTÉ/BTE
OUR CODE	DESCRIPTION	THREAD	QTY/BOX
SO031015	5/16 X 1 1/2	1/4-20	25
SO031017	5/16 X 1 3/4	1/4-20	25
SO031020	5/16 X 2	1/4-20	25
SO031022	5/16 X 2 1/4	1/4-20	SEMI-STD
SO031025	5/16 X 2 1/2	1/4-20	SEMI-STD
SO031027	5/16 X 2 3/4	1/4-20	SEMI-STD
SO031030	5/16 X 3	1/4-20	SEMI-STD
*****	5/16 X 3 1/4	1/4-20	SEMI-STD
*****	5/16 X 3 1/2	1/4-20	SEMI-STD
*****	5/16 X 3 3/4	1/4-20	SEMI-STD
*****	5/16 X 4	1/4-20	SEMI-STD
SO037002	3/8 X 1/4	5/16-18	SEMI-STD
*****	3/8 X 5/16	5/16-18	SEMI-STD
SO037004	3/8 X 3/8	5/16-18	25
SO037005	3/8 X 1/2	5/16-18	25
SO037006	3/8 X 5/8	5/16-18	25
SO037007	3/8 X 3/4	5/16-18	25
SO037008	3/8 X 7/8	5/16-18	SEMI-STD
SO037010	3/8 X 1	5/16-18	25
SO037012	3/8 X 1 1/4	5/16-18	25
SO037015	3/8 X 1 1/2	5/16-18	25
SO037017	3/8 X 1 3/4	5/16-18	25
SO037020	3/8 X 2	5/16-18	25
SO037022	3/8 X 2 1/4	5/16-18	25
SO037025	3/8 X 2 1/2	5/16-18	25
SO037027	3/8 X 2 3/4	5/16-18	25
SO037030	3/8 X 3	5/16-18	25
SO037032	3/8 X 3 1/4	5/16-18	25
SO037035	3/8 X 3 1/2	5/16-18	25



Tel.: (819) 346-2903 / (888) 345-2903 Fax.: (819) 346-3389

Email: distributeur@boulonstrie.com

B-68

VIS A ÉPAULEMENT À
TÊTE CREUSE 6 PANS

NOIR / BARE
ALLOY STEEL

SOCKET SHOULDER
SCREWS

LA FINITION PLAQUÉE ZINC
EST DISPONIBLE
SUR DEMANDE



ZINC PLATED IS
AVAILABLE ON REQUEST

NOTRE CODE	DESCRIPTION	FILET	QTÉ/BTE
OUR CODE	DESCRIPTION	THREAD	QTY/BOX
SO037037	3/8 X 3 3/4	5/16-18	25
SO037040	3/8 X 4	5/16-18	25
SO037045	3/8 X 4 1/2	5/16-18	SEMI-STD
*****	3/8 X 5	5/16-18	SEMI-STD
*****	3/8 X 5 1/2	5/16-18	SEMI-STD
SO037060	3/8 X 6	5/16-18	SEMI-STD
SO050004	1/2 X 3/8	3/8-16	SEMI-STD
SO050005	1/2 X 1/2	3/8-16	25
SO050006	1/2 X 5/8	3/8-16	25
SO050007	1/2 X 3/4	3/8-16	25
SO050008	1/2 X 7/8	3/8-16	SEMI-STD
SO050010	1/2 X 1	3/8-16	25
SO050012	1/2 X 1 1/4	3/8-16	25
SO050015	1/2 X 1 1/2	3/8-16	25
*****	1/2 X 1 5/8	3/8-16	SEMI-STD
SO050017	1/2 X 1 3/4	3/8-16	25
SO050020	1/2 X 2	3/8-16	25
SO050022	1/2 X 2 1/4	3/8-16	SEMI-STD
SO050025	1/2 X 2 1/2	3/8-16	25
SO050027	1/2 X 2 3/4	3/8-16	25
SO050030	1/2 X 3	3/8-16	25
SO050032	1/2 X 3 1/4	3/8-16	25
SO050035	1/2 X 3 1/2	3/8-16	25
SO050037	1/2 X 3 3/4	3/8-16	25
SO050040	1/2 X 4	3/8-16	25
*****	1/2 X 4 1/4	3/8-16	25
SO050045	1/2 X 4 1/2	3/8-16	25
*****	1/2 X 4 3/4	3/8-16	25
SO050050	1/2 X 5	3/8-16	25



Tel.: (819) 346-2903 / (888) 345-2903 Fax.: (819) 346-3389

Email: distributeur@boulonstrie.com

B-69

VIS A ÉPAULEMENT À
TÊTE CREUSE 6 PANS

NOIR / BARE
ALLOY STEEL

SOCKET SHOULDER
SCREWS

LA FINITION PLAQUÉE ZINC
EST DISPONIBLE
SUR DEMANDE



ZINC PLATED IS
AVAILABLE ON REQUEST

NOTRE CODE	DESCRIPTION	FILET	QTÉ/BTE
OUR CODE	DESCRIPTION	THREAD	QTY/BOX
*****	1/2 X 5 1/2	3/8-16	SEMI-STD
SO050060	1/2 X 6	3/8-16	SEMI-STD
*****	1/2 X 6 1/2	3/8-16	SEMI-STD
SO050070	1/2 X 7	3/8-16	SEMI-STD
*****	1/2 X 8	3/8-16	SEMI-STD
SO062005	5/8 X 1/2	1/2-13	SEMI-STD
*****	5/8 X 5/8	1/2-13	SEMI-STD
SO062007	5/8 X 3/4	1/2-13	SEMI-STD
*****	5/8 X 7/8	1/2-13	SEMI-STD
SO062010	5/8 X 1	1/2-13	SEMI-STD
SO062012	5/8 X 1 1/4	1/2-13	25
SO062015	5/8 X 1 1/2	1/2-13	25
SO062017	5/8 X 1 3/4	1/2-13	25
SO062020	5/8 X 2	1/2-13	25
SO062022	5/8 X 2 1/4	1/2-13	25
SO062025	5/8 X 2 1/2	1/2-13	25
SO062027	5/8 X 2 3/4	1/2-13	25
SO062030	5/8 X 3	1/2-13	10
SO062032	5/8 X 3 1/4	1/2-13	10
SO062035	5/8 X 3 1/2	1/2-13	10
SO062037	5/8 X 3 3/4	1/2-13	10
SO062040	5/8 X 4	1/2-13	10
*****	5/8 X 4 1/4	1/2-13	10
SO062045	5/8 X 4 1/2	1/2-13	10
SO062047	5/8 X 4 3/4	1/2-13	10
*****	5/8 X 5	1/2-13	10
*****	5/8 X 5 1/2	1/2-13	10
SO062060	5/8 X 6	1/2-13	10
*****	5/8 X 6 1/2	1/2-13	SEMI-STD



Tel.: (819) 346-2903 / (888) 345-2903 Fax.: (819) 346-3389

Email: distributeur@boulonstrie.com

B-70

VIS A ÉPAULEMENT À
TÊTE CREUSE 6 PANS

NOIR / BARE
ALLOY STEEL

SOCKET SHOULDER
SCREWS

LA FINITION PLAQUÉE ZINC
EST DISPONIBLE
SUR DEMANDE

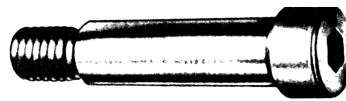

ZINC PLATED IS
AVAILABLE ON REQUEST

NOTRE CODE	DESCRIPTION	FILET	QTÉ/BTE
OUR CODE	DESCRIPTION	THREAD	QTY/BOX
*****	5/8 X 7	1/2-13	SEMI-STD
SO062080	5/8 X 8	1/2-13	SEMI-STD
*****	3/4 X 1/2	5/8-11	SEMI-STD
*****	3/4 X 5/8	5/8-11	SEMI-STD
SO075007	3/4 X 3/4	5/8-11	SEMI-STD
*****	3/4 X 7/8	5/8-11	SEMI-STD
SO075010	3/4 X 1	5/8-11	SEMI-STD
SO075012	3/4 X 1 1/4	5/8-11	SEMI-STD
SO075015	3/4 X 1 1/2	5/8-11	10
SO075017	3/4 X 1 3/4	5/8-11	10
SO075020	3/4 X 2	5/8-11	10
SO075022	3/4 X 2 1/4	5/8-11	10
SO075025	3/4 X 2 1/2	5/8-11	10
SO075027	3/4 X 2 3/4	5/8-11	10
SO075030	3/4 X 3	5/8-11	10
*****	3/4 X 3 1/4	5/8-11	10
SO075035	3/4 X 3 1/2	5/8-11	10
*****	3/4 X 3 3/4	5/8-11	10
SO075040	3/4 X 4	5/8-11	10
*****	3/4 X 4 1/4	5/8-11	10
SO075045	3/4 X 4 1/2	5/8-11	10
*****	3/4 X 4 3/4	5/8-11	10
SO075050	3/4 X 5	5/8-11	10
SO075055	3/4 X 5 1/2	5/8-11	10
SO075060	3/4 X 6	5/8-11	10
SO075065	3/4 X 6 1/2	5/8-11	SEMI-STD
SO075070	3/4 X 7	5/8-11	SEMI-STD
SO090010	1 X 1	3/4-10	SEMI-STD
SO090012	1 X 1 1/4	3/4-10	SEMI-STD



Tel.: (819) 346-2903 / (888) 345-2903 Fax.: (819) 346-3389

Email: distributeur@boulonstrie.com

B-71

VIS A ÉPAULEMENT À
TÊTE CREUSE 6 PANS

NOIR / BARE
ALLOY STEEL

SOCKET SHOULDER
SCREWS

LA FINITION PLAQUÉE ZINC
EST DISPONIBLE
SUR DEMANDE



ZINC PLATED IS
AVAILABLE ON REQUEST

NOTRE CODE	DESCRIPTION	FILET	QTÉ/BTE
OUR CODE	DESCRIPTION	THREAD	QTY/BOX
SO090015	1 X 1 1/2	3/4-10	SEMI-STD
SO090017	1 X 1 3/4	3/4-10	SEMI-STD
SO090020	1 X 2	3/4-10	SEMI-STD
*****	1 X 2 1/4	3/4-10	SEMI-STD
SO090025	1 X 2 1/2	3/4-10	SEMI-STD
SO090027	1 X 2 3/4	3/4-10	SEMI-STD
SO090030	1 X 3	3/4-10	SEMI-STD
*****	1 X 3 1/4	3/4-10	SEMI-STD
*****	1 X 3 1/2	3/4-10	SEMI-STD
*****	1 X 4	3/4-10	SEMI-STD
*****	1 X 4 1/2	3/4-10	SEMI-STD
*****	1 X 5	3/4-10	SEMI-STD
*****	1 X 6	3/4-10	SEMI-STD
*****	1 X 6 1/2	3/4-10	SEMI-STD
*****	1 X 7	3/4-10	SEMI-STD
*****	1 1/4 X 2 1/4	7/8-9	SEMI-STD
*****	1 1/4 X 2 1/2	7/8-9	SEMI-STD
*****	1 1/4 X 2 3/4	7/8-9	SEMI-STD
*****	1 1/4 X 3	7/8-9	SEMI-STD
*****	1 1/4 X 3 1/4	7/8-9	SEMI-STD
*****	1 1/4 X 3 1/2	7/8-9	SEMI-STD
*****	1 1/4 X 4	7/8-9	SEMI-STD
*****	1 1/4 X 4 1/2	7/8-9	SEMI-STD
*****	1 1/4 X 5	7/8-9	SEMI-STD
*****	1 1/4 X 6	7/8-9	SEMI-STD



Tel.: (819) 346-2903 / (888) 345-2903 Fax.: (819) 346-3389
Email: distributeur@boulonsestrie.com

B-72

**VIS À ÉPAULEMENT À
TÊTE CREUSE 6 PANS
GROS FILETS**

NOIR / BARE

**SOCKET SHOULDER SCREWS
NATIONAL COARSE**

MÉTRIQUE DIN 9841 METRIC

**LA FINITION PLAQUÉE ZINC
EST DISPONIBLE
SUR DEMANDE**



**ZINC PLATED IS
AVAILABLE ON REQUEST**

NOTRE CODE	DESCRIPTION	FILET	QTÉ/BTE
OUR CODE	DESCRIPTION	THREAD	QTY/BOX
SO106010	M6 X 1.00 X 10	M5 X .80	25
SO106012	M6 X 1.00 X 12	M5 X .80	25
SO106016	M6 X 1.00 X 16	M5 X .80	25
SO106020	M6 X 1.00 X 20	M5 X .80	25
*****	M6 X 1.00 X 25	M5 X .80	25
*****	M6 X 1.00 X 30	M5 X .80	25
*****	M6 X 1.00 X 40	M5 X .80	25
*****	M6 X 1.00 X 50	M5 X .80	25
SO108012	M8 X 1.25 X 12	M6 X 1.00	25
SO108016	M8 X 1.25 X 16	M6 X 1.00	25
*****	M8 X 1.25 X 20	M6 X 1.00	25
*****	M8 X 1.25 X 25	M6 X 1.00	25
*****	M8 X 1.25 X 30	M6 X 1.00	25
*****	M8 X 1.25 X 40	M6 X 1.00	25
*****	M8 X 1.25 X 50	M6 X 1.00	25
*****	M8 X 1.25 X 60	M6 X 1.00	25
*****	M8 X 1.25 X 70	M6 X 1.00	25
SO110016	M10 X 1.50 X 16	M8 X 1.25	25
SO110020	M10 X 1.50 X 20	M8 X 1.25	25
SO110025	M10 X 1.50 X 25	M8 X 1.25	25
*****	M10 X 1.50 X 30	M8 X 1.25	25
SO110040	M10 X 1.50 X 40	M8 X 1.25	25
*****	M10 X 1.50 X 50	M8 X 1.25	25
SO110060	M10 X 1.50 X 60	M8 X 1.25	25
*****	M10 X 1.50 X 70	M8 X 1.25	25
*****	M10 X 1.50 X 80	M8 X 1.25	25
SO112010	M12 X 1.75 X 10	M10 X 1.50	25
SO112012	M12 X 1.75 X 12	M10 X 1.50	25
SO112016	M12 X 1.75 X 16	M10 X 1.50	25



Tel.: (819) 346-2903 / (888) 345-2903 Fax.: (819) 346-3389

Email: distributeur@boulonsestrie.com

B-73

**VIS À ÉPAULEMENT À
TÊTE CREUSE 6 PANS
GROS FILETS**

NOIR / BARE

**SOCKET SHOULDER SCREWS
NATIONAL COARSE**

MÉTRIQUE DIN 9841 METRIC

**LA FINITION PLAQUÉE ZINC
EST DISPONIBLE
SUR DEMANDE**



**ZINC PLATED IS
AVAILABLE ON REQUEST**

NOTRE CODE	DESCRIPTION	FILET	QTÉ/BTE
OUR CODE	DESCRIPTION	THREAD	QTY/BOX
SO112020	M12 X 1.75 X 20	M10 X 1.50	25
*****	M12 X 1.75 X 25	M10 X 1.50	25
*****	M12 X 1.75 X 30	M10 X 1.50	25
SO112040	M12 X 1.75 X 40	M10 X 1.50	25
*****	M12 X 1.75 X 50	M10 X 1.50	25
SO112060	M12 X 1.75 X 60	M10 X 1.50	25
*****	M12 X 1.75 X 70	M10 X 1.50	25
*****	M12 X 1.75 X 80	M10 X 1.50	25
*****	M12 X 1.75 X 90	M10 X 1.50	25
*****	M12 X 1.75 X 100	M10 X 1.50	25
*****	M16 X 2.00 X 30	M12 X 1.75	25
*****	M16 X 2.00 X 40	M12 X 1.75	25
*****	M16 X 2.00 X 50	M12 X 1.75	25
*****	M16 X 2.00 X 60	M12 X 1.75	25
*****	M16 X 2.00 X 70	M12 X 1.75	25
*****	M16 X 2.00 X 80	M12 X 1.75	25
*****	M16 X 2.00 X 90	M12 X 1.75	25
*****	M16 X 2.00 X 100	M12 X 1.75	25
*****	M16 X 2.00 X 120	M12 X 1.75	25
*****	M20 X 2.50 X 40	M16 X 2.00	10
*****	M20 X 2.50 X 50	M16 X 2.00	10
*****	M20 X 2.50 X 60	M16 X 2.00	10
*****	M20 X 2.50 X 70	M16 X 2.00	10
*****	M20 X 2.50 X 80	M16 X 2.00	10
*****	M20 X 2.50 X 90	M16 X 2.00	10
*****	M20 X 2.50 X 100	M16 X 2.00	10
*****	M20 X 2.50 X 120	M16 X 2.00	10



Tel.: (819) 346-2903 / (888) 345-2903 Fax.: (819) 346-3389

Email: distributeur@boulonsestrie.com

B-74

VIS DE PRESSION
À TÊTE CARRÉE
GROS FILETS

NOIR / BARE

SQUARE HEAD
SET SCREWS
NATIONAL COARSE

LA FINITION PLAQUÉE ZINC
EST DISPONIBLE
SUR DEMANDE



ZINC PLATED IS
AVAILABLE ON REQUEST

NOTRECODE	DESCRIPTION	QTÉ/BTE	NOTRECODE	DESCRIPTION	QTÉ/BTE
OUR CODE	DESCRIPTION	QTY/BOX	OUR CODE	DESCRIPTION	QTY/BOX
SQ025003	1/4-20 X 3/8	100	*****	3/8-16 X 7/8	100
SQ025005	1/4-20 X 1/2	100	SQ037010	3/8-16 X 1	100
SQ025006	1/4-20 X 5/8	100	SQ037012	3/8-16 X 1 1/4	100
SQ025007	1/4-20 X 3/4	100	SQ037015	3/8-16 X 1 1/2	100
SQ025008	1/4-20 X 7/8	100	SQ037017	3/8-16 X 1 3/4	100
SQ025010	1/4-20 X 1	100	SQ037020	3/8-16 X 2	100
SQ025012	1/4-20 X 1 1/4	100	SQ037022	3/8-16 X 2 1/4	100
SQ025015	1/4-20 X 1 1/2	100	SQ037025	3/8-16 X 2 1/2	100
SQ025017	1/4-20 X 1 3/4	100	SQ037030	3/8-16 X 3	50
SQ025020	1/4-20 X 2	100	*****	3/8-16 X 3 1/2	50
*****	1/4-20 X 2 1/4	100	SQ037040	3/8-16 X 4	50
*****	1/4-20 X 2 1/2	100	*****	3/8-16 X 4 1/2	50
SQ025030	1/4-20 X 3	100	SQ037050	3/8-16 X 5	50
SQ025035	1/4-20 X 3 1/2	100	SQ043007	7/16-14 X 3/4	100
SQ031005	5/16-18 X 1/2	100	SQ043010	7/16-14 X 1	100
SQ031006	5/16-18 X 5/8	100	SQ043012	7/16-14 X 1 1/4	100
SQ031007	5/16-18 X 3/4	100	SQ043015	7/16-14 X 1 1/2	100
SQ031008	5/16-18 X 7/8	100	SQ043017	7/16-14 X 1 3/4	100
SQ031010	5/16-18 X 1	100	SQ043020	7/16-14 X 2	50
SQ031012	5/16-18 X 1 1/4	100	*****	7/16-14 X 2 1/4	50
SQ031015	5/16-18 X 1 1/2	100	SQ043025	7/16-14 X 2 1/2	50
SQ031017	5/16-18 X 1 3/4	100	*****	7/16-14 X 3	50
SQ031020	5/16-18 X 2	100	SQ050040	7/16-14 X 4	50
*****	5/16-18 X 2 1/4	100	SQ050006	1/2-13 X 5/8	50
SQ031025	5/16-18 X 2 1/2	100	SQ050007	1/2-13 X 3/4	50
SQ031030	5/16-18 X 3	100	*****	1/2-13 X 7/8	50
SQ037005	3/8-16 X 1/2	100	SQ050010	1/2-13 X 1	50
SQ037006	3/8-16 X 5/8	100	SQ050012	1/2-13 X 1 1/4	50
SQ037007	3/8-16 X 3/4	100	SQ050015	1/2-13 X 1 1/2	50



Tel.: (819) 346-2903 / (888) 345-2903 Fax.: (819) 346-3389

Email: distributeur@boulonstrie.com

B-75

VIS DE PRESSION
À TÊTE CARRÉE
GROS FILETS

NOIR / BARE

SQUARE HEAD
SET SCREWS
NATIONAL COARSE

LA FINITION PLAQUÉE ZINC
EST DISPONIBLE
SUR DEMANDE



ZINC PLATED AVAILABLE
ON REQUEST

NOTRECODE	DESCRIPTION	QTÉ/BTE	NOTRECODE	DESCRIPTION	QTÉ/BTE
OUR CODE	DESCRIPTION	QTY/BOX	OUR CODE	DESCRIPTION	QTY/BOX
SQ050017	1/2-13 X 1 3/4	50	SQ062025	5/8-11 X 2 1/2	25
SQ050020	1/2-13 X 2	50	*****	5/8-11 X 2 3/4	25
SQ050022	1/2-13 X 2 1/4	50	SQ062030	5/8-11 X 3	25
SQ050025	1/2-13 X 2 1/2	50	SQ062035	5/8-11 X 3 1/2	25
SQ050027	1/2-13 X 2 3/4	50	SQ062040	5/8-11 X 4	25
SQ050030	1/2-13 X 3	50	SQ062045	5/8-11 X4 1/2	25
SQ050035	1/2-13 X 3 1/2	25	SQ062050	5/8-11 X 5	25
SQ050040	1/2-13 X 4	25	*****	5/8-11 X 5 1/2	25
SQ050045	1/2-13 X 4 1/2	25	SQ062060	5/8-11 X 6	25
SQ050050	1/2-13 X 5	25	*****	3/4-10 X 1	25
SQ050060	1/2-13 X 6	25	SQ075012	3/4-10 X 1 1/4	25
*****	9/16-12 X 1	50	SQ075015	3/4-10 X 1 1/2	25
*****	9/16-12 X 1 1/4	50	SQ075017	3/4-10 X 1 3/4	25
*****	9/16-12 X 1 1/2	50	SQ075020	3/4-10 X 2	25
*****	9/16-12 X 1 3/4	50	*****	3/4-10 X 2 1/4	25
*****	9/16-12 X 2	50	SQ075025	3/4-10 X 2 1/2	25
*****	9/16-12 X 2 1/2	50	*****	3/4-10 X 2 3/4	25
SQ056030	9/16-12 X 3	50	SQ075030	3/4-10 X 3	25
*****	9/16-12 X 3 1/2	25	SQ075035	3/4-10 X 3 1/2	25
*****	9/16-12 X 4	25	SQ075040	3/4-10 X 4	25
SQ062006	5/8-11 X 5/8	50	SQ075045	3/4-10 X 4 1/2	25
SQ062007	5/8-11 X 3/4	50	SQ075050	3/4-10 X 5	25
*****	5/8-11 X 7/8	50	SQ075055	3/4-10 X 5 1/2	25
SQ062010	5/8-11 X 1	50	SQ075060	3/4-10 X 6	10
SQ062012	5/8-11 X 1 1/4	50	SQ075065	3/4-10 X 6 1/2	10
SQ062015	5/8-11 X 1 1/2	50	SQ075070	3/4-10 X 7	10
SQ062017	5/8-11 X1 3/4	50	SQ075075	3/4-10 X 7 1/2	10
SQ062020	5/8-11 X 2	25	SQ075080	3/4-10 X 8	10
SQ062022	5/8-11 X 2 1/4	25	SQ087020	7/8-9 X 2	10



Tel.: (819) 346-2903 / (888) 345-2903 Fax.: (819) 346-3389

Email: distributeur@boulonstrie.com

B-76

VIS DE PRESSION
 À TÊTE CARRÉE
 GROS FILETS

NOIR / BARE

SQUARE HEAD
 SET SCREWS
 NATIONAL COARSE

LA FINITION PLAQUÉE ZINC
 EST DISPONIBLE
 SUR DEMANDE



ZINC PLATED AVAILABLE
 ON REQUEST

NOTRECODE	DESCRIPTION	QTÉ/BTE
OUR CODE	DESCRIPTION	QTY/BOX
SQ087025	7/8-9 X 2 1/2	10
SQ087030	7/8-9 X 3	10
SQ087035	7/8-9 X 3 1/2	10
SQ087040	7/8-9 X 4	10
SQ087045	7/8-9 X 4 1/2	10
SQ087050	7/8-9 X 5	10
*****	7/8-9 X 5 1/2	10
SQ087060	7/8-9 X 6	10
SQ087070	7/8-9 X 7	10
SQ087080	7/8-9 X 8	10
SQ090020	1-8 X 2	10
SQ090025	1-8 X 2 1/2	10
SQ090030	1-8 X 3	10
SQ090035	1-8 X 3 1/2	10
SQ090040	1-8 X 4	10
*****	1-8 X 4 1/2	10
*****	1-8 X 5	10
SQ090055	1-8 X 5 1/2	10
SQ090060	1-8 X 6	10
SQ090070	1-8 X 7	10
SQ090080	1-8 X 8	10
SQ090100	1-8 X 10	10

**AUSSI DISPONIBLE /
 ALSO AVAILABLE**

MÉTRIQUE DIN 479 METRIC

ET

**ACIER INOXYDABLE
 SS-304 / 18-8**

**STAINLESS STEEL
 SS-304 / 18-8**

AUTRES DIMENSIONS DISPONIBLES / OTHER DIMENSIONS ARE AVAILABLE



Tel.: (819) 346-2903 / (888) 345-2903 Fax.: (819) 346-3389

Email: distributeur@boulonsestrie.com

B-77

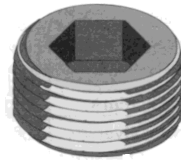

NOTRE CODE	DESCRIPTION	QTÉ/BTE
OUR CODE	DESCRIPTION	QTY/BOX
PP000062	1/16 NPT	100
PP000125	1/8 NPT	100
PP000250	1/4 NPT	100
PP000375	3/8 NPT	100
PP000500	1/2 NPT	100
PP000750	3/4 NPT	100
PP001000	1 NPT	100
PP001250	1 1/4 NPT	100
PP001500	1 1/2 NPT	100
*****	2 NPT	100

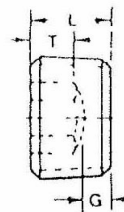
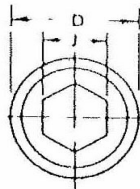

Nominal Size	D Nominal O. D.	Threads Per Inch	J Hexagon Socket Size Nominal	T Key Engagement Minimum	G Wall Thickness Minimum	L Overall Length			Tightening Torque Inch-Lbs.
						Nominal	Maximum	Minimum	
1/16	0,312	27	5/32	0,140	0,062	5/16	0,324	0,300	150
1/8	0,405	27	3/16	0,140	0,062	5/16	0,324	0,300	250
1/4	0,540	18	1/4	0,218	0,073	7/16	0,457	0,417	600
3/8	0,675	18	5/16	0,250	0,084	1/2	0,520	0,480	1200
1/2	0,840	14	3/8	0,312	0,095	9/16	0,583	0,542	1800
3/4	1,050	14	9/16	0,312	0,125	5/8	0,645	0,605	3000
1	1,315	11-1/2	5/8	0,375	0,125	3/4	0,770	0,730	4200
1-1/4	1,660	11-1/2	3/4	0,437	0,156	13/16	0,832	0,792	5400
1-1/2	1,900	11-1/2	1	0,437	0,156	13/16	0,843	0,780	6900
2	2,375	11-1/2	1	0,437	0,156	7/8	0,906	0,844	8500

AUSSI DISPONIBLE / ALSO AVAILABLE

ACIER INOXYDABLE ET MÉTRIQUE / METRIC AND STAINLESS STEEL

LAITON / BRASS

BOUCHONS FILETÉS 7/8 HEXAGONE / PIPE PLUGS HEX 7/8

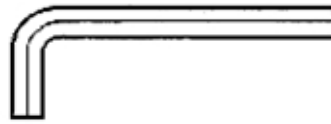

NOTRE CODE (COURTE)	NOTRE CODE (LONGUE)	DESCRIPTION	QUANTITÉ PAR PAQUET
OUR CODE (SHORT)	OUR CODE (LONG)	DESCRIPTION	UNIT PACKAGE QUANTITY
AK100028	-	.028	1
AK100035	AK200035	.035	1
AK100050	AK200050	.050	1
AK100062	AK200062	1/16	1
AK100078	AK200078	5/64	1
AK100093	AK200093	3/32	1
AK100109	AK200109	7/64	1
AK100125	AK200125	1/8	1
AK100140	AK200140	9/64	1
AK100156	AK200156	5/32	1
AK100187	AK200187	3/16	1
AK100218	AK200218	7/32	1
AK100250	AK200250	1/4	1
AK100315	AK200315	5/16	1
AK100375	AK200375	3/8	1
AK100437	AK200437	7/16	1
AK100500	AK200500	1/2	1
AK100562	AK200562	9/16	1
AK100625	AK200625	5/8	1
AK100750	AK200750	3/4	1
AK100875	AK200875	7/8	1
AK101000	AK201000	1	1





POUR LONGUEURS VOIR TECHNIQUE B (T-9) / ***FOR LENGTH SEE TECHNICAL B (T-9)***

NOTRE CODE (COURTE)	NOTRE CODE (LONGUE)	DESCRIPTION	QTÉ/BTE
OUR CODE (SHORT)	OUR CODE (LONG)	DESCRIPTION	QTY/BOX
AK400015	AK500015	1.5 mm	100
AK400020	AK500020	2 mm	100
AK400025	AK500025	2.5 mm	100
AK400030	AK500030	3 mm	100
AK400040	AK500040	4 mm	100
AK400050	AK500050	5 mm	100
AK400060	AK500060	6 mm	100
AK400070	AK500070	7 mm	100
AK400080	AK500080	8 mm	100
-	AK500090	9 mm	100
AK400100	AK500100	10 mm	100
-	AK500110	11 mm	100
AK400120	AK500120	12 mm	50
AK400140	AK500140	14 mm	50
-	AK500170	17 mm	50
AK400190	AK500190	19 mm	25

AUTRES DIMENSIONS DISPONIBLES / OTHER DIMENSIONS ARE AVAILABLE

CLÉS HEXAGONALES
BOUT EN ROND



HEX KEYS "ALLEN"
BALL POINT

NOTRE CODE	DESCRIPTION	FORMAT
OUR CODE	DESCRIPTION	PACKAGE
AK600015	1.5 mm	1
AK600020	2 mm	1
AK600025	2.5 mm	1
AK600040	4 mm	1
AK600060	6 mm	1
AK600080	8 mm	1
AK600100	10 mm	1



Tel.: (819) 346-2903 / (888) 345-2903 Fax.: (819) 346-3389
Email: distributeur@boulonsestrie.com

CLÉS HEXAGONALES
BOUT EN ROND



HEX KEYS "ALLEN"
BALL POINT

NOTRE CODE	DIM. DE LA CLÉ	LONGUEUR
OUR CODE	KEY SIZE	LENGHT
AK30050	.050"	2-13/16"
*****	1/16	3"
AK30078	5/64	3-3/16"
*****	3/32	3-13/32"
*****	7/64	3-19/32"
*****	1/8	3-13/16"
AK300140	9/64	3-29/32"
*****	5/32	4-3/32"
*****	3/16	4-1/2"
*****	7/32	4-29/32"
*****	1/4	5-3/16"
AK300315	5/16	6"
*****	3/8	6-13/16"
*****	7/16	7-1/2"
*****	1/2	8-5/16"
*****	9/16	9"
*****	5/8	9-13/16"
*****	3/4	11-5/16"

TOURNEVIS HEXAGONE
BOUT EN ROND



HEX SCREWDRIVERS
BALL POINT

NOTRE CODE	DIM. DE LA CLÉ	LONGUEUR DE LA LAME
OUR CODE	KEY SIZE	BLADE LENGHT
AK350050	.050"	4-11/16"
AK350062	1/16"	4-13/16"
AK350218	7/32"	7-11/16"
AK350250	1/4"	8-13/16"
AK350315	5/16"	9-13/32"
AK350375	3/8"	10-13/32"

AUTRES DIMENSIONS DISPONIBLES/OTHER DIMENSIONS ARE AVAILABLE



Tel.: (819) 346-2903 / (888) 345-2903 Fax.: (819) 346-3389
Email: distributeur@boulonsestrie.com

B-81

INDIVIDUELLE / INDIVIDUAL

NOTRE CODE	DESCRIPTION
OUR CODE	DESCRIPTION
AK700093	3/32 X 9"
AK700109	7/64 X 4"
AK100124	1/8 X 4.6"
AK700125	1/8 X 7.6"
AK700126	1/8 X 9"
AK700140	9/64 X 4.5"
AK700156	5/32 X 5.2"
AK700187	3/16 X 6"
AK700218	7/32 X 6"
AK700312	5/16 X 6"



ENS. DE CLÉS HEXAGONALES MANCHE EN T

ALLEN KEYS T-HANDLE SETS

ENSEMBLES / SETS

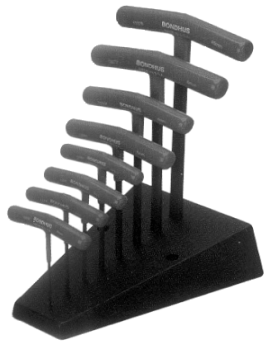

JEUX DE CLÉS
HEX BOUT
ROND ZINC

ALLEN KEYS SETS
BALL DRIVER
PLATED

NOTRE CODE	DESCRIPTION
OUR CODE	DESCRIPTION
OU016937	.050 À 3/8
OU017099	1.5 mm à 10 mm

NOTRE CODE	DESCRIPTION
OUR CODE	DESCRIPTION
OU013138	3/32 À 3/8
OU013189	2 mm À 10 mm
OU013190	3/32 À 3/8 W/S



ENS. CLÉS HEX
BOUT ROND
NOIR

ALLEN KEYS SETS
BALL DRIVER
PLAIN

"L"



NOTRE CODE	DESCRIPTION
OUR CODE	DESCRIPTION
OU010932	.050 À 5/32
OU010937	.050 À 3/8
OU010999	1.5 mm À 10 mm



ENS. CLÉS
HEXAGONALES

ALLEN KEY
SETS HEX

"L"

NOTRE CODE	DESCRIPTION
OU012137	.050 À 3/8
OU012199	1.5 mm À 10 mm

ENS. CLÉS HEXAGONALES / HEX FOLD UP

NOTRE CODE	DESCRIPTION	ENS. CLÉS TORX	DESCRIPTION
REF.: 12550	Combo (5/64 à 5/32) & 1.5 mm à 5 mm		
OU012585	3/16 À 3/8		
OU012587	2 mm À 8 mm	OU012634	TORX T9 X T40
OU012589	5/64 À 1/4		
OU012591	.050 À 3/16		
OU012592	1.5 mm À 6 mm		
OU012595	3 mm À 10 mm		
		CLÉS BALL POINT	DESCRIPTION
		OU012894	3/16 À 3/8

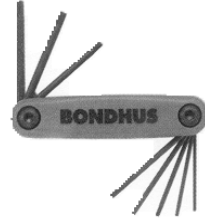

ENSEMBLES / SETS

TOURNEVIS
BOUT RONDS

BALL POINT
SCREWDRIVERS

NOTRE CODE	DESCRIPTION
OU010632	.050 À 5/32
OU010637	.050 À 3/8
OU010686	1.5 mm À 5 mm
OU010699	1.5 mm À 10 mm



ENSEMBLE DOUBLE DE CLÉS HEXAGONALES À BOUT ROND NOIR /
DOUBLE PACK ALLEN KEY SETS BALL DRIVER PLAIN

NOTRE CODE	DESCRIPTION
OU022199	OU010999 (1.5 mm à 10 mm) & OU010937 (0.050 à 5/32)

ENSEMBLE DOUBLE DE CLÉS HEXAGONALES /
DOUBLE PACK ALLEN KEY SETS HEX

NOTRE CODE	DESCRIPTION
OU020199	OU012137 (0.050 à 3/8) & OU012199 (1.5mm à 10 mm)



ENSEMBLE TRIPLE DE CLÉS HEXAGONALES À BOUT ROND NOIR & CLÉS HEX /
TRIPLE PACK ALLEN KEY SETS BALL DRIVER PLAIN & HEX FOLD UP





NOTRE CODE	DESCRIPTION
OU014130	OU010937 (0.050 à 5/32) & OU010999 (1.5 mm à 10 mm) & OU012550 (5/64 à 5/32 & 1.5 mm à 5mm)



SECTION C











ÉCROUS / NUTS

INFORMATION TECHNIQUE.....DÉBUT DE LA SECTION
 TECHNICAL INFORMATION.....BEGINNING OF THIS SECTION

	DESCRIPTION	SECTION - PAGE
	ÉCROUS HEXAGONAUX, GRADE 2, <i>GROS FILETS & FINS</i> , NOIR. HEX NUTS, GRADE 2, <i>NATIONAL COARSE & FINE</i> , BARE.	C-1
	ÉCROUS HEXAGONAUX, GRADE 5, <i>GROS FILETS & FINS</i> , NOIR. HEX NUTS, GRADE 5, <i>NATIONAL COARSE & FINE</i> , BARE.	C-2
	ÉCROUS HEXAGONAUX, GRADE 8, <i>GROS FILETS & FINS</i> , NOIR. HEX NUTS, GRADE 8, <i>NATIONAL COARSE & FINE</i> , BARE.	C-3
	ÉCROUS HEXAGONAUX, GRADE 2, <i>GROS FILETS & FINS</i> , ZINC. HEX NUTS, GRADE 2, <i>NATIONAL COARSE & FINE</i> , PLATED.	C-4
	ÉCROUS HEXAGONAUX, GRADE 5, <i>GROS FILETS & FINS</i> , ZINC. HEX NUTS, GRADE 5, <i>NATIONAL COARSE & FINE</i> , PLATED.	C-5
	ÉCROUS HEXAGONAUX, GRADE 8, <i>GROS FILETS & FINS</i> , ZINC. HEX NUTS, GRADE 8, <i>NATIONAL COARSE & FINE</i> , PLATED.	C-6
	ÉCROUS HEXAGONAUX, <i>GROS FILETS & FINS</i> , L-9. HEX NUTS, <i>NATIONAL COARSE & FINE</i> , L-9.	C-7
	ÉCROUS FILET À GAUCHE, <i>GROS FILETS & FINS</i> , NOIR. LEFT HAND NUTS, <i>NATIONAL COARSE & FINE</i> , BARE.	C-7
	ÉCROUS HEXAGONAUX, <i>GROS FILETS</i> , SS-304. HEX NUTS, <i>NATIONAL COARSE</i> , SS-304.	C-8
	ÉCROUS HEXAGONAUX, <i>FILETS FINS</i> , SS-304. HEX NUTS, <i>NATIONAL FINE</i> , SS-304.	SUR DEMANDE ON REQUEST
	ÉCROUS HEXAGONAUX, <i>GROS FILETS</i> , SS-316. HEX NUTS, <i>NATIONAL COARSE</i> , SS-316.	C-8

SECTION C

ÉCROUS / NUTS

	DESCRIPTION	SECTION - PAGE
	ÉCROUS HEXAGONAUX, <i>FILETS FINS</i> , SS-316. HEX NUTS, <i>NATIONAL FINE</i> , SS-316.	SUR DEMANDE ON REQUEST
	ÉCROUS HEXAGONAUX, <i>GROS FILETS</i> , LAITON. HEX NUTS, <i>NATIONAL COARSE</i> , BRASS.	C-9
	ÉCROUS HEXAGONAUX, <i>GROS FILETS</i> , H.D.G. HEX NUTS, <i>NATIONAL COARSE</i> , H.D.G.	C-9
	ÉCROUS HEXAGONAUX, CLASSE 8,8, MÉTRIQUE, <i>GROS FILETS</i> , NOIR. HEX NUTS, CLASSE 8,8, METRIC, <i>NATIONAL COARSE</i> , BARE.	C-10
	ÉCROUS HEXAGONAUX, CLASSE 8,8, MÉTRIQUE, <i>FILETS FINS</i> , NOIR. HEX NUTS, CLASSE 8,8, METRIC, <i>NATIONAL FINE</i> , BARE.	C-10
	ÉCROUS HEXAGONAUX, CLASSE 8,8, MÉTRIQUE, <i>GROS FILETS</i> , ZINC. HEX NUTS, CLASSE 8,8, METRIC, <i>NATIONAL COARSE</i> , PLATED.	C-10
	ÉCROUS HEXAGONAUX, CLASSE 8,8, MÉTRIQUE, <i>FILETS FINS</i> , ZINC. HEX NUTS, CLASSE 8,8, METRIC, <i>NATIONAL FINE</i> , PLATED.	SUR DEMANDE ON REQUEST
	ÉCROUS HEXAGONAUX, CLASSE 10,9, MÉTRIQUE, <i>GROS FILETS</i> , ZINC. HEX NUTS, <i>METRIC</i> , CLASS 10.9, <i>NATIONAL COARSE</i> , PLATED.	C-11
	ÉCROUS HEXAGONAUX, CLASSE 10,9, MÉTRIQUE, <i>FILETS FINS</i> , NOIR. HEX NUTS, CLASS 10.9, METRIC, <i>NATIONAL FINE</i> , BARE.	SUR DEMANDE ON REQUEST
	ÉCROUS HEXAGONAUX, CLASSE 10,9, MÉTRIQUE, <i>FILETS FINS</i> , ZINC. HEX NUT, CLASS 10.9, METRIC, <i>NATIONAL FINE</i> , PLATED.	SUR DEMANDE ON REQUEST
	ÉCROUS HEXAGONAUX, MÉTRIQUE, SS-304, <i>GROS FILETS</i> . HEX NUTS, METRIC, SS-304, NATIONAL COARSE.	C-11
	ÉCROUS À CHAPE, <i>GROS FILETS</i> , ZINC. ACORN NUTS, <i>NATIONAL COARSE</i> , PLATED.	C-12













SECTION C

ÉCROUS / NUTS

	DESCRIPTION	SECTION - PAGE
	ÉCROUS À CHAPE, <i>FILETS FINS</i> , ZINC . ACORN NUTS, <i>NATIONAL FINE</i> , PLATED.	SUR DEMANDE ON REQUEST
	ÉCROUS À CHAPE, <i>GROS FILETS</i> , SS-304. ACORN NUTS, <i>NATIONAL COARSE</i> , SS-304.	SUR DEMANDE ON REQUEST
	ÉCROUS À COLERETTE, <i>GROS FILETS</i> , ZINC. FLANGE NUTS, <i>NATIONAL COARSE</i> , PLATED.	C-12
	ÉCROUS À COLERETTE, <i>FILETS MÉTRIQUES</i> , ZINC. FLANGE NUTS, <i>METRIC THREAD</i> , PLATED.	SUR DEMANDE ON REQUEST
	ÉCROUS À COLERETTE, <i>GROS FILETS</i> , SS-304. FLANGE NUTS, <i>NATIONAL COARSE</i> , SS-304.	SUR DEMANDE ON REQUEST
	CONTRE-ÉCROUS HEXAGONAUX, <i>GROS FILETS</i> , NOIR & ZINC. HEX JAM NUTS, <i>NATIONAL COARSE</i> , BARE & PLATED.	C-13
	CONTRE-ÉCROUS HEXAGONAUX, <i>FILETS FINS</i> , NOIR & ZINC. HEX JAM NUTS, <i>NATIONAL FINE</i> , BARE & PLATED.	C-13
	CONTRE-ÉCROUS HEXAGONAUX, <i>GROS FILETS & FINS</i> , SS-304. HEX JAM NUTS, <i>NATIONAL COARSE & FINE</i> , SS-304.	C-14
	CONTRE-ÉCROUS HEXAGONAUX, <i>GROS FILETS & FINS</i> , SS-316. HEX JAM NUTS, <i>NATIONAL COARSE & FINE</i> , SS-316.	SUR DEMANDE ON REQUEST
	ÉCROUS DE BLOCAGE, GRADE 2, <i>GROS FILETS</i> , ZINC. INSERT LOCKNUTS, GRADE 2, <i>NATIONAL COARSE</i> , PLATED.	C-15
	ÉCROUS DE BLOCAGE, GRADE 5, <i>GROS FILETS</i> , ZINC. INSERT LOCKNUTS, GRADE 5, <i>NATIONAL COARSE</i> , PLATED.	SUR DEMANDE ON REQUEST
	ÉCROUS DE BLOCAGE, GRADE 8, <i>GROS FILETS</i> , ZINC. INSERT LOCKNUTS, GRADE 8, <i>NATIONAL COARSE</i> , PLATED.	SUR DEMANDE ON REQUEST







SECTION C

ÉCROUS / NUTS

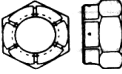
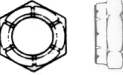
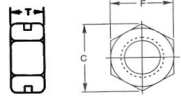
DESCRIPTION	SECTION - PAGE
 <p>ÉCROUS DE BLOCAGE, GRADE 2, <i>FILETS FINS</i>, ZINC. INSERT LOCKNUTS, GRADE 2, <i>NATIONAL FINE</i>, PLATED.</p>	C-16
 <p>ÉCROUS DE BLOCAGE, GRADE 5, <i>FILETS FINS</i>, ZINC. INSERT LOCKNUTS, GRADE 5, <i>NATIONAL FINE</i>, PLATED.</p>	SUR DEMANDE ON REQUEST
 <p>ÉCROUS DE BLOCAGE, GRADE 8, <i>FILETS FINS</i>, ZINC. INSERT LOCKNUTS, GRADE 8, <i>NATIONAL FINE</i>, PLATED.</p>	SUR DEMANDE ON REQUEST
 <p>ÉCROUS INDESSERRABLES, <i>GROS FILETS</i>, SS-304. NYLON LOCKNUTS, <i>NATIONAL COARSE</i>, SS-304.</p>	C-17
 <p>ÉCROUS INDESSERRABLES, <i>FILETS FINS</i>, SS-304. NYLON LOCK NUTS, <i>NATIONAL FINE</i>, SS-304.</p>	SUR DEMANDE ON REQUEST
 <p>ÉCROUS INDESSERRABLES, <i>GROS FILETS & FINS</i>, SS-316. NYLON LOCKNUTS, <i>NATIONAL COARSE & FINE</i>, SS-316.</p>	SUR DEMANDE ON REQUEST
 <p>ÉCROUS INDESSERRABLES, MÉTRIQUE, <i>GROS FILETS</i>, ZINC. NYLON LOCKNUTS, METRIC, <i>NATIONAL COARSE</i>, PLATED.</p>	C-18
 <p>ÉCROUS INDESSERRABLES, MÉTRIQUE, <i>FILETS FINS</i>, ZINC. NYLON LOCKNUTS, METRIC, <i>NATIONAL FINE</i>, PLATED.</p>	SUR DEMANDE ON REQUEST
 <p>ÉCROUS INDESSERRABLES, MÉTRIQUE, SS-304. NYLON LOCKNUTS, METRIC, SS-304.</p>	C-18
 <p>ÉCROUS INDESSERRABLES, MÉTRIQUE, SS-316. NYLON LOCKNUTS, METRIC, SS-316.</p>	SUR DEMANDE ON REQUEST
 <p>ÉCROUS INDESSERRABLES, GRADE C, <i>GROS FILETS & FINS</i>, ZINC. STOVER LOCKNUTS, GRADE C, <i>NATIONAL COARSE & FINE</i>, PLATED.</p>	C-19
 <p>ÉCROUS INDESSERRABLES, L-9, <i>GROS FILETS & FINS</i>, ZINC. STOVER LOCKNUTS, L-9, <i>NATIONAL COARSE & FINE</i>, PLATED.</p>	C-20



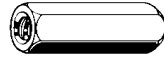
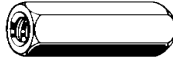









SECTION C

ÉCROUS / NUTS

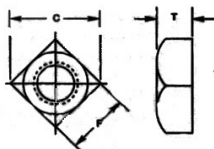
DESCRIPTION	SECTION - PAGE
	<p>ÉCROUS DE NYLON <u>MINCE</u> INDESSERABLES, GRADE 2, <i>FILET GROS & FINS</i>, ZINC. <u>HALF</u> NYLON LOCKNUTS, GR. 2, <i>NATIONAL COARSE</i>, PLATED.</p> <p style="text-align: right;">C-21</p>
	<p>FLEX LOCKNUTS.</p> <p style="text-align: right;">SUR DEMANDE ON REQUEST</p>
	<p>HALF FLEX LOCKNUTS.</p> <p style="text-align: right;">SUR DEMANDE ON REQUEST</p>
	<p>ÉCROUS RÉVERSIBLES À DEUX SENS. REVERSIBLE (TWO WAY) LOCKNUTS.</p> <p style="text-align: right;">SUR DEMANDE ON REQUEST</p>
	<p>ÉCROUS CHÂTEAU, <i>GROS FILETS & FINS</i>, NOIR. CASTLE NUTS, <i>NATIONAL COARSE & FINE</i>, BARE.</p> <p style="text-align: right;">C-22</p>
	<p>ÉCROUS CHÂTEAU, <i>GROS FILETS & FINS</i>, ZINC. CASTLE NUTS, <i>NATIONAL COARSE & FINE</i>, PLATED.</p> <p style="text-align: right;">SUR DEMANDE ON REQUEST</p>
	<p>ÉCROUS TRÈS HAUTS. DEEP NUTS.</p> <p style="text-align: right;">C-22</p>
	<p>ÉCROUS DE RACCORD, <i>GROS FILETS</i>, ZINC. COUPLING NUTS, <i>NATIONAL COARSE</i>, PLATED.</p> <p style="text-align: right;">C-23</p>
	<p>ÉCROUS DE RACCORD, <i>FILETS FINS</i>, ZINC. COUPLING NUTS, <i>NATIONAL FINE</i>, PLATED.</p> <p style="text-align: right;">SUR DEMANDE ON REQUEST</p>
	<p>ÉCROUS DE RACCORD, <i>GROS FILETS</i>, SS-304. COUPLING NUTS, <i>NATIONAL COARSE</i>, SS-304.</p> <p style="text-align: right;">SUR DEMANDE ON REQUEST</p>
	<p>ÉCROUS DE RACCORD, <i>FILETS À GAUCHE</i>, PLATED. COUPLING NUTS, <i>LEFT HAND</i>, PLATED.</p> <p style="text-align: right;">SUR DEMANDE ON REQUEST</p>
	<p>ÉCROUS "ACME". ACME NUTS.</p> <p style="text-align: right;">C-24</p>

SECTION C

ÉCROUS / NUTS

	DESCRIPTION	SECTION - PAGE
	ÉCROUS DE STRUCTURE, A563-C, NOIR. HEX STRUCTURAL NUTS, A563-C, BARE.	C-24
	ÉCROUS DE STRUCTURE, A563-C, ZINC. HEX STRUCTURAL NUTS, A563-C, PLATED.	SUR DEMANDE ON REQUEST
	ÉCROUS DE STRUCTURE, A563-C, H.D.G. HEX STRUCTURAL NUTS, A563-C, H.D.G.	SUR DEMANDE ON REQUEST
	ÉCROUS HEXAGONAUX LARGES, A194-2H. HEAVY HEX NUTS, A194-2H.	C-26
	ÉCROUS HEXAGONAUX LARGES, <i>GROS FILETS</i> , NOIR & ZINC. HEAVY HEX NUTS, <i>NATIONAL COARSE</i> , BARE & PLATED.	C-26
	ÉCROUS HEXAGONAUX LARGES, <i>GROS FILETS</i> , SS-304. HEAVY HEX NUTS, <i>NATIONAL COARSE</i> , SS-304.	SUR DEMANDE ON REQUEST
	ÉCROUS HEXAGONAUX LARGES, <i>GROS FILETS</i> , SS-316. HEAVY HEX NUTS, <i>NATIONAL COARSE</i> , SS-316.	SUR DEMANDE ON REQUEST
	ÉCROUS CARRÉS RÉGULIERS. REGULAR SQUARE NUTS.	C-25
	ÉCROUS PAPILLONS, <i>GROS FILETS</i> , ZINC. WING NUTS, <i>NATIONAL COARSE</i> , PLATED.	C-27
	ÉCROUS PAPILLON, <i>GROS FILETS</i> , SS-304. WING NUTS, <i>NATIONAL COARSE</i> , SS-304.	SUR DEMANDE ON REQUEST
	ÉCROUS À BOIS, <i>GROS FILETS</i> , ZINC. TEENUTS, <i>NATIONAL COARSE</i> , PLATED.	C-27
	ÉCROUS À BOIS, <i>GROS FILETS</i> , NOIR. TEENUTS, <i>NATIONAL COARSE</i> , PLAIN.	SUR DEMANDE ON REQUEST
	ÉCROUS À OEIL, FORGÉS. FORGED EYE NUTS.	C-28



NC

NF

NOTRE CODE	DESCRIPTION	NOTRE CODE	DESCRIPTION	PLAT À PLAT	ÉPAISSEUR
OUR CODE	DESCRIPTION	OUR CODE	DESCRIPTION	ACROSS FLAT	THICKNESS
NN400250	1/4-20	NN100250	1/4-28	7/16	7/32
NN400315	5/16-18	NN100315	5/16-24	1/2	17/64
NN400375	3/8-16	NN100375	3/8-24	9/16	21/64
NN400437	7/16-14	NN100437	7/16-20	11/16	3/8
NN400500	1/2-13	NN100500	1/2-20	3/4	7/16
NN400562	9/16-12	NN100562	9/16-18	7/8	31/64
NN400625	5/8-11	NN100625	5/8-18	15/16	35/64
NN400750	3/4-10	NN100750	3/4-16	1 1/8	41/64
NN400875	7/8-9	NN100875	7/8-14	1 5/16	3/4
NN401000	1-8	NN101012(-14)	1-12 (1-14)	1 1/2	55/64
NN401125	1 1/8-7	NN101125	1 1/8-12	1 11/16	31/32
NN401250	1 1/4-7	NN101250	1 1/4-12	1 7/8	1 1/16
NN401375	1 3/8-6	NN101375	1 3/8-12	2 1/16	1 11/64
NN401500	1 1/2-6	NN101500	1 1/2-12	2 1/4	1 9/32
NN401625	1 5/8-6	NN101625	1 5/8-12	-	-
NN401750	1 3/4-5	NN101750	1 3/4-12	-	-
NN401875	1 7/8-5	-	-	-	-
NN402000	2- 4 1/2	NN102000	2-12	-	-

AUTRES DIMENSIONS DISPONIBLES/OTHER DIMENSIONS ARE AVAILABLE

BOITE STANDARD/STANDARD BOX	
DIA.	QTÉ/QTY
1/4	100
5/16	100
3/8	100
7/16	50
1/2	50
9/16	25
5/8	25
3/4	20
7/8	20
1	20
1 1/8	15
1 1/4	15
1 1/2	10



Tel.: (819) 346-2903 / (888) 345-2903 Fax.: (819) 346-3389
Email: distributeur@boulonstrie.com



NC		NF		PLAT À PLAT	ÉPAISSEUR
NOTRE CODE	DESCRIPTION	NOTRE CODE	DESCRIPTION	ACROSS FLAT	THICKNESS
NN500250	1/4-20	NN600250	1/4-28	7/16	7/32
NN500315	5/16-18	*****	5/16-24	1/2	17/64
NN500375	3/8-16	NN600375	3/8-24	9/16	21/64
NN500437	7/16-14	NN600437	7/16-20	11/16	3/8
NN500500	1/2-13	NN600500	1/2-20	3/4	7/16
NN500562	9/16-12	NN600562	9/16-18	7/8	31/64
NN500625	5/8-11	NN600625	5/8-18	15/16	35/64
NN500750	3/4-10	NN600750	3/4-16	1 1/8	41/64
NN500875	7/8-9	NN600875	7/8-14	1 5/16	3/4
NN501000	1-8	*****	1-12	1 1/2	55/64
NN501125	1 1/8-7	*****	1 1/8-12	1 11/16	31/32
NN501250	1 1/4-7	NN601250	1 1/4-12	1 7/8	1 1/16
NN501500	1 1/2-6	*****	1 1/2 -12	2 1/4	1 9/32

AUTRES DIMENSIONS DISPONIBLES /OTHER DIMENSIONS ARE AVAILABLE

BOITE STANDARD/STANDARD BOX	
DIA.	QTÉ/QTY
1/4	100
5/16	100
3/8	100
7/16	50
1/2	50
9/16	25
5/8	25
3/4	20
7/8	20
1	20
1 1/8	15
1 1/4	15
1 1/2	10





NC

NF

NOTRE CODE	DESCRIPTION	NOTRE CODE	DESCRIPTION	PLAT À PLAT	ÉPAISSEUR
OUR CODE	DESCRIPTION	OUR CODE	DESCRIPTION	ACROSS FLAT	THICKNESS
NN200250	1/4-20	NN300250	1/4-28	7/16	7/32
NN200315	5/16-18	NN300315	5/16-24	1/2	17/64
NN200375	3/8-16	NN300375	3/8-24	9/16	21/64
NN200437	7/16-14	NN300437	7/16-20	11/16	3/8
NN200500	1/2-13	NN300500	1/2-20	3/4	7/16
NN200562	9/16-12	NN300562	9/16-18	7/8	31/64
NN200625	5/8-11	NN300625	5/8-18	15/16	35/64
NN200750	3/4-10	NN300750	3/4-16	1 1/8	41/64
NN200875	7/8-9	NN300875	7/8-14	1 5/16	3/4
NN201000	1-8	NN301000	1-14	1 1/2	55/64
NN201125	1 1/8-7	NN301125	1 1/8-12	1 11/16	31/32
NN201250	1 1/4-7	NN301250	1 1/4-12	1 7/8	1 1/16
NN201500	1 1/2-6	NN301500	1 1/2-12	2 1/4	1 9/32

AUTRES DIMENSIONS DISPONIBLES /OTHER DIMENSIONS ARE AVAILABLE

BOITE STANDARD/STANDARD BOX	
DIA.	QTÉ/QTY
1/4	100
5/16	100
3/8	100
7/16	50
1/2	50
9/16	25
5/8	25
3/4	20
7/8	20
1	20
1 1/8	15
1 1/4	15
1 1/2	10



Tel.: (819) 346-2903 / (888) 345-2903 Fax.: (819) 346-3389

Email: distributeur@boulonsestrie.com



NC

NF

NOTRE CODE	DESCRIPTION	NOTRE CODE	DESCRIPTION	PLAT À PLAT	ÉPAISSEUR
OUR CODE	DESCRIPTION	OUR CODE	DESCRIPTION	ACROSS FLAT	THICKNESS
NZ200003	3-48	*****	3-56	3/16	1/16
NZ200004	4-40	*****	4-48	1/4	3/32
NZ200006	6-32	*****	6-40	5/16	7/64
NZ200008	8-32	NZ100008	8-36	11/32	1/8
NZ200010	10-24	NZ100011	10-32	3/8	1/8
NZ200012	12-24	NZ100012	12-28	7/16	5/32
NZ200250	1/4-20	NZ100250	1/4-28	7/16	7/32
NZ200315	5/16-18	NZ100315	5/16-24	1/2	17/64
NZ200375	3/8-16	NZ100375	3/8-24	9/16	21/64
NZ200437	7/16-14	NZ100437	7/16-20	11/16	3/8
NZ200500	1/2-13	NZ100500	1/2-20	3/4	7/16
NZ200562	9/16-12	NZ100562	9/16-18	7/8	31/64
NZ200625	5/8-11	NZ100625	5/8-18	15/16	35/64
NZ200750	3/4-10	NZ100750	3/4-16	1 1/8	41/64
NZ200875	7/8-9	NZ100875	7/8-14	1 5/16	3/4
NZ201000	1-8	NZ101000	1-14	1 1/2	55/64
NZ201125	1 1/8-7	NZ101125	1 1/8-12	1 11/16	31/32
NZ201250	1 1/4-7	NZ101250	1 1/4-12	1 7/8	1 1/16
NZ201500	1 1/2-6	*****	1 1/2-12	2 1/4	1 9/32

AUTRES DIMENSIONS DISPONIBLES/OTHER DIMENSIONS ARE AVAILABLE

BOITE STANDARD/STANDARD BOX	
DIA.	QTÉ/PTY
1/4	100
5/16	100
3/8	100
7/16	50
1/2	50
9/16	25
5/8	25
3/4	20
7/8	20
1	20
1 1/8	15
1 1/4	15
1 1/2	10



Tel.: (819) 346-2903 / (888) 345-2903 Fax.: (819) 346-3389

Email: distributeur@boulonstrie.com



NC

NF

NOTRE CODE	DESCRIPTION	NOTRE CODE	DESCRIPTION	PLAT À PLAT	ÉPAISSEUR
OUR CODE	DESCRIPTION	OUR CODE	DESCRIPTION	ACROSS FLAT	THICKNESS
NZ400250	1/4-20	NZ300250	1/4-28	7/16	7/32
NZ400315	5/16-18	NZ300315	5/16-24	1/2	17/64
NZ400375	3/8-16	NZ300375	3/8-24	9/16	21/64
NZ400437	7/16-14	NZ300437	7/16-20	11/16	3/8
NZ400500	1/2-13	NZ300500	1/2-20	3/4	7/16
NZ400562	9/16-12	NZ300562	9/16-18	7/8	31/64
NZ400625	5/8-11	NZ300625	5/8-18	15/16	35/64
NZ400750	3/4-10	NZ300750	3/4-16	1 1/8	41/64
NZ400875	7/8-9	*****	7/8-14	1 5/16	3/4
NZ401000	1-8	NZ301000	1-14	1 1/2	55/64
NZ401125	1 1/8-7	*****	1 1/8-12	1 11/16	31/32
NZ401250	1 1/4-7	*****	1 1/4-12	1 7/8	1 1/16

AUTRES DIMENSIONS DISPONIBLES/OTHER DIMENSIONS ARE AVAILABLE

BOITE STANDARD / STANDARD BOX	
DIA.	QTÉ/QTY
1/4	100
5/16	100
3/8	100
7/16	50
1/2	50
9/16	25
5/8	25
3/4	20
7/8	20
1	20
1 1/8	15
1 1/4	15
1 1/2	10





NC		NF		PLAT À PLAT	ÉPAISSEUR
NOTRE CODE	DESCRIPTION	NOTRE CODE	DESCRIPTION	ACROSS FLAT	THICKNESS
NZ600250	1/4-20	NZ610250	1/4-28	7/16	7/32
NZ600315	5/16-18	NZ610315	5/16-24	1/2	17/64
NZ600375	3/8-16	NZ610375	3/8-24	9/16	21/64
NZ600437	7/16-14	NZ610437	7/16-20	11/16	3/8
NZ600500	1/2-13	NZ610500	1/2-20	3/4	7/16
NZ600562	9/16-12	*****	9/16-18	7/8	31/64
NZ600625	5/8-11	NZ610625	5/8-18	15/16	35/64
NZ600750	3/4-10	NZ610750	3/4-16	1 1/8	41/64
NZ600875	7/8-9	*****	7/8-14	1 5/16	3/4
NZ601000	1-8	NZ611000(01)	1-14 (1-12)	1 1/2	55/64
NZ601250	1 1/4-7	*****	1 1/4 -12	1 7/8	1 1/16
NZ601500	1 1/2-6	NZ611500	1 1/2-12	2 1/4	1 9/32

AUTRES DIMENSIONS DISPONIBLES/OTHERS DIMENSIONS ARE AVAILABLES

BOITE STANDARD/STANDARD BOX	
DIA.	QTÉ/QTY
1/4	100
5/16	100
3/8	100
7/16	50
1/2	50
9/16	25
5/8	25
3/4	20
7/8	20
1	20
1 1/8	15
1 1/4	15
1 1/2	10



ÉCROUS HEXAGONAUX

ZINC DICHROMATE

HEX NUTS

L-9



L-9

N.C.

N.F.

NOTRE CODE	DESCRIPTION	NOTRE CODE	DESCRIPTION	PLAT À PLAT	EPAISSEUR
OUR CODE	DESCRIPTION	OUR CODE	DESCRIPTION	ACROSS FLAT	THICKNESS
NZ900250	1/4-20	NZ800250	1/4-28	0,437 - 0,428	0,264 - 0,250
NZ900315	5/16-18	NZ800315	5/16-24	0,500 - 0,489	0,309 - 0,293
NZ900375	3/8-16	NZ800375	3/8-16	0,562 - 0,551	0,377 - 0,360
NZ900437	7/16-14	NZ800437	7/16-20	0,687 - 0,675	0,445 - 0,426
NZ900500	1/2-13	NZ800500	1/2-20	0,750 - 0,736	0,511 - 0,490
NZ900562	9/16-12	NZ800562	9/16-18	0,875 - 0,861	0,575 - 0,552
NZ900625	5/8-11	NZ800625	5/8-18	0,937 - 0,922	0,655 - 0,630
NZ900750	3/4-10	NZ800750	3/4-16	1,125 - 1,088	0,762 - 0,733
NZ900875	7/8-9	NZ800875	7/8-14	1,312 - 1,269	0,882 - 0,850
NZ901000	1-8	NZ801000	1-14	1,500 - 1,450	1,018 - 0,982
NZ901125	1 1/8-7	NZ801125	1 1/8-12	1,687 - 1,631	1,176 - 1,136
NZ901250	1 1/4-7	NZ801250	1 1/4-12	1,875 - 1,812	1,272 - 1,228
NZ901500	1 1/2-6	NZ801500	1 1/2-12	2,25 - 2,175	1,526 - 1,474

ÉCROUS HEXAGONAUX

NOIR/PLAIN

HEX NUTS

FILETS À GAUCHE



LEFT HAND THREADS

N.C.

N.F.

NOTRE CODE	DESCRIPTION	NOTRE CODE	DESCRIPTION	PLAT À PLAT	EPAISSEUR
OUR CODE	DESCRIPTION	OUR CODE	DESCRIPTION	ACROSS FLAT	THICKNESS
NN700250	1/4-20	*****	1/4-28	7/16	7/32
NN700315	5/16-18	NN750315	5/16-24	1/2	17/64
NN700375	3/8-16	NN750375	3/8-24	9/16	21/64
NN700437	7/16-14	NN750437	7/16-20	11/16	3/8
NN700500	1/2-13	*****	1/2-20	3/4	7/16
NN700625	5/8-11	NN750625	5/8-18	15/16	35/64
NN700750	3/4-10	*****	3/4-16	1 1/8	41/64
NN700875	7/8-9	*****	7/8-14	1 5/16	3/4
NN701000	1-8	NN751000(1001)	1-14 (-12)	1 1/2	55/64
*****	1 1/8-7	NN751125	1 1/8-12	1 11/16	31/32
NN701250	1 1/4-7	NN751250	1 1/4-12	1 7/8	1 1/16
NN701500	1 1/2-6	*****	1 1/2-12	2 1/4	1 9/32

AUTRES DIMENSIONS DISPONIBLES/OTHER DIMENSIONS ARE AVAILABLE

C-7



SS-304

SS-316

NOTRE CODE	DESCRIPTION	NOTRE CODE	DESCRIPTION	PLAT À PLAT	ÉPAISSEUR	QTÉ/BTE
OUR CODE	DESCRIPTION	OUR CODE	DESCRIPTION	ACROSS FLAT	THICKNESS	QTY/BOX
NS100004	4-40	*****	4-40	1/4	3/32	100
NS100006	6-32	*****	6-32	5/16	7/64	100
NS100008	8-32	NS000008	8-32	11/32	1/8	100
NS100010	10-24	NS000010	10-24	3/8	1/8	100
NS100250	1/4-20	NS000025	1/4-20	7/16	7/32	100
NS100315	5/16-18	NS000031	5/16-18	1/2	17/64	100
NS100375	3/8-16	NS000037	3/8-16	9/16	21/64	100
NS100437	7/16-14	*****	7/16-14	11/16	3/8	50
NS100500	1/2-13	NS000050	1/2-13	3/4	7/16	50
NS100562	9/16-12	*****	9/16-12	7/8	31/64	25
NS100625	5/8-11	NS000062	5/8-11	15/16	35/64	25
NS100750	3/4-10	NS000075	3/4-10	1 1/8	41/64	20
NS100875	7/8-9	*****	7/8-9	1 5/16	3/4	20
NS101000	1-8	NS000100	1-8	1 1/2	55/64	20
NS101125	1 1/8-7	NS000112	1 1/8-7	1 11/16	31/32	15
NS101250	1 1/4-7	NS000125	1 1/4-7	1 7/8	1 1/16	15
NS101500	1 1/2-6	*****	1 1/2-6	2 1/4	1 9/32	10

FILETS FINS DISPONIBLES / NATIONAL FINE THREADS ARE AVAILABLE

PAGE C-27



ÉCROUS PAPILLONS/WING NUTS

PAGE C-23

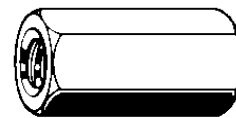

ÉCROUS DE RACCORD/COUPLING NUT

PAGE C-15

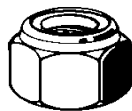

ÉCROUS DE BLOCAGE/LOCK NUTS

PAGE C-12



ÉCROUS À CHAPE/ACORN NUTS

PAGE C-12

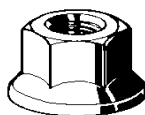

ÉCROUS À COLERETTE/FLANGE NUTS

ÉCROUS HEXAGONAUX
GROS FILETS

LAITON / BRASS

HEX NUTS
NATIONAL COARSE

FILETS FINS
DISPONIBLES



NATIONAL FINE
ARE AVAILABLE

NOTRE CODE	DESCRIPTION	PLAT À PLAT	ÉPAISSEUR	QTÉ/BTE
OUR CODE	DESCRIPTION	ACROSS FLAT	THICKNESS	QTY/BOX
NB000003	3-48	3/16	1/16	100
NB000004	4-40	1/4	3/32	100
NB000005	5-40	5/16	7/64	100
NB000006	6-32	5/16	7/64	100
NB000008	8-32	11/32	1/8	100
NB000010	10-24	3/8	1/8	100
NB100010	10-32	3/8	1/8	100
NB000012	12-24	7/16	5/32	100
NB000250	1/4-20	7/16	7/32	100
NB000315	5/16-18	1/2	17/64	100
NB000375	3/8-16	9/16	21/64	100
NB000437	7/16-14	11/16	3/8	50
NB000500	1/2-13	3/4	7/16	50
NB000562	9/16-12	7/8	31/64	25
NB000625	5/8-11	15/16	35/64	25
NB000750	3/4-10	1 1/8	41/64	20
NB000875	7/8-9	1 5/16	3/4	20
NB001000	1-8	1 1/2	55/64	20
NB001250	1 1/4-7	1 7/8	1 1/16	15

ÉCROUS HEXAGONAUX
GROS FILETS
GRADE 2

H.D.G.

HEX NUTS
NATIONAL COARSE
GRADE 2



NOTRE CODE	DESCRIPTION	PLAT À PLAT	ÉPAISSEUR	QTÉ/BTE
OUR CODE	DESCRIPTION	ACROSS FLAT	THICKNESS	QTY/BOX
NG000250	1/4-20	7/16	7/32	100
NG000315	5/16-18	1/2	17/64	100
NG000375	3/8-16	9/16	21/64	100
NG000500	1/2-13	3/4	7/16	50
NG000625	5/8-11	15/16	35/64	25
NG000750	3/4-10	1 1/8	41/64	20
NG000875	7/8-9	1 5/16	3/4	20
NG001000	1-8	1 1/2	55/64	20
NG001250	1 1/4-7	1 7/8	1 1/16	15
NG001501	1 1/2-6	2 1/4	1 9/32	15



Tel.: (819) 346-2903 / (888) 345-2903 Fax.: (819) 346-3389

Email: distributeur@boulonstrie.com

ÉCROUS HEXAGONAUX
MÉTRIQUE DIN 934
CLASSE 8.8
GROS FILETS

NOIR / BARE
ZINC / PLATED



METRIC DIN 934
HEX NUTS
CLASS 8.8
NATIONAL COARSE

NOIR / BARE

ZINC / PLATED

NOTRE CODE	DESCRIPTION	NOTRE CODE	DESCRIPTION	PLAT À PLAT	ÉPAISSEUR	QTÉ/BTE
OUR CODE	DESCRIPTION	OUR CODE	DESCRIPTION	ACROSS FLAT	THICKNESS	QTY/BOX
*****	M2 X .40	NM200002	M2 X .40	4	1.6	100
*****	M3 X .50	NM200003	M3 X .50	5,5	2.4	100
NM100004	M4 X .70	NM200004	M4 X .70	7	3.2	100
NM100005	M5 X .80	NM200005	M5 X .80	8	4	100
NM100006	M6 X 1.00	NM200006	M6 X 1.00	10	5	100
NM100007	M7 X 1.00	NM200007	M7 X 1.00	11	5.5	100
NM100008	M8 X 1.25	NM200008	M8 X 1.25	13	6.5	100
NM100010	M10 X 1.50	NM200010	M10 X 1.50	17	8	100
NM100012	M12 X 1.75	NM200012	M12 X 1.75	19	10	50
NM100014	M14 X 2.00	NM200014	M14 X 2.00	22	11	50
NM100016	M16 X 2.00	NM200016	M16 X 2.00	24	13	50
NM100018	M18 X 2.50	*****	M18 X 2.50	27	15	20
NM100020	M20 X 2.50	NM200020	M20 X 2.50	30	16	20
NM100022	M22 X 2.50	*****	M22 X 2.50	32	18	20
NM100024	M24 X 3.00	NM200024	M24 X 3.00	36	19	20
*****	M27 X 3.00	*****	M27 X 3.00	41	22	10
NM100030	M30 X 3.50	NM200030	M30 X 3.50	46	24	10
NM100033	M33 X 3.50	*****	M33 X 3.50	50	26	5
NM100036	M36 X 4.00	*****	M36 X 4.00	55	29	5

ÉCROUS HEXAGONAUX
MÉTRIQUE CLASSE 8.8
FILETS FINS



METRIC HEX NUTS
CLASS 8.8
NATIONAL FINE

NOIR / BARE

NOTRE CODE	DESCRIPTION	PLAT À PLAT	ÉPAISSEUR	QTÉ/ BTE	AUTRES DIMENSIONS DISPONIBLES / OTHER DIMENSIONS AVAILABLE.
OUR CODE	DESCRIPTION	ACROSS FLAT	THICKNESS	QTY/BTE	
NM300008	M8 X 1.00	13	6,5	100	AUSSI DISPONIBLE / ALSO AVAILABLE : FILETS FINS PLAQUÉS / NATIONAL FINE PLATED
NM300010	M10 X 1.25 (1.00)	17	8	100	
NM300012	M12 X 1.25	19	10	50	
NM300014	M14 X 1.50	22	11	50	
NM300016	M16 X 1.50	24	13	50	
NM300018	M18 X 1.50	27	15	20	
NM300020	M20 X 1.50	30	16	20	
NM300022	M22 X 1.50	32	18	20	
NM300024	M24 X 2.00	36	19	20	
NM300027	M27 X 2.00	41	22	20	
NM300030	M30 X 2.00	46	24	10	

ÉCROUS HEXAGONAUX
MÉTRIQUE DIN 934
CLASSE 10.9
GROS FILETS

NOIR / BARE
ZINC / PLATED

METRIC DIN 934
HEX NUTS
CLASS 10.9
NATIONAL COARSE



NOIR/BARE

ZINC/PLATED

NOTRE CODE	DESCRIPTION	NOTRE CODE	DESCRIPTION	PLAT À PLAT	ÉPAISSEUR
OUR CODE	DESCRIPTION	OUR CODE	DESCRIPTION	ACROSS FLAT	THICKNESS
*****	M5 X 0.80	NM800005	M5 X 0.80	8	4
NM700006	M6 X 1.00	NM800006	M6 X 1.00	10	5
NM700008	M8 X 1.25	NM800008	M8 X 1.25	13	6.5
NM700010	M10 X 1.50	NM800010	M10 X 1.50	17	8
NM700012	M12 X 1.75	NM800012	M12 X 1.75	19	10
NM700014	M14 X 2.00	NM800014	M14 X 2.00	22	11
NM700016	M16 X 2.00	NM800016	M16 X 2.00	24	13
NM700018	M18 X 2.50	NM800018	M18 X 2.50	27	15
NM700020	M20 X 2.50	NM800020	M20 X 2.50	30	16
NM700024	M24 X 3.00	*****	M24 X 3.00	36	19

FILETS FINS DISPONIBLES / NATIONAL FINE IS AVAILABLE

ÉCROUS HEXAGONAUX
MÉTRIQUE DIN 934
ACIER INOXYDABLE



SS-304 / A-2

HEX NUTS
METRIC DIN 934
STAINLESS STEEL

NOTRE CODE	DESCRIPTION	PLAT À PLAT	ÉPAISSEUR	AUTRES DIMENSIONS DISPONIBLES / OTHER DIMENSIONS AVAILABLE
OUR CODE	DESCRIPTION	ACROSS FLAT	THICKNESS	
NS500003	M3 X 0.50	5.5	2.4	AUSSI DISPONIBLE / ALSO AVAILABLE : SS - 304 :
NS500004	M4 X 0.70	7	3.2	
NS500005	M5 X 0.80	8	4	FILETS FINS / NATIONAL FINE
NS500006	M6 X 1.00	10	5	
NS500008	M8 X 1.25	13	6.5	SS - 316 : GROS FILETS / NATIONAL COARSE FILETS FINS / NATIONAL FINE
NS500010	M10 X 1.50	14.8	9.8	
NS500012	M12 X 1.75	19	10	
NS500014	M14 X 2.00	22	11	
NS500016	M16 X 2.00	24	13	
NS500020	M20 X 2.50	30	16	



Tel.: (819) 346-2903 / (888) 345-2903 Fax.: (819) 346-3389

Email: distributeur@boulonstrie.com

ÉCROUS À CHAPE
PLAQUÉ ZINC



ACORN NUTS
ZINC PLATED

FILETS FINS
DISPONIBLES

NATIONAL FINE
ARE AVAILABLE

NOTRE CODE	DESCRIPTION	PLAT À PLAT	HAUTEUR	QTÉ/BTE
OUR CODE	DESCRIPTION	ACROSS FLAT	HEIGHT	QTY/BOX
*****	4-40	1/4	0.188	100
NA000632	6-32	5/16	0.250	100
NA000832	8-32	5/16	0.250	100
NA001024	10-24	3/8	0.313	100
NA001032	10-32	3/8	0.313	100
NA002500	1/4-20	7/16	0.375	100
NA003150	5/16-18	9/16	0.468	100
NA003750	3/8-16	9/16	0.563	100
NA005000	1/2-13	3/4	0.563	50
NA006250	5/8-11	15/16	0.812	25

ÉCROUS À COLERETTE
AVEC SERRATIONS
PLAQUÉ ZINC

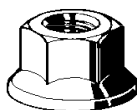

HEX FLANGE NUTS WITH
LOCKING SERRATIONS
ZINC PLATED

FILETS FINS
DISPONIBLES

NATIONAL FINE
ARE AVAILABLE

NOTRE CODE	DESCRIPTION	PLAT À PLAT	EPAISSEUR	FLANGE
OUR CODE	DESCRIPTION	ACROSS FLAT	THICKNESS	COLLET
NF100060	6-32	0.302 - 0.312	0.156 - 0.171	0.406 - 0.422
NF100080	8-32	0.332 - 0.344	0.187 - 0.203	0.452 - 0.469
NF100110	10-24	0.362 - 0.375	0.203 - 0.219	0.480 - 0.500
NF100250	1/4-20	0.428 - 0.437	0.222 - 0.236	0.574 - 0.594
NF100315	5/16-18	0.489 - 0.500	0.268 - 0.283	0.660 - 0.680
NF100375	3/8-16	0.551 - 0.562	0.330 - 0.347	0.728 - 0.750
NF100437	7/16-14	0.675 - 0.687	0.375 - 0.395	0.910 - 0.937
NF100500	1/2-13	0.736 - 0.750	0.437 - 0.458	0.982 - 1.031
NF100625	5/8-11	0.922 - 0.937	0.600 - 0.640	1.280 - 1.330
NF100750	3/4-10	1.088 - 1.125	0.627 - 0.675	1.460 - 1.585



Tel.: (819) 346-2903 / (888) 345-2903 Fax.: (819) 346-3389
Email: distributeur@boulonsestrie.com

C-12

CONTRE-ÉCROUS
HEXAGONAUX

NOIR / BARE

HEX JAM NUTS



N.C

N.F

NOTRE CODE	DESCRIPTION	NOTRE CODE	DESCRIPTION	PLAT À PLAT	ÉPAISSEUR
OUR CODE	DESCRIPTION	OUR CODE	DESCRIPTION	ACROSS FLAT	THICKNESS
JN000250	1/4-20	JN100250	1/4-28	7/16	5/32
JN000315	5/16-18	JN100315	5/16-24	1/2	3/16
JN000375	3/8-16	JN100375	3/8-24	9/16	7/32
JN000437	7/16-14	JN100437	7/16-20	11/16	1/4
JN000500	1/2-13	JN100500	1/2-20	3/4	5/16
JN000562	9/16-12	JN100562	9/16-18	7/8	5/16
JN000625	5/8-11	JN100625	5/8-18	15/16	3/8
JN000750	3/4-10	JN100750	3/4-16	1 1/8	27/64
JN000875	7/8-9	JN100875	7/8-14	1 5/16	31/64
JN001000	1-8	JN101014 (12)	1-14 (12)	1 1/2	35/64
JN001125	1 1/8-7	JN101125	1 1/8-12	1 11/16	39/64
JN001250	1 1/4-7	JN101250	1 1/4-12	1 7/8	23/32
JN001500	1 1/2-6	JN101500	1 1/2-12	2 1/4	27/32

ZINC / PLATED

CONTRE-ÉCROUS
HEXAGONAUX



HEX JAM NUTS

N.C

N.F

NOTRE CODE	DESCRIPTION	NOTRE CODE	DESCRIPTION	PLAT À PLAT	ÉPAISSEUR
OUR CODE	DESCRIPTION	OUR CODE	DESCRIPTION	ACROSS FLAT	THICKNESS
JN200250	1/4-20	JN300250	1/4-28	7/16	5/32
JN200315	5/16-18	JN300315	5/16-24	1/2	3/16
JN200375	3/8-16	JN300375	3/8-24	9/16	7/32
JN200437	7/16-14	JN300437	7/16-20	11/16	1/4
JN200500	1/2-13	JN300500	1/2-20	3/4	5/16
*****	9/16-12	JN300562	9/16-18	7/8	5/16
JN200625	5/8-11	JN300625	5/8-18	15/16	3/8
JN200750	3/4-10	JN300750	3/4-16	1 1/8	27/64
JN200875	7/8-9	JN300875	7/8-14	1 5/16	31/64
JN201000	1-8	JN301000	1-14	1 1/2	35/64
*****	1 1/8-7	JN301125	1 1/8-12	1 11/16	39/64
*****	1 1/4-7	JN301250	1 1/4-12	1 7/8	23/32
JN201500	1 1/2-6	JN301250	1 1/2-12	2 1/4	27/32

AUTRES DIMENSIONS DISPONIBLES /OTHER DIMENSIONS ARE AVAILABLE



N.C.

N.F.

NOTRE CODE	DESCRIPTION	NOTRE CODE	DESCRIPTION	PLAT À PLAT	ÉPAISSEUR
OUR CODE	DESCRIPTION	OUR CODE	DESCRIPTION	ACROSS FLAT	THICKNESS
JN500025	1/4-20	JN700025	1/4-28	7/16	5/32
JN500031	5/16-18	JN700031	5/16-24	1/2	3/16
JN500037	3/8-16	JN700037	3/8-24	9/16	7/32
JN500050	1/2-13	JN700050	1/2-20	3/4	5/16
JN500062	5/8-11	JN700062	5/8-18	15/16	3/8
JN500075	3/4-10	JN700075	3/4-16	1 1/8	27/64
JN500087	7/8-9	JN700087	7/8-14	1 5/16	31/64
JN500100	1-8	JN700100	1-14	1 1/2	35/64
JN501125	1 1/8-7	*****	1 1/8-12	1 11/16	39/64
JN501250	1 1/4-7	JN701250	1 1/4-12	1 7/8	23/32

AUSSI DISPONIBLE/ALSO AVAILABLE

MATÉRIEL:

SS316
BRASS

MATERIAL:

SS316
BRASS

FILETS MÉTRIQUES:

(A2 & A4)

METRIC THREADS:

(A2 & A4)

GROS FILETS & FINS

NATIONAL COARSE & NATIONAL FINE



Tel.: (819) 346-2903 / (888) 345-2903 Fax.: (819) 346-3389

Email: distributeur@boulonsestrie.com

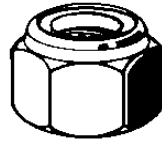

GROS FILETS

NATIONAL COARSE

NOTRE CODE	DESCRIPTION	PLAT À PLAT	ÉPAISSEUR	QTÉ/BTE	QTÉ/VRAC
OUR CODE	DESCRIPTION	ACROSS FLAT	THICKNESS	QTY/BOX	QTY/BULK
LN200004	4-40	-		100	***
LN200006	6-32	5/16	.178	100	3600
LN200008	8-32	11/32	.229	100	3600
LN200010	10-24	3/8	.239	100	3600
LN200012	12-24	-		100	***
LN200250	1/4-20	7/16	.313	100	3600
LN200315	5/16-18	1/2	.344	100	3600
LN200375	3/8-16	9/16	.453	100	2400
LN200437	7/16-14	5/8	.453	50	1200
LN200500	1/2-13	3/4	.594	50	1200
LN200562	9/16-12	7/8	.641	25	600
LN200625	5/8-11	15/16	.750	25	200
LN200750	3/4-10	1 1/16	.875	20	160
LN200875	7/8-9	1 1/4	.984	20	160
LN201000	1-8	1 7/16	1.047	20	120
LN201125	1 1/8-7	1 5/8	1.188	20	90
LN201250	1 1/4-7	1 13/16	1.375	20	60
LN201375	1 3/8-6	2	1.563	20	60
LN201500	1 1/2-6	2 3/16	1.625	10	60
LN201750	1 3/4-5	2 3/4	2.313	***	60
LN201875	1 7/8-6	-	-	***	***
LN202000	2-4 1/2	3 1/8	2.406	***	15
LN202250	2 1/4-4	-	-	***	***
LN202500	2 1/2-4	-	-	***	***

GRADE 5 & GRADE 8

DISPONIBLES SUR DEMANDE / AVAILABLE ON REQUEST



Tel.: (819) 346-2903 / (888) 345-2903 Fax.: (819) 346-3389

Email: distributeur@boulonsestrie.com

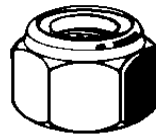

FILETS FINS

NATIONAL FINE

NOTRE CODE	DESCRIPTION	PLAT À PLAT	ÉPAISSEUR	QTÉ/BTE	QTÉ/VRAC
OUR CODE	DESCRIPTION	ACROSS FLAT	THICKNESS	QTY/BOX	QTY/BULK
LN300010	10-32	3/8	.239	100	3600
LN300250	1/4-28	7/16	.313	100	3600
LN300315	5/16-24	1/2	.344	100	3600
LN300375	3/8-24	9/16	.453	100	2400
LN300437	7/16-20	5/8	.453	50	1200
LN300500	1/2-20	3/4	.594	50	1200
LN300562	9/16-18	7/8	.641	25	600
LN300625	5/8-18	15/16	.750	25	200
LN300750	3/4-16	1 1/16	.875	20	160
LN300875	7/8-14	1 1/4	.984	20	160
LN301000	1-14	1 7/16	1.047	20	120
LN301125	1 1/8-12	1 5/8	1.188	25	90
LN301250	1 1/4-12	1 13/16	1.375	20	60
LN301375	1 3/8-12	2	1.563	20	60
LN301500	1 1/2-12	2 3/16	1.625	15	60
LN301750	1 3/4-12	2 3/4	2.313	***	15
LN302000	2-12	3 1/8	2.406	***	15

GRADE 5 & GRADE 8

DISPONIBLES SUR DEMANDE / AVAILABLE ON REQUEST



Tel.: (819) 346-2903 / (888) 345-2903 Fax.: (819) 346-3389

Email: distributeur@boulonsestrie.com

ÉCROUS INDESSERRABLES
ACIER INOXYDABLE
GROS FILETS

SS-304
18-8

NYLON LOCKNUTS
STAINLESS STEEL
NATIONAL COARSE



NOTRE CODE	DESCRIPTION	PLAT À PLAT	ÉPAISSEUR	QTÉ/BOITE
OUR CODE	DESCRIPTION	ACROSS FLAT	THICKNESS	QTY/BOX
LN100063	6-32	0,312	0,172	100
LN100083	8-32	0,344	0,234	100
LN100124	10-24	0,375	0,234	100
LN100132	10-32	0,375	0,234	100
LN100250	1/4-20	0,438	0,313	100
LN100315	5/16-18	0,500	0,344	100
LN100375	3/8-16	0,563	0,453	100
LN100437	7/16-14	0,625	0,453	50
LN100500	1/2-13	0,750	0,594	50
LN100625	5/8-11	0,938	0,750	25
LN100750	3/4-10	1,063	0,875	20

AUTRES DIMENSIONS DISPONIBLES / OTHER DIMENSIONS AVAILABLE

AUSSI DISPONIBLE / ALSO AVAILABLE

SS304 : *FILETS FINS / NATIONAL FINE*

SS316 : *GROS FILETS & FINS / NC & NF THREADS*

ÉCROUS DE NYLON MINCE / HALF LOCKNUTS



Tel.: (819) 346-2903 / (888) 345-2903 Fax.: (819) 346-3389

Email: distributeur@boulonsestrie.com

ÉCROUS INDESSERRABLES
GROS FILETS
DIN 985

MÉTRIQUE/METRIC



NYLON LOCKNUTS
NATIONAL COARSE
DIN 985

CLASSE 8 / CLASS 8

N.C.

FILETS FINS
DISPONIBLES

NOTRE CODE	DESCRIPTION	PLAT À PLAT	ÉPAISSEUR
OUR CODE	DESCRIPTION	ACROSS FLAT	THICKNESS
LN40003	M3 X 0.50	5.5	4
LN40004	M4 X 0.70	7	5
LN40005	M5 X 0.80	8	5
LN40006	M6 X 1.00	10	6
LN40007	M7 X 1.00	11	7.5
LN40008	M8 X 1.25	13	8
LN40010	M10 X 1.50	17	10
LN40012	M12 X 1.75	19	12
LN40014	M14 X 2.00	22	14
LN40016	M16 X 2.00	24	16
LN40018	M18 X 2.50	27	18.5
LN40020	M20 X 2.50	30	20
LN40022	M22 X 2.50	32	22

NATIONAL
FINE IS
AVAILABLE

AUTRES DIMENSIONS DISPONIBLES / OTHER DIMENSIONS ARE AVAILABLE

ÉCROUS INDESSERRABLES
ACIER INOXYDABLE
DIN 985

MÉTRIQUE/METRIC



NYLON LOCKNUTS
STAINLESS STEEL
DIN 985

ACIER INOX.
SS-316 / A-4
DISPONIBLE

NOTRE CODE	DESCRIPTION	PLAT À PLAT	ÉPAISSEUR
OUR CODE	DESCRIPTION	ACROSS FLAT	THICKNESS
LN10003	M3 X 0.50	5.5	4
LN10004	M4 X 0.70	7	5
LN10005	M5 X 0.80	8	5
LN10006	M6 X 1.00	10	6
LN10008	M8 X 1.25	13	8
LN10010	M10 X 1.50	17	10
LN10012	M12 X 1.75	19	12
LN10014	M14 X 2.00	22	14
LN10016	M16 X 2.00	24	16

STAINLESS
STEEL
A-4 / SS316
AVAILABLE



Tel.: (819) 346-2903 / (888) 345-2903 Fax.: (819) 346-3389
Email: distributeur@boulonstrie.com

C-18

ZINC / PLATED

ÉCROUS INDESSERABLES
GROS FILETS
GRADE C



STOVER LOCKNUTS
NATIONAL COARSE
GRADE C

NOTRE CODE	DESCRIPTION	PLAT À PLAT	ÉPAISSEUR	QTÉ/BTE
OUR CODE	DESCRIPTION	ACROSS FLAT	THICKNESS	QTY/BOX
LN700250	1/4-20	7/16	.226	100
LN700315	5/16-18	1/2	.273	100
LN700375	3/8-16	9/16	.337	100
LN700437	7/16-14	11/16	.385	50
LN700500	1/2-13	3/4	.448	50
LN700562	9/16-12	7/8	.496	25
LN700625	5/8-11	15/16	.559	25
LN700750	3/4-10	1 1/8	.665	20
LN700875	7/8-9	1 5/16	.776	20
LN701000	1-8	1 1/2	.887	20
LN701125	1 1/8-7	1 11/16	.999	15
LN701250	1 1/4-7	1 7/8	1.094	15
LN701375	1 3/8-6	2 1/16	1.206	10
LN701500	1 1/2-6	2 1/4	1.317	10

FILETS FINS
GRADE C

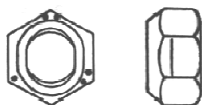

NATIONAL FINE
GRADE C

NOTRE CODE	DESCRIPTION	PLAT À PLAT	ÉPAISSEUR	QTÉ/BTE
OUR CODE	DESCRIPTION	ACROSS FLAT	THICKNESS	QTY/BOX
LN710250	1/4-28	7/16	.226	100
LN710315	5/16-24	1/2	.273	100
LN710375	3/8-24	9/16	.337	100
LN710437	7/16-20	11/16	.385	50
LN710500	1/2-20	3/4	.448	50
LN710562	9/16-18	7/8	.496	25
LN710625	5/8-18	15/16	.559	25
LN710750	3/4-16	1 1/8	.665	20
LN710875	7/8-14	1 5/16	.776	20
LN711000	1-14	1 1/2	.887	20
LN711125	1 1/8-12	1 11/16	.999	15
LN711250	1 1/4-12	1 7/8	1.094	15
LN711375	1 3/8-12	2 1/16	1.206	15
LN711500	1 1/2-12	2 1/4	1.317	15



Tel.: (819) 346-2903 / (888) 345-2903 Fax.: (819) 346-3389

Email: distributeur@boulonsestrie.com

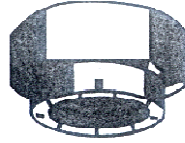

GROS FILETS

NATIONAL COARSE

NOTRE CODE	DESCRIPTION	QTÉ/BTE
OUR CODE	DESCRIPTION	QTY/BOX
LO900250	1/4-20	100
LO900315	5/16-18	100
LO900375	3/8-16	100
LO900437	7/16-14	50
LO900500	1/2-13	50
LO900562	9/16-12	25
LO900675	5/8-11	25
LO900750	3/4-10	20
LO900875	7/8-9	20
LO901000	1-8	20
LO901125	1 1/8-7	15
LO901250	1 1/4-7	15
LO901500	1 1/2-6	10

FILETS FINS

NATIONAL FINE

NOTRE CODE	DESCRIPTION	QTÉ/BTE
OUR CODE	DESCRIPTION	QTY/BOX
LO800250	1/4-28	100
LO800315	5/16-24	100
LO800375	3/8-24	100
LO800437	7/16-20	50
LO800500	1/2-20	50
LO800562	9/16-18	25
LO800625	5/8-18	25
LO800750	3/4-16	20
LO800875	7/8-14	20
LO801000	1-14	20
LO801125	1 1/8-12	15
LO801250	1 1/4-12	15
LO801500	1 1/2-12	10



Tel.: (819) 346-2903 / (888) 345-2903 Fax.: (819) 346-3389

Email: distributeur@boulonsestrie.com

ÉCROUS DE NYLON MINCE
INDESSERABLES
GRADE 2

ZINC / PLATED

HALF NYLON
LOCKNUTS
GRADE 2

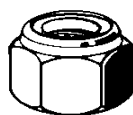

GROS FILETS
&
FILETS FINS

MINCE / THIN

NATIONAL COARSE
&
NATIONAL FINE

NOTRE CODE	DESCRIPTION	PLAT À PLAT	ÉPAISSEUR	QTÉ/BTE
OUR CODE	DESCRIPTION	ACROSS FLAT	THICKNESS	QTY/BOX
LN800010	10-24	.375	.172	100
LN800011	10-32	.375	.172	100
LN800012	12-24	.437	.203	100
LN800250	1/4-20	.438	.203	100
LN800251	1/4-28	.438	.203	100
LN800315	5/16-18	.500	.344	100
LN800316	5/16-24	.500	.344	100
LN800375	3/8-16	.562	.266	100
LN800376	3/8-24	.562	.266	100
LN800437	7/16-14	.625	.313	50
LN800438	7/16-20	.625	.313	50
LN800500	1/2-13	.750	.313	50
LN800501	1/2-20	.750	.313	50
LN800625	5/8-11	.938	.391	25
LN800626	5/8-18	.938	.391	25
LN800750	3/4-10	1.062	.406	20
LN800751	3/4-16	1.062	.406	20
LN800875	7/8-9	1.250	.469	20
LN800876	7/8-14	1.250	.469	20
LN801000	1-8	1.438	.547	20
LN801001	1-14	1.438	.547	20
*****	1 1/4-7	1.812	.734	15
LN801251	1 1/4-12	1.812	.734	15
LN801375	1 3/8-6	2.000	.790	15
*****	1 3/8-12	2.000	.790	15
LN801500	1 1/2-6	2.188	.797	10
LN801501	1 1/2-12	2.188	.797	10



Tel.: (819) 346-2903 / (888) 345-2903 Fax.: (819) 346-3389

Email: distributeur@boulonsestrie.com

C-21

PLAQUÉ ZINC
EST DISPONIBLE

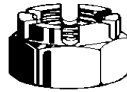

ZINC PLATED
IS AVAILABLE

NC

NF

NOTRE CODE	DESCRIPTION	NOTRE CODE	DESCRIPTION	QTÉ/BTE
OUR CODE	DESCRIPTION	OUR CODE	DESCRIPTION	QTY/BOX
*****	1/4-20	NC100250	1/4-28	100
NC200315	5/16-18	NC100315	5/16-24	100
*****	3/8-16	*****	3/8-24	100
NC200437	7/16-14	NC100437	7/16-20	50
NC200500	1/2-13	NC100500	1/2-20	50
*****	9/16-12	NC100562	9/16-18	50
NC200625	5/8-11	NC100625	5/8-18	25
NC200750	3/4-10	NC100750	3/4-16	20
NC200875	7/8-9	NC100875	7/8-14	20
NC201000	1-8	NC101000	1-14	20
NC201125	1 1/8-7	NC101125	1 1/8-12	15
NC201250	1 1/4-7	NC101250	1 1/4-12	15
NC201375	1 3/8-6	*****	1 3/8-12	15
NC201500	1 1/2-6	NC101500	1 1/2-12	10
*****	1 3/4-5	NC101750	1 3/4-12	10
*****	1 7/8-5	NC101875	1 7/8-12	10

DEMI NOIX CHÂTEAU DISPONIBLES / HALF CASTEL NUTS ARE AVAILABLE

ÉCROUS TRÈS HAUTS



DEEP NUTS

NOTRE CODE	DESCRIPTION	PLAT À PLAT	ÉPAISSEUR	QTÉ/BTE
OUR CODE	DESCRIPTION	ACROSS FLAT	THICKNESS	QTY/BOX
*****	1/4-28	7/16	3/8	100
*****	5/16-24	1/2	29/64	100
ND000375	3/8-24	9/16	17/32	100
*****	7/16-18	11/16	3/4	50
ND000500	1/2-20	3/4	11/16	50
ND000562	9/16-18	7/8	49/64	25
ND000625	5/8-18	1	27/32	25
ND000750	3/4-16	1 1/8	1	20
ND000875	7/8-14	1 5/16	1 5/32	20
ND001000	1-14	1 7/16	1 5/16	15
ND001125	1 1/8-12	1 11/16	1 1/2	15
ND001250	1 1/4-12	1 7/8	1 11/16	15



Tel.: (819) 346-2903 / (888) 345-2903 Fax.: (819) 346-3389

Email: distributeur@boulonstrie.com

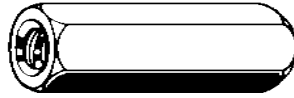

NOTRE CODE	DESCRIPTION	CLÉ (PLAT À PLAT)	LONGUEUR	QTÉ/BTE
OUR CODE	DESCRIPTION	ACROSS FLAT	LENGTH	QTY/BOX
CN000010	10-24	5/16	3/4	100
CN000025	1/4-20	7/16	7/8	100
CN000031	5/16-18	5/16	1 3/4	100
CN000036	3/8-16	9/16	1 1/8	100
CN000037	3/8-16	1/2	1 3/4	100
CN000043	7/16-14	5/8	1 3/4	50
CN000050	1/2-13	3/4	1 3/4	50
CN000061	5/8-11	13/16	2 1/8	25
CN000062	5/8-11	15/16	2 1/8	25
CN000075	3/4-10	1 1/8	2 1/4	20
CN000087	7/8-9	1 1/4	2 1/2	20
CN000100	1-8	1 1/4	2 1/2	20

AUSSI DISPONIBLE / ALSO AVAILABLE

MATÉRIEL: NOIR, SS304 & SS316
MATERIAL: BARE, SS304 & SS316

FILETS FINS
NATIONAL FINE THREADS

FILETS ACME & MÉTRIQUE
ACME & METRIC THREADS

FILETS À GAUCHE
LEFT-HAND THREADS



Tel.: (819) 346-2903 / (888) 345-2903 Fax.: (819) 346-3389
Email: distributeur@boulonsestrie.com

ÉCROUS HEXAGONAUX
"ACME"
ACIER C-1018

NOIR / BARE

"ACME" HEXAGON NUTS
C-1018 STEEL



NOTRE CODE	DESCRIPTION	PLAT À PLAT	ÉPAISSEUR	QTÉ/BTE
OUR CODE	DESCRIPTION	ACROSS FLAT	THICKNESS	QTY/BOX
*****	3/8-12	11/16	3/8	10
NA700500	1/2-10	3/4	7/16	10
NA700625	5/8-8	15/16	35/64	10
NA700750	3/4-6	1 1/8	41/64	10
NA700875	7/8-6	1 5/16	3/4	5
NA701000	1-5	1 1/2	55/64	5
NA701125	1 1/8-5	1 13/16	1 7/64	5
NA701250	1 1/4-5	1 7/8	1 1/16	5
NA701500	1 1/2-4	2 3/16	1 9/32	5
NA702000	2-4	3	1 3/4	1

NOIR / BARE

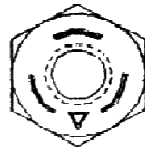

ÉCROUS DE STRUCTURE
A563-C

HEX STRUCTURAL NUTS
A563-C

NOTRE CODE A563-C	DESCRIPTION	PLAT À PLAT	ÉPAISSEUR	QTÉ/BTE
OUR CODE A563-C	DESCRIPTION	ACROSS FLAT	THICKNESS	QTY/BOX
*****	1/2-13	0.850 À 0.875	0.464 À 0.504	50
NS400625	5/8-11	1.031 À 1.062	0.587 À 0.631	25
NS400750	3/4-10	1.212 À 1.250	0.710 À 0.758	20
NS400875	7/8-9	1.394 À 1.438	0.833 À 0.885	20
NS401000	1-8	1.575 À 1.625	0.956 À 1.012	15
NS401125	1 1/8-7	1.756 À 1.812	1.079 À 1.139	15
NS401250	1 1/4-7	1.938 À 2.000	1.187 À 1.251	15
NS401500	1 1/2-6	2.300 À 2.375	1.433 À 1.505	10



Tel.: (819) 346-2903 / (888) 345-2903 Fax.: (819) 346-3389
Email: distributeur@boulonstrie.com

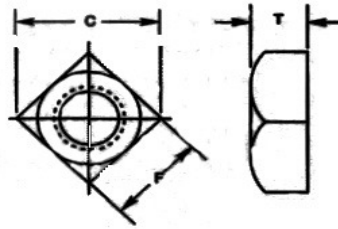

NOIR / BARE

NOTRE CODE	DIMENSION	(F)	(C)	(T)
OUR CODE	SIZE	ACROSS FLAT	ACROSS CORNERS	THICKNESS
NS700250	1/4-20	7/16	39/64	7/32
NS700315	5/16-18	9/16	25/32	17/64
NS700375	3/8-16	5/8	55/64	21/64
NS700437	7/16-14	3/4	1 1/32	3/8
NS700500	1/2-13	13/16	1 1/8	7/16
NS700625	5/8-11	1	1 3/8	35/64
NS700750	3/4-10	1 1/8	1 17/32	21/32
NS700875	7/8-9	1 5/16	1 51/64	49/64
NS701000	1"-8	1 1/2	2 1/16	7/8
NS701125	1 1/8-7	1 11/16	2 5/16	1

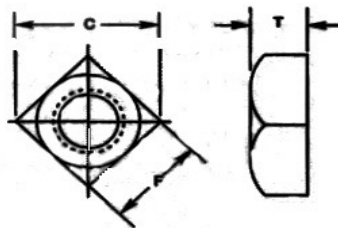

ZINC / PLATED

NOTRE CODE	DIMENSION	(F)	(C)	(T)
OUR CODE	SIZE	ACROSS FLAT	ACROSS CORNERS	THICKNESS
NS800005	5-40	*****	*****	*****
NS800006	6-32 (1/8)	*****	*****	*****
NS800008	8-32	*****	*****	*****
NS800010	10-24	*****	*****	*****
NS800011	10-32	*****	*****	*****
NS800250	1/4-20	7/16	39/64	7/32
NS800315	5/16-18	9/16	25/32	17/64
NS800375	3/8-16	5/8	55/64	21/64
NS800625	5/8-11	1	1 3/8	35/64
NS800750	3/4-10	1 1/8	1 17/32	21/32

ÉCROUS HEXAGONAUX
LARGES
A194 - 2H

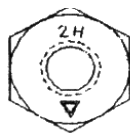

HEAVY HEX
NUTS
A194 - 2H

NOIR					BARE
NOTRE CODE A194-2H	DESCRIPTION	PLAT À PLAT	ÉPAISSEUR	QTÉ/BTE	
OUR CODE A194-2H	DESCRIPTION	ACROSS FLAT	THICKNESS	QTY/BOX	
NH020500	1/2-13	7/8	31/64	50	DISPONIBLE / AVAILABLE ACIER INOXYDABLE / STAINLESS STEEL & H.D.G.
NH020625	5/8-11	1 1/16	39/64	25	
NH020750	3/4-10	1 1/4	47/64	20	
NH020875	7/8-9	1 7/16	55/64	20	
NH021000	1-8	1 5/8	63/64	15	
NH021125	1 1/8-7	1 13/16	1 7/64	15	
NH021250	1 1/4-7	2	1 7/32	15	
NH021500	1 1/2-6	2 3/8	1 15/32	10	
NH021750	1 3/4-5	2 3/4	1 23/32	10	
NH022000	2-4 1/2	3 1/8	1 31/32	5	
NH022250	2 1/4-4 1/2	3 1/2	2 13/64	5	

ÉCROUS HEXAGONAUX
LARGES
GRADE 2



HEAVY HEX
NUTS
GRADE 2

NOIR & ZINC / BARE & PLATED

NOTRE CODE NOIR	NOTRE CODE ZINC	DESCRIPTION	PLAT À PLAT	ÉPAISSEUR	
OUR CODE BARE	OUR CODE PLATED	DESCRIPTION	ACROSS FLAT	THICKNESS	
NH000250	NH100250	1/4-20	1/2	15/64	DISPONIBLE / AVAILABLE ACIER INOXYDABLE / STAINLESS STEEL
NH000315	NH100315	5/16-18	9/16	19/64	
NH000375	NH100375	3/8-16	11/16	23/64	
NH000437	NH100437	7/16-14	3/4	27/64	
NH000500	NH100500	1/2-13	7/8	31/64	
NH000562	NH100562	9/16-12	15/16	35/64	
NH000625	NH100625	5/8-11	1 1/16	39/64	
NH000750	NH100750	3/4-10	1 1/4	47/64	
NH000875	NH100875	7/8-9	1 7/16	55/64	
NH001000	NH101000	1-8	1 5/8	63/64	
NH001125	*****	1 1/8-7	1 13/16	1 7/64	
NH001250	NH101250	1 1/4-7	2	1 7/32	
NH001375	*****	1 3/8-6	2 3/16	1 11/32	
NH001500	NH101500	1 1/2-6	2 3/8	1 15/32	
NH001750	*****	1 3/4-5	2 3/4	1 23/32	
NH001875	*****	1 7/8-5	2 15/16	1 27/32	

AUTRES DIMENSIONS DISPONIBLES/OTHER DIMENSIONS ARE AVAILABLE



NOTRE CODE	DESCRIPTION	LARGEUR AILES	QTÉ/BTE	
OUR CODE	DESCRIPTION	WING SPREAD	QTY/BOX	
NW100063	6-32	23/32	100	AUSSI DISPONIBLE / ALSO AVAILABLE: SS 304 & SS 316
NW100083	8-32	7/8	100	
NW100102	10-24	7/8	100	
NW100103	10-32	7/8	100	
NW100250	1/4-20	1 1/16	100	
NW100315	5/16-18	1 3/16	100	
NW100375	3/8-16	1 13/32	100	LAITON / BRASS
NW100437	7/16-14	1 7/8	50	MÉTRIQUE/ METRIC
NW100500	1/2-13	1 7/8	50	
NW100625	5/8-11	2 9/16	25	
NW100750	3/4-10	2 5/8	20	



NOTRE CODE	DESCRIPTION	DIA. BASE	DIA. BARIL	HAUTEUR BARIL
OUR CODE	DESCRIPTION	BASE DIA.	BARREL DIA.	BARIL HEIGHT
NT000008	8-32	0.600	0.199 - 0.208	0.250
NT000010	10-24	0.750	0.227 - 0.232	0.313
NT000011	10-32	0.750	0.227 - 0.232	0.313
NT000250	1/4	0.750	0.306 - 0.311	0.313
NT000315	5/16	0.875	0.373 - 0.378	0.375
NT000375	3/8	1.000	0.466 - 0.471	0.438

ZINC DISPONIBLE SUR DEMANDE / PLATED AVAILABLE ON REQUEST



Tel.: (819) 346-2903 / (888) 345-2903 Fax.: (819) 346-3389

Email: distributeur@boulonstrie.com



NOTRE CODE	DIA. NOMINAL	DIAM. FILET	CHARGE ADM.
OUR CODE	NOM. DIAMETER	THREAD DIA.	MAX LOAD
CH140525	1/4"	1/4"	520 LBS
CH140531	5/16"	3/8"	1250 LBS
CH140537	3/8"	1/2"	2250 LBS
CH140550	1/2"	5/8"	3600 LBS
CH140562	5/8"	3/4"	5200 LBS
CH140575	3/4"	7/8"	7200 LBS
CH140587	7/8"	1"	10000 LBS
CH141510	1"	1 1/4"	15000 LBS

*******ATTENTION*******

LA CHARGE ADMISSIBLE S'APPLIQUE À UNE TRACTION DROITE SEULEMENT.
NE JAMAIS INTRODUIRE UN CROCHET DANS L'OEIL DU BOULON,
TOUJOURS UTILISER UNE MANILLE!

*******BEWARE*******







THE ADMISSIBLE WEIGHT IS APPLICABLE ON STRAIGHT PULLING ONLY.
NEVER INTRODUCE OR INSERT A HOOK INTO THE EYE BOLT,
ALWAYS USE A SHACKLE!

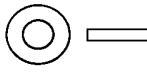
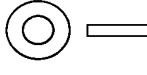

SECTION D

RONDELLES / WASHERS

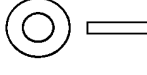
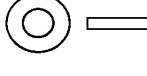
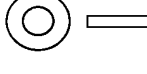
INFORMATION TECHNIQUE.....DÉBUT DE LA SECTION
 TECHNICAL INFORMATION.....BEGINNING OF THIS SECTION

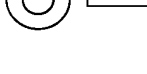
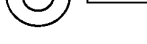
	DESCRIPTION	SECTION-PAGE
	RONDELLES PLATES USS, NOIR & ZINC. FLAT WASHERS USS, BARE & PLATED.	D-1
	RONDELLES PLATES, SS-304 & SS-316. FLAT WASHERS, SS-304 & SS-316.	D-2
	RONDELLES S.A.E, NOIR & ZINC. S.A.E WASHERS, BARE & PLATED.	D-3
	RONDELLES S.A.E, SS-304. S.A.E WASHERS, SS-304.	SUR DEMANDE ON REQUEST
	RONDELLES PLATES LARGES, ZINC. FLAT WASHERS FENDER, PLATED.	D-3
	RONDELLES PLATES LARGES, SS-304. FLAT WASHERS FENDER, SS-304.	SUR DEMANDE ON REQUEST
	RONDELLES PLATES MÉTRIQUE , DIN 125A , NOIR & ZINC. FLAT WASHERS DIN 125A, METRIC , BARE & PLATED.	D-4
	RONDELLES PLATES MÉTRIQUE DIN 125A , SS-304. FLAT WASHERS DIN 125A, METRIC, SS-304.	D-4
	RONDELLES PLATES, MÉTRIQUE DIN 125A , SS-316. FLAT WASHERS, DIN 125A METRIC , SS-316.	SUR DEMANDE ON REQUEST
	RONDELLES PLATES, LAITON. FLAT WASHERS, BRASS.	D-5
	RONDELLES PLATES, H.D.G. FLAT WASHERS, H.D.G.	D-6
	RONDELLES PLATE, L-9. FLAT WASHERS, L-9.	D-6











SECTION D

RONDELLES / WASHERS

DESCRIPTION	SECTION - PAGE
 <p>RONDELLES DE STRUCTURE, <i>ASTM F436</i>, NOIR. HARDENED STEEL WASHERS, <i>ASTM F436</i>, PLAIN.</p>	D-7
 <p>RONDELLES DE STRUCTURE, <i>ASTM F436</i>, ZINC ou JAUNE. HARDENED STEEL WASHERS, <i>ASTM F436</i>, PLATED or YELLOW.</p>	SUR DEMANDE ON REQUEST
 <p>RONDELLES DE STRUCTURE, <i>ASTM F436</i>, H.D.G. HARDENED STEEL WASHERS, <i>ASTM F436</i>, H.D.G.</p>	SUR DEMANDE ON REQUEST
 <p>RONDELLES BOMBÉES AVEC CAOUTCHOUC, ZINC. BONDED WASHERS, PLATED.</p>	D-8
 <p>RONDELLES BOMBÉES AVEC CAOUTCHOUC, SS-304. BONDED WASHERS, SS-304.</p>	SUR DEMANDE ON REQUEST
 <p>RONDELLES D'EMPLACEMENT. BEVEL WASHERS.</p>	D-8
 <p>RONDELLES PLATES EN NYLON. NYLON FLAT WASHERS.</p>	SUR DEMANDE ON REQUEST
 <p>RONDELLES DE FINITION. FINISHING WASHERS.</p>	SUR DEMANDE ON REQUEST
 <p>RONDELLES DE BLOCAGE, NOIR & ZINC. LOCK WASHERS, BARE & PLATED.</p>	D-9
 <p>RONDELLES DE BLOCAGE À COLLET ÉLEVÉ, ZINC. LOCK WASHERS HIGH COLLAR, PLATED.</p>	D-9
 <p>RONDELLES DE BLOCAGE, SS-304. LOCK WASHERS, SS-304.</p>	D-10
 <p>RONDELLES DE BLOCAGE, SS-316. LOCK WASHERS, SS-316.</p>	SUR DEMANDE ON REQUEST
 <p>RONDELLES DE BLOCAGE, ACIER ALLOY. LOCK WASHERS, ALLOY STEEL.</p>	D-10

SECTION D

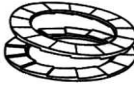
RONDELLES / WASHERS

	DESCRIPTION	SECTION - PAGE
	RONDELLES DE BLOCAGE, H.D.G. LOCK WASHERS, H.D.G.	D-11
	RONDELLES DE BLOCAGE SILICONE BRONZE. LOCK WASHERS SILICON BRONZE.	D-11
	RONDELLES DE BLOCAGE, MÉTRIQUE <i>DIN 127B</i>, NOIR & ZINC. LOCK WASHERS, DIN 127B, METRIC, BARE & PLATED.	D-12
	RONDELLES DE BLOCAGE, MÉTRIQUE <i>DIN 127B</i>, SS-304 & SS-316. LOCK WASHERS, DIN 127B, METRIC, SS-304 & SS-316.	D-12
	RONDELLES DE BLOCAGE DENTÉES (INTÉRIEUR), ZINC. TOOTH LOCK WASHERS (INTERNAL), PLATED.	D-13
	RONDELLES DE BLOCAGE DENTÉES (EXTÉRIEUR), ZINC. TOOTH LOCK WASHERS (EXTERNAL), PLATED.	D-13
	RONDELLES DE BLOCAGE DENTÉES (EXTÉRIEUR 82 DEGRES), ZINC. TOOTH LOCK WASHERS (EXTERNAL 82 DEGRES), COUNTERSUNK, PLATED.	D-13
	RONDELLES DE BLOCAGE DENTÉES (EXTÉRIEUR-INTÉRIEUR), ZINC. TOOTH LOCK WASHERS (EXTERNAL-INTERNAL), PLATED.	D-13
	RONDELLES DE BLOCAGE NORD-LOCK. LOCK WASHERS NORD-LOCK.	SUR DEMANDE ON REQUEST
	RONDELLES DE BLOCAGE "Belleville". LOCK WASHERS DISC SPRINGS.	SUR DEMANDE ON REQUEST

INFORMATIONS TECHNIQUES / TECHNICAL INFORMATION

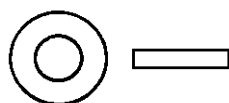

**RONDELLES PLATES USS
USS FLAT WASHERS**

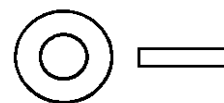

DIMENSION VIS / BOULONS SCREW / BOLT SIZE	DIAMÈTRE INTÉRIEUR HOLE DIAMETER	DIAMÈTRE EXTÉRIEUR OUTSIDE DIAMETER	ÉPAISSEUR / THICKNESS		QTÉ PAR 50 LBS
			GAUGE GAGE	POUCES INCHES	APPROX IN 50 LBS (PCES)
1/8	3/16	7/16	18	3/64	27700
3/16	1/4	9/16	18	3/64	14700
1/4	5/16	3/4	16	1/16	8100
5/16	3/8	7/8	14	5/64	4800
3/8	7/16	1	14	5/64	3730
7/16	1/2	1-1/4	13	3/32	1900
1/2	9/16	1-3/8	12	7/64	1370
9/16	5/8	1-1/2	12	7/64	1150
5/8	11/16	1-3/4	10	9/64	645
5/8 L	3/4	1-3/4	10	9/64	670
3/4	13/16	2	10	9/64	500
3/4 L	7/8	2	9	5/32	465
7/8	15/16	2-1/4	9	5/32	360
7/8 L	1	2-1/4	9	5/32	370
1	1-1/16	2-1/2	9	5/32	290
1 L	1-1/8	2-1/2	9	5/32	300
1-1/8	1-3/16	2-3/4	9	5/32	245
1-1/8 L	1-1/4	2-3/4	9	5/32	250
1-1/4	1-5/16	2-3/4	9	5/32	260
1-1/4 L	1-3/8	3	9	5/32	210
1-3/8	1-1/2	3-1/4	9	5/32	180
1-1/2	1-9/16	3-1/4	8	11/64	170
1-1/2 L	1-5/8	3-1/2	8	11/64	140
1-5/8	1-3/4	3-3/4	8	11/64	125
1-3/4	1-13/16	3-3/4	7	3/16	115
1-3/4 L	1-7/8	4	7	3/16	100
2	2-1/16	4-1/4	7	3/16	90
2 L	2-1/8	4-1/2	7	3/16	80



Tel.: (819) 346-2903 / (888) 345-2903 Fax.: (819) 346-3389

Email: distributeur@boulonstrie.com

INFO TECHNIQUE D (T-1)

INFORMATIONS TECHNIQUES / TECHNICAL INFORMATION

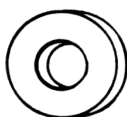

**RONDELLES S.A.E
S.A.E WASHERS**

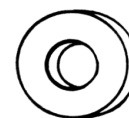

DIMENSION VIS / BOULONS	DIAMÈTRE INTÉRIEUR	DIAMÈTRE EXTÉRIEUR	ÉPAISSEUR / THICKNESS		QTÉ PAR 50 LBS
			GAUGE	POUCES	APPROX IN
SCREW / BOLT SIZE	HOLE DIAMETER	OUTSIDE DIAMETER	GAGE	INCHES	50 LBS (PCES)
NO.2	3/32	1/4	22	1/32	125000
NO.4	1/8	5/16	22	1/32	82500
NO.6(1/8)	5/32	3/8	18	3/64	40000
NO.8	3/16	7/16	18	3/64	27500
NO.10(3/16)	7/32	1/2	16	1/16	18500
1/4	9/32	5/8	16	1/16	12200
5/16	11/32	11/16	16	1/16	10600
3/8	13/32	13/16	16	1/16	7570
7/16	15/32	59/64	16	1/16	5680
1/2	17/32	1-1/16	13	3/32	2950
9/16	19/32	1-3/16	13	3/32	2370
5/8	21/32	1-5/16	13	3/32	1940
3/4	13/16	1-1/2	11	1/8	1180
7/8	15/16	1-3/4	11	1/8	860
1	1-1/16	2	11	1/8	655

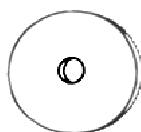

**RONDELLES PLATES LARGES
FLAT WASHERS FENDER**

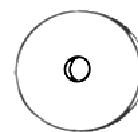

DIMENSION VIS / BOULONS	DIAMÈTRE INTÉRIEUR	DIAMÈTRE EXTÉRIEUR	ÉPAISSEUR / THICKNESS		QTÉ PAR 50 LBS
			GAUGE	POUCES	APPROX IN
SCREW / BOLT SIZE	HOLE DIAMETER	OUTSIDE DIAMETER	GAGE	INCHES	50 LBS (PCES)
3/16	13/64	3/4	18	3/64	9260
1/4	9/32	1-1/4	16	1/16	2500
5/16	11/2	1	16	1/16	4160
5/16	11/32	1-1/4	16	1/17	2630
5/16	11/32	1-1/2	16	1/18	1800
3/8	13/32	1-1/2	16	1/19	1750
1/2	17/32	2	16	1/20	980



Tel.: (819) 346-2903 / (888) 345-2903 Fax.: (819) 346-3389

Email: distributeur@boulonstrie.com

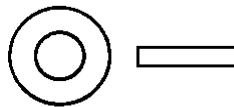

NOTRE CODE NOIR	DESCRIPTION	NOTRE CODE ZINC	DESCRIPTION	QTÉ/BTE
OUR CODE BARE	DESCRIPTION	OUR CODE PLATED	DESCRIPTION	QTY/BOX
*****	#4 BS (1/8 HS)	SNW277	#4 BS (1/8 HS)	100
WF100125	1/8 BS (3/16HS)	WF200125	1/8 BS (3/16 HS)	100
WF100187	3/16 BS (1/4 HS)	WF200187	3/16 BS (1/4 HS)	100
WF100250	1/4 BS (5/16 HS)	WF200250	1/4 BS (5/16 HS)	100
WF100315	5/16 BS (3/8HS)	WF200315	5/16 BS (3/8 HS)	100
WF100375	3/8 BS (7/16 HS)	WF200375	3/8 BS (7/16 HS)	100
WF100437	7/16 BS (1/2 HS)	WF200437	7/16 BS (1/2 HS)	50
WF100500	1/2 BS (9/16 HS)	WF200500	1/2 BS (9/16 HS)	50
WF100562	9/16 BS (5/8 HS)	WF200562	9/16 BS (5/8 HS)	25
WF100625	5/8 BS (11/16 HS)	WF200625	5/8 BS(11/16 HS)	25
*****	5/8 L BS (3/4 HS)	WF200626	5/8 L BS (3/4 HS)	20
WF100750	3/4 BS (13/16 HS)	WF200750	3/4 BS (13/16 HS)	20
*****	3/4L BS (7/8 HS)	*****	3/4 L BS (7/8 HS)	20
WF100875	7/8 BS (15/16 HS)	WF200875	7/8 BS (15/16 HS)	20
*****	7/8 L BS (1 HS)	WF200876	7/8 L BS (1 HS)	20
WF101000	1 BS (1 1/16 HS)	WF201000	1 BS (1 1/16 HS)	20
*****	1 L BS (1 1/8 HS)	*****	1 L BS (1 1/8 HS)	20
*****	1 1/8 BS (1 3/16 HS)	*****	1 1/8 BS (1 3/16 HS)	20
WF101125	1 1/8 L BS (1 1/4 HS)	WF201125	1 1/8 L BS (1 1/4 HS)	20
*****	1 1/4 BS (1 5/16 HS)	*****	1 1/4 BS (1 5/16 HS)	20
WF101250	1 1/4 L BS (1 3/8 HS)	WF201250	1 1/4 L BS (1 3/8 HS)	20
WF101375	1 3/8 BS (1 1/2 HS)	WF201375	1 3/8 BS (1 1/2 HS)	20
*****	1 1/2 BS (1 9/16 HS)	*****	1 1/2 BS (1 9/16 HS)	20
WF101500	1 1/2 L BS (1 5/8 HS)	WF201500	1 1/2 L BS (1 5/8 HS)	20
WF101625	1 5/8 BS (1 3/4 HS)	WF201625	1 5/8 BS (1 3/4 HS)	20
*****	1 3/4 BS (1 13/16 HS)	*****	1 3/4 BS (1 13/16 HS)	20
WF101750	1 3/4 L BS (1 7/8 HS)	WF201750	1 3/4 L BS (1 7/8 HS)	20
*****	2 BS (2 1/16 HS)	*****	2 BS (2 1/16 HS)	10
WF102000	2 L BS (2 1/8 HS)	WF202000	2 L BS (2 1/8 HS)	10

AUTRES DIMENSIONS DISPONIBLES / OTHER DIMENSIONS ARE AVAILABLE



Tel.: (819) 346-2903 / (888) 345-2903 Fax.: (819) 346-3389

Email: distributeur@boulonsestrie.com

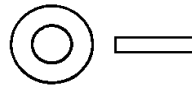

NOTRE CODE	DESCRIPTION	QTÉ/BTE
OUR CODE	DESCRIPTION	QTY/BOX
WS100004	#4 BS (.125 I.D) .312 O.D	100
WS100006	#6 BS (.149 I.D) 3/8 O.D	100
WS100008	#8 BS (.174 I.D) 3/8 O.D	100
WS100010	#10 BS (.203 I.D) 7/16 O.D	100
WS100250	1/4 BS (.281 I.D) 5/8 O.D	100
WS100315	5/16 BS (.343 I.D) 3/4 O.D	100
WS100375	3/8 BS (.406 I.D) 7/8 O.D	100
WS100437	7/16 BS (.500 I.D) 1-1/8 O.D	50
WS100500	1/2 BS (.531 I.D) 1-1/4 O.D	50
WS100562	9/16 BS (.625 I.D) 1-3/8 O.D	25
WS100625	5/8 BS (.687 I.D) 1-1/2 O.D	25
WS100750	3/4 BS (.812 I.D) 1-7/8 O.D	20
WS100875	7/8 BS (.937 I.D) 2 O.D	20
WS101000	1 BS (1.062 I.D) 2 O.D	20
WS101250	1 1/4 BS (1.312 I.D) 2-3/4 O.D	20
WS101500	1 1/2 BS (1.562 I.D) 3-1/4 O.D	15

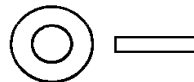

NOTRE CODE	DESCRIPTION	QTÉ/BTE
OUR CODE	DESCRIPTION	QTY/BOX
WS116187	3/16 BS (.203 I.D) 7/16 O.D	100
WS116250	1/4 BS (.281 I.D) 5/8 O.D	100
WS116315	5/16 BS (.343 I.D) 3/4 O.D	100
WS116375	3/8 BS (.406 I.D) 7/8 O.D	100
WS116437	7/16 BS (.500 I.D) 1 -1/8 O.D	50
WS116500	1/2 BS (.531 I.D) 1-1/4 O.D	50
WS116562	9/16 BS (.625 I.D) 1-3/8 O.D	50
WS116625	5/8 BS (.687 I.D) 1-1/2 O.D	25
WS116750	3/4 BS (.812 I.D) 1-7/8 O.D	20
WS116875	7/8 BS (.937 I.D) 2 O.D	20
WS116900	1 BS (1.062 I.D) 2 O.D	15
WS116912	1 1/8 BS (1.187 I.D) 2 1/2 O.D	15
WS116925	1 1/4 BS (1.312 I.D) 2-3/4 O.D	15
WS116950	1 1/2 BS (1.562 I.D) 3-1/4 O.D	15





NOIR / BARE

ZINC / PLATED

NOTRE CODE	DESCRIPTION	NOTRE CODE	DESCRIPTION	QTÉ/BTE
OUR CODE	DESCRIPTION	OUR CODE	DESCRIPTION	QTY/BOX
*****	#4 BS (1/8 I.D)	*****	#4 BS (1/8 I.D)	100
WF500156	#6 (1/8) BS (5/32 I.D)	WF600125	#6 (1/8) BS (5/32 I.D)	100
WF500165	#8 BS (3/16 I.D)	*****	#8 BS (3/16 I.D)	100
WF500187	#10 (3/16) BS (7/32 I.D)	WF600187	#10 (3/16) BS (7/32 I.D)	100
WF500250	1/4 BS (9/32 I.D)	WF600250	1/4 BS (9/32 I.D)	100
WF500315	5/16 BS (11/32 I.D)	WF600315	5/16 BS (11/32 I.D)	100
WF500375	3/8 BS (13/32 I.D)	WF600375	3/8 BS (13/32 I.D)	100
WF500437	7/16 BS (15/32 I.D)	WF600437	7/16 BS (15/32 I.D)	50
WF500500	1/2 BS (17/32 I.D)	WF600500	1/2 BS (17/32 I.D)	50
WF500562	9/16 BS (19/32 I.D)	WF600562	9/16 BS (19/32 I.D)	25
WF500625	5/8 BS (21/32 I.D)	WF600625	5/8 BS (21/32 I.D)	25
WF500750	3/4 BS (13/16 I.D)	WF600750	3/4 BS (13/16 I.D)	25
WF500875	7/8 BS (15/16 I.D)	WF600875	7/8 BS (15/16 I.D)	20
WF501000	1 BS (1-1/16 I.D)	*****	1 BS (1-1/16 I.D)	20

RONDELLES PLATES
EXTÉRIEUR PLUS LARGE

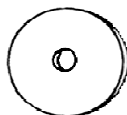

ZINC / PLATED

FLAT WASHERS FENDER

NOTRE CODE	DESCRIPTION	QTÉ/BTE
OUR CODE	DESCRIPTION	QTY/BOX
WF300187	3/16 BS (13/64 HS)	100
WF300250	1/4 BS (9/32 HS)	100
WF300313	5/16 BS (11/32 HS) X 1	100
WF300314	5/16 BS (11/32 HS) X 1 1/4	100
WF300315	5/16 BS (11/32 HS) X 1 1/2	100
WF300375	3/8 BS (13/32 HS)	100
WF300500	1/2 BS (17/32 HS)	50

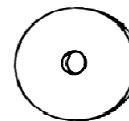
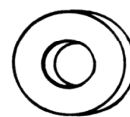

S.A.E. & FENDER

ACIER INOXYDABLE DISPONIBLE
STAINLESS STEEL AVAILABLE

AUTRES DIMENSIONS DISPONIBLES / OTHER DIMENSIONS ARE AVAILABLE



Tel.: (819) 346-2903 / (888) 345-2903 Fax.: (819) 346-3389

Email: distributeur@boulonstrie.com

NOIR / BARE

ZINC / PLATED

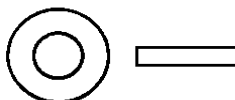

NOTRE CODE NOIR	NOTRE CODE ZINC	DIA. BOULON	DIA. INT.	DIA. EXT.	QTÉ/BTE
OUR CODE BARE	OUR CODE PLATED	BOLT SIZE	INSIDE DIA.	OUTSIDE DIA.	QTY/BOX
*****	WF600003	3 mm	3.2 mm	7.0 mm	100
*****	WF600004	4 mm	4.3 mm	9.0 mm	100
WF500005	WF600005	5 mm	5.3 mm	10.0 mm	100
WF500006	WF600006	6 mm	6.4 mm	12.0 mm	100
WF500007	WF600007	7 mm	7.4 mm	14.0 mm	100
WF500008	WF600008	8 mm	8.4 mm	16.0 mm	100
WF500010	WF600010	10 mm	10.5 mm	20.0 mm	100
WF500012	WF600012	12 mm	13.0 mm	24.0 mm	100
WF500014	WF600014	14 mm	15.0 mm	28.0 mm	50
WF500016	WF600016	16 mm	17.0 mm	30.0 mm	50
WF500018	WF600018	18 mm	19.0 mm	34.0 mm	25
WF500020	WF600020	20 mm	21.0 mm	37.0 mm	10
WF500022	*****	22 mm	23.0 mm	39.0 mm	10
WF500024	WF600024	24 mm	25.0 mm	44.0 mm	10
WF500030	WF600030	30 mm	31.0 mm	56.0 mm	10

RONDELLES PLATES
MÉTRIQUE
GRADE A-2

DIN 125 A
SS-304

FLAT WASHERS
METRIC
GRADE A-2

NOTRE CODE	DIA. BOULON	DIA. INT.	DIA. EXT.
OUR CODE	BOLT SIZE	INSIDE DIA.	OUTSIDE DIA.
WS500003	3 mm	3.2	7.0
WS500004	4 mm	4.3	9.0
WS500005	5 mm	5.3	10.0
WS500006	6 mm	6.4	12.0
WS500008	8 mm	8.4	16.0
WS500010	10 mm	10.5	20.0
WS500012	12 mm	13.0	24.0
WS500014	14 mm	15.0	28.0
WS500017	16 mm	17.0	30.0
WS500018	18 mm	19.0	34.0

AUTRES DIMENSIONS DISPONIBLES / OTHER DIMENSIONS ARE AVAILABLE

SS-316 / A-4 AUSSI DISPONIBLE / SS-316 / A-4 ALSO AVAILABLE



Tel.: (819) 346-2903 / (888) 345-2903 Fax.: (819) 346-3389

Email: distributeur@boulonstrie.com

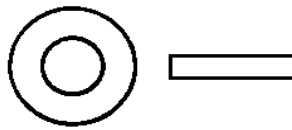

NOTRE CODE	DIA. BOULON	DIA. INT.	DIA. EXT.	QTÉ/BTE
OUR CODE	BOLT SIZE	INSIDE DIA.	OUTSIDE DIA.	QTY/BOX
WB10004	#4	.120	.281	100
WB10006	#6	.147	.312	100
WB100126	#6 L	.147	.375	100
WB100008	#8	.172	.375	100
WB100157	#8 L	.172	.437	100
WB100010	#10	.200	.437	100
WB100188	#10 L	.200	.500	100
WB100012	#12	.228	.500	100
WB100013	#12 L	.228	.562	100
WB100250	1/4	.260	.562	100
WB100251	1/4 L	.260	.687	100
WB100315	5/16	.340	.750	100
WB100316	5/16 L	.340	.875	100
WB100375	3/8	.392	.875	100
WB100376	3/8 L	.392	1.000	100
*****	7/16	.500	1.125	50
WB100500	1/2	.562	1.250	50
*****	1/2 L	.562	1.375	50
WB100562	9/16	.625	1.500	25
WB100625	5/8	.687	1.500	25
*****	5/8 L	.687	1.750	25
WB100750	3/4	.812	1.875	20
*****	3/4 L	.812	2.000	20
*****	7/8	.937	2.250	20
WB101000	1	1.062	2.500	15
WB101125	1 1/8	1.187	2.750	15
*****	1 1/4	1.313	3.000	15
WB101500	1 1/2	1.562	3.500	10

AUTRES DIMENSIONS DISPONIBLES / OTHER DIMENSIONS ARE AVAILABLE



Tel.: (819) 346-2903 / (888) 345-2903 Fax.: (819) 346-3389

Email: distributeur@boulonstrie.com

RONDELLES PLATES
GALVANISÉES À CHAUD

H.D.G.

FLAT WASHERS
HOT DIPPED GALVANIZED

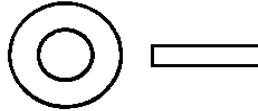

NOTRE CODE	DIA. BOULON	DIA. INT.	DIA. EXT.	QTÉ/BTE
OUR CODE	BOLT SIZE	INSIDE DIA.	OUTSIDE DIA.	QTY/BOX
WG000250	1/4	5/16	3/4	100
WG000315	5/16	3/8	7/8	100
WG000375	3/8	7/16	1	100
WG000500	1/2	9/16	1 3/8	50
WG000562	9/16	11/16	1 3/4	25
WG000625	5/8	13/16	2	25
WG000750	3/4	15/16	2 1/4	20
WG001000	1	1- 1/16	2 1/2	20
*****	1 1/8	1 -1/4	2 3/4	20
*****	1 1/4	1 5/16	2 3/4	20

RONDELLES DE TENSION ZINC DICHROMATE
TENSION WASHERS ZINC DICHROMATE

L-9

RONDELLES PLATES

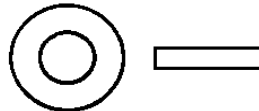

FLAT WASHERS

NOTRE CODE	DIA. BOULON	MAX	MIN	MAX	MIN	QTÉ/BTE
OUR CODE	BOLT SIZE	INSIDE DIA.		OUTSIDE DIA.		QTY/BOX
WG900250	1/4	0.286	0.276	0.640	0.620	100
WG900315	5/16	0.349	0.339	0.703	0.681	100
WG900375	3/8	0.411	0.401	0.827	0.805	100
WG900437	7/16	0.474	0.464	0.937	0.915	50
WG900500	1/2	0.536	0.526	1.092	1.055	50
WG900562	9/16	0.599	0.589	1.186	1.149	25
WG900625	5/8	0.663	0.649	1.342	1.305	25
WG900750	3/4	0.819	0.805	1.499	1.462	20
WG900875	7/8	0.945	0.931	1.780	1.743	20
WG901000	1	1.069	1.055	2.030	1.993	20
WG901125	1 1/8	1.195	1.181	2.030	1.993	15
WG901250	1 1/4	1.319	1.305	2.280	2.243	15
WG901500	1 1/2	1.572	1.552	2.780	2.743	10



Tel.: (819) 346-2903 / (888) 345-2903 Fax.: (819) 346-3389

Email: distributeur@boulonstrie.com

D-6

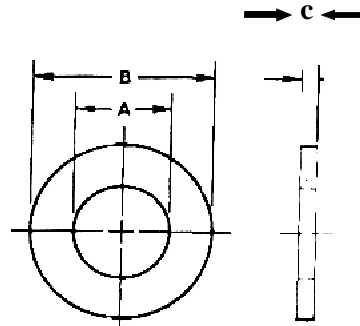

NOTRE CODE	DIM. RONDELLE	A	B	C	
		DIA. INT	DIA. EXT.	MIN	MAX
OUR CODE	WASHER SIZE	INSIDE DIA.	OUTSIDE DIA.	THICKNESS	
WS200500	1/2	1 1/16	17/32	0.097	0.177
WS200625	5/8	1 5/16	11/16	0.122	0.177
WS200750	3/4	1 15/32	13/16	0.122	0.177
WS200875	7/8	1 3/4	15/16	0.136	0.177
WS201000	1	2	1 1/8	0.136	0.177
WS201125	1 1/8	2 1/4	1 1/4	0.136	0.177
WS201250	1 1/4	2 1/2	1 3/8	0.136	0.177
*****	1 3/8	2 3/4	1 1/2	0.136	0.177
WS201500	1 1/2	3	1 5/8	0.136	0.177

DISPONIBLE / AVAILABLE

**ZINC OU JAUNE
PLATED OR YELLOW**

H.D.G.



Tel.: (819) 346-2903 / (888) 345-2903 Fax.: (819) 346-3389

Email: distributeur@boulonsestrie.com

**RONDELLES BOMBÉES
AVEC CAOUTCHOUC**

BONDED WASHERS



NOTRE CODE	DESCRIPTION	QTÉ/BTE
OUR CODE	DESCRIPTION	QTY/BOX
WB000008	#8 BS (1/2 O.D)	100
WB000010	#10 BS (1/2 O.D)	100
WB000014	1/4 BS (5/8 O.D)	100
WB000020	5/16 BS (3/4 O.D)	100
WB000037	3/8 BS (1 O.D)	100

AUSSI DISPONIBLE / ALSO AVAILABLE : SS304

**RONDELLES
D'EMPLACEMENT
ACIER NOIR**

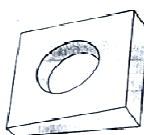

**BEVEL WASHERS
BARE STEEL**

NOTRE CODE	DESCRIPTION	QTÉ/BTE
OUR CODE	DESCRIPTION	QTY/BOX
WB000375	3/8	100
WB000500	1/2	50
WB000625	5/8	25
WB000750	3/4	20
WB000875	7/8	20
WB001000	1	20

AUSSI DISPONIBLE ... ALSO AVAILABLE ...



**RONDELLES PLATES EN NYLON
NYLON FLAT WASHERS**

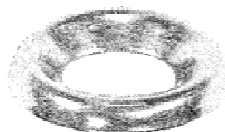

**RONDELLES DE FINITION
COUNTERSUNK
FINISHING WASHERS**



**(Nord-lock)
RONDELLES DE BLOCAGE
LOCK WASHERS**



**RONDELLES DE BLOCAGE "Belleville"
LOCK WASHERS DISC SPRINGS**

ET AUTRES ... & OTHERS ...



NOTRE CODE NOIR	NOTRE CODE ZINC	DESCRIPTION	LARGEUR	EPAISSEUR
OUR CODE BARE	OUR CODE PLATED	DESCRIPTION	WIDTH	THICKNESS
*****	WL200004	#4	.040"	.031"
WL100005	*****	#5	.047"	.031"
WL100006	WL200006	#6	.047"	.031"
*****	WL200008	#8	.055"	.040"
WL100187	WL200010	#10 (3/16)	.062"	.047"
WL100250	WL200250	1/4	.109"	.062"
WL100315	WL200315	5/16	.125"	.078"
WL100375	WL200375	3/8	.141"	.094"
WL100437	WL200437	7/16	.156"	.109"
WL100500	WL200500	1/2	.171"	.125"
WL100562	WL200562	9/16	.188"	.141"
WL100625	WL200625	5/8	.203"	.156"
WL100750	WL200750	3/4	.234"	.188"
WL100875	WL200875	7/8	.266"	.219"
WL101000	WL201000	1	.297"	.250"
WL101125	*****	1 1/8	.328"	.281"
WL101250	WL201250	1 1/4	.359"	.312"
WL101375	WL201375	1 3/8	.391"	.344"
WL101500	WL201500	1 1/2	.422"	.375"
WL102000	-	2	.500"	.375"

RONDELLES DE BLOCAGE
À COLLET ÉLEVÉ

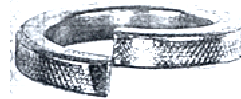

LOCK WASHERS
HIGH COLLAR

MODÈLE
À COLLET ÉLEVÉ
EST UTILISÉ
AVEC :



VIS À TÊTE
CYLINDRIQUE
À 6 PANS CREUX

NOTRE CODE	DESCRIPTION	QTÉ/BTE
OUR CODE	DESCRIPTION	QTY/BOX
WL210006	#6	100
WL210008	#8	100
WL210012	#12	100
WL210187	#10	100
WL210250	1/4	100
WL210315	5/16	100
WL210375	3/8	100
WL210437	7/16	50
WL210500	1/2	50
WL210562	9/16	25
WL210625	5/8	25
WL210750	3/4	20
WL210875	7/8	20
WL211000	1	20

HIGH-COLLAR
STYLE IS USED
WITH :



SOCKET HEAD
CAP SCREWS

RONDELLES DE BLOCAGE
EN ACIER INOXYDABLE

18-8
SS-304

LOCK WASHERS
STAINLESS STEEL



NOTRE CODE	DESCRIPTION	LARGEUR	EPAISSEUR	QTÉ/BTE
OUR CODE	DESCRIPTION	WIDTH	THICKNESS	QTY/BOX
WL600002	#2	.035"	.020"	100
WL600004	#4	.040"	.031"	100
WL600006	#6	.047"	.031"	100
WL600008	#8	.055"	.040"	100
WL600010	#10	.062"	.047"	100
WL600012	#12	.070"	.056"	100
WL600250	1/4	.109"	.062"	100
WL600315	5/16	.125"	.078"	100
WL600375	3/8	.141"	.094"	100
WL600437	7/16	.156"	.109"	50
WL600500	1/2	.171"	.125"	50
WL600562	9/16	.188"	.141"	25
WL600625	5/8	.203"	.156"	25
WL600750	3/4	.234"	.188"	20
WL600875	7/8	.266"	.219"	20
WL601000	1	.297"	.250"	20
WL601125	1 1/8	.328"	.281"	20

SS-316 EST AUSSI DISPONIBLE / SS-316 ALSO AVAILABLE

RONDELLES DE BLOCAGE
ACIER ALLOY



LOCK WASHERS
ALLOY STEEL

NOTRE CODE	DESCRIPTION	QTÉ/BTE
OUR CODE	DESCRIPTION	QTY/BOX
WL900187	3/16	100
WL900250	1/4	100
WL900315	5/16	100
WL900375	3/8	100
WL900437	7/16	50
WL900500	1/2	50
WL900625	5/8	25
WL900750	3/4	20
WL900875	7/8	
WL901000	1	20
WL901125	1 1/8	20
WL901250	1 1/4	20
WL901500	1 1/2	10

RONDELLES DE BLOCAGE
GALVANISÉES À CHAUD

H.D.G

LOCK WASHERS
HOT DIPPED GALVANIZED



NOTRE CODE	DESCRIPTION	QTÉ/BTE
OUR CODE	DESCRIPTION	QTY/BOX
WM100250	1/4	100
WM100315	5/16	100
WM100375	3/8	100
WM100500	1/2	50
WM100625	5/8	25
WM100750	3/4	20

SILICONE BRONZE

RONDELLES DE BLOCAGE
(EQUIVALENT LAITON)



LOCK WASHERS
(BRASS EQUIVALENT)

NOTRE CODE	DESCRIPTION	LARGEUR	EPAISSEUR
OUR CODE	DESCRIPTION	WIDTH	THICKNESS
WM200006	#6	.047"	.031"
WM200008	#8	.055"	.040"
WM200010	#10	.062"	.047"
WM200250	1/4	.109"	.062"
WM200315	5/16	.125"	.078"
WM200375	3/8	.141"	.094"
WM200437	7/16	.156"	.109"
WM200500	1/2	.171"	.125"
WM200625	5/8	.203"	.156"
WM200750	3/4	.234"	.188"
WM200875	7/8	.266"	.219"

AUTRES DIMENSIONS DISPONIBLES / OTHER DIMENSIONS ARE AVAILABLE



Tel.: (819) 346-2903 / (888) 345-2903 Fax.: (819) 346-3389
Email: distributeur@boulonsestrie.com

RONDELLES DE BLOCAGE
MÉTRIQUE
DIN 127B

NOIR / BARE
ZINC / PLATED

LOCK WASHERS
METRIC
DIN 127B



NOTRE CODE NOIR	OUR CODE ZINC	DESCRIPTION	INSIDE	OUTSIDE	THICK-
OUR CODE BARE	OUR CODE PLATED	DESCRIPTION	DIA.	DIA.	NESS
WL50003	WL510003	3 mm	3,1	6,2	0,8
WL50004	WL510004	4 mm	4,1	7,6	0,9
WL50005	WL510005	5 mm	5,1	9,2	1,2
WL50006	WL510006	6 mm	6,1	11,8	1,6
WL50007	*****	7 mm	7,1	12,8	1,6
WL50008	WL510008	8 mm	8,1	14,8	2
WL50010	WL510010	10 mm	10,2	18,1	2,2
WL50012	WL510012	12 mm	12,2	21,1	2,5
WL50014	*****	14 mm	14,2	24,1	3
WL50016	WL510016	16 mm	16,2	27,4	3,5
WL50018	WL510018	18 mm	18,2	29,4	3,5
WL50020	WL510020	20 mm	20,2	33,6	4
WL50022	*****	22 mm	22,5	35,9	4
WL50024	*****	24 mm	24,5	40	5
*****	*****	27 mm	27,5	43	5
*****	*****	30 mm	30,5	48,2	6
*****	*****	33 mm	33,5	55,2	6

AUTRES DIMENSIONS DISPONIBLES / OTHER DIMENSIONS ARE AVAILABLE

RONDELLES DE BLOCAGE
MÉTRIQUE

LOCK WASHERS
METRIC

SS-304 / A-2 / 18-8

SS-316 / A-4

NOTRE CODE SS-304	NOTRE CODE SS-316	DESCRIPTION	INSIDE	OUTSIDE	THICK-
OUR CODE SS-304	OUR CODE SS-316	DESCRIPTION	DIA.	DIA.	NESS
WL70003	*****	3 mm	3,1	6,2	0,8
WL70004	*****	4 mm	4,1	7,6	0,9
WL70005	*****	5 mm	5,1	9,2	1,2
WL70006	*****	6 mm	6,1	11,8	1,6
WL70008	*****	8 mm	8,1	14,8	2
WL70010	WL800010	10 mm	10,2	18,1	2,2
WL70012	WL800012	12 mm	12,2	21,1	2,5
WL70014	*****	14 mm	14,2	24,1	3
WL70016	*****	16 mm	16,2	27,4	3,5
WL70020	WL800020	20 mm	20,2	33,6	4

ZINC / PLATED

RONDELLES
DE BLOCAGE
EXTÉRIEUR



TOOTH LOCK
WASHERS
EXTERNAL

RONDELLES
DE BLOCAGE
INTÉRIEUR



TOOTH LOCK
WASHERS
INTERNAL

DISPONIBLE / AVAILABLE : SS

NOTRE CODE	DESCRIPTION	QTÉ/BTE
OUR CODE	DESCRIPTION	QTY/BOX
*****	#4	100
WL30006	#6	100
WL30008	#8	100
WL30010	#10	100
*****	#12	100
WL300250	1/4	100
WL300315	5/16	100
WL300375	3/8	100
WL300437	7/16	50
WL300500	1/2	50
WL300562	9/16	25
WL300625	5/8	25
WL300750	3/4	20
WL300875	7/8	20
WL301000	1	20

DISPONIBLE / AVAILABLE : SS

NOTRE CODE	DESCRIPTION	QTÉ/BTE
OUR CODE	DESCRIPTION	QTY/BOX
WL400002	#2	100
WL400004	#4	100
WL400006	#6	100
WL400008	#8	100
WL400010	#10	100
*****	#12	100
WL400250	1/4	100
WL400315	5/16	100
WL400375	3/8	100
WL400500	1/2	50
WL400562	9/16	25
WL400625	5/8	25
WL400750	3/4	20
WL400875	7/8	20
*****	1	20

AUSSI DISPONIBLE ... ALSO AVAILABLE ...

RONDELLES
DE BLOCAGE
EXTÉRIEUR
82 DEGRÉS



COUNTERSUNK

TOOTH LOCK
WASHERS
EXTERNAL
82 DEGRES

RONDELLES
DE BLOCAGE
EXTÉRIEUR-
INTÉRIEUR

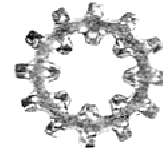

TOOTH LOCK
WASHERS
EXTERNAL -
INTERNAL

NOTRE CODE	DESCRIPTION	QTÉ/BTE
OUR CODE	DESCRIPTION	QTY/BOX
*****	#6	100
*****	#8	100
*****	#10	100
*****	#12	100
*****	1/4	100
*****	9/32	100
*****	5/16	100
*****	3/8	100
*****	7/16	50
*****	1/2	50

NOTRE CODE	DESCRIPTION	QTÉ/BTE
OUR CODE	DESCRIPTION	QTY/BOX
*****	#6	100
*****	#8	100
*****	#10	100
*****	1/4	100
*****	5/16	100
*****	3/8	100
*****	1/2	50
*****	5/8	25

SECTION E











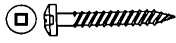
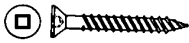

VIS / SCREWS

INFORMATION TECHNIQUE.....DÉBUT DE LA SECTION
TECHNICAL INFORMATION.....BEGINNING OF THIS SECTION

		DESCRIPTION	SECTION-PAGE
	 ROUND	VIS MÉCANIQUE À PRISE FENDUE, <i>TÊTE RONDE</i> , ZINC. MACHINE SCREWS, SLOT DRIVE, <i>ROUND HEAD</i> , PLATED.	E-1
	 FLAT	VIS MÉCANIQUE À PRISE FENDUE, <i>TÊTE PLATE</i> , ZINC. MACHINE SCREWS, SLOT DRIVE, <i>FLAT HEAD</i> , PLATED.	E-1
	 ROUND	VIS MÉCANIQUE À PRISE CARRÉE, <i>TÊTE RONDE</i> , ZINC. MACHINE SCREWS, SQUARE DRIVE, <i>ROUND HEAD</i> , PLATED.	E-5
	 FLAT	VIS MÉCANIQUE À PRISE CARRÉE, <i>TÊTE PLATE</i> , ZINC. MACHINE SCREWS, SQUARE DRIVE, <i>FLAT HEAD</i> , PLATED.	E-5
	 ROUND	VIS MÉCANIQUE COMBINÉE ÉTOILE & CARRÉE, <i>TÊTE RONDE</i> , ZINC. MACHINE SCREWS, QUADREX DRIVE, <i>ROUND HEAD</i> , PLATED.	E-9
	 FLAT	VIS MÉCANIQUE COMBINÉE ÉTOILE & CARRÉE, <i>TÊTE PLATE</i> , ZINC. MACHINE SCREWS, QUADREX DRIVE, <i>FLAT HEAD</i> , PLATED.	E-9
 ROUND	 FLAT	VIS MÉCANIQUE PRISE ÉTOILE , <i>TÊTE PLATE & RONDE</i> ZINC. MACH. SCREWS, PHILIPS DRIVE, <i>FLAT & ROUND HEAD</i> , PL.	SUR DEMANDE ON REQUEST
 ROUND	 FLAT	VIS MÉCANIQUE À PRISE FENDUE, <i>TÊTE RONDE & PLATE</i> , SS-304. MACH. SCR., SLOT DRIVE, <i>ROUND & FLAT HEAD</i> , SS-304.	SUR DEMANDE ON REQUEST
 ROUND	 ROUND	VIS MÉCANIQUE À PRISE ÉTOILE, <i>TÊTE RONDE</i> , SS-304. MACHINE SCREWS, PHILLIPS DRIVE, <i>ROUND HEAD</i> , SS-304.	E-11
 FLAT	 FLAT	VIS MÉCANIQUE À PRISE ÉTOILE, <i>TÊTE PLATE</i> , SS-304. MACHINE SCREWS, PHILLIPS DRIVE, <i>FLAT HEAD</i> , SS-304.	E-11
	 ROUND	VIS MÉCANIQUE À PRISE FENDUE, <i>TÊTE RONDE</i> , BRASS. MACHINE SCREWS, SLOT DRIVE, <i>ROUND HEAD</i> , BRASS.	E-15
	 FLAT	VIS MÉCANIQUE À PRISE FENDUE, <i>TÊTE PLATE</i> , BRASS. MACHINE SCREWS, SLOT DRIVE, <i>FLAT HEAD</i> , BRASS.	E-15

SECTION E

VIS / SCREWS

	DESCRIPTION	SECTION - PAGE
	VIS À BOIS, PRISE CARRÉE, <i>TÊTE RONDE</i> , ZINC. WOOD SCREWS, SQUARE DRIVE, <i>ROUND HEAD</i> , PLATED.	E-18
	VIS À BOIS, PRISE CARRÉE, <i>TÊTE PLATE</i> , ZINC. WOOD SCREWS, SQUARE DRIVE, <i>FLAT HEAD</i> , PLATED.	E-22
	VIS À MÉTAL, PRISE CARRÉE, <i>TÊTE RONDE</i> , ZINC. TAPPING SCREWS, SQUARE DRIVE, <i>ROUND HEAD</i> , PLATED.	E-26
	VIS À MÉTAL, PRISE CARRÉE, <i>TÊTE PLATE</i> , ZINC. TAPPING SCREWS, SQUARE DRIVE, <i>FLAT HEAD</i> , PLATED.	E-29
	VIS À MÉTAL, PRISE CARRÉE, <i>TÊTE RONDE</i> , SS-304. TAPPING SCREWS, SQUARE DRIVE, <i>ROUND HEAD</i> , SS-304.	E-31
	VIS À MÉTAL, PRISE CARRÉE, <i>TÊTE PLATE</i> , SS-304. TAPPING SCREWS, SQUARE DRIVE, <i>FLAT HEAD</i> , SS-304.	E-33
	VIS À MÉTAL, COMBINÉE ÉTOILE & CARRÉE, <i>TÊTE PLATE</i> , ZINC. TAPPING SCREWS, QUADREX DRIVE, <i>FLAT HEAD</i> , PLATED.	SUR DEMANDE ON REQUEST
	VIS À MÉTAL, PRISE QUADREX, <i>TÊTE RONDE</i> , ZINC. TAPPING SCREWS, QUADREX, <i>ROUND HEAD</i> , PLATED.	SUR DEMANDE ON REQUEST
	VIS TARAUDEUSES À 6 PANS, TYPE "A". TAPPING SCREWS, <i>HEX HEAD</i> , TYPE "A".	E-35
	VIS TARAUDEUSES À 6 PANS, <i>PRISE FENDUE</i> , TYPE AB. TAPPING SCREW, <i>SLOTTED HEX HEAD</i> , TYPE AB.	SUR DEMANDE ON REQUEST
	VIS TARAUDEUSES À 6 PANS, <i>PRISE FENDU AVEC RONDELLE</i> , TYPE AB. TAPPING SCREW, <i>SLOTTED HEX WASHER HEAD</i> , TYPE AB.	SUR DEMANDE ON REQUEST
	VIS À FILETAGE COUPANT. THREAD-CUTTING SCREWS.	SUR DEMANDE ON REQUEST
	VIS AUTO-PERÇANTE, <i>TÊTE HEX</i> , ZINC. <i>HEX HEAD "TEK" SCREWS</i> , PLATED.	E-36

SECTION E

VIS / SCREWS

	DESCRIPTION	SECTION - PAGE
	VIS AUTO-PERÇANTE, TÊTE HEX, SS-410. <i>HEX HEAD "TEK" SCREWS, SS-410.</i>	E-37
	VIS À TOITURE, TÊTE HEXAGONAL AVEC RONDELLE D'ACIER. <i>ROOFING SCREWS, HEXAGONE HEAD, WITH STEEL WASHER.</i>	SUR DEMANDE ON REQUEST
	VIS AUTO-PERÇANTE, TÊTE RONDE , ZINC. <i>PAN HEAD "TEK" SCREWS, PLATED.</i>	E-38
	VIS AUTO-PERÇANTE, TÊTE RONDE , SS-410. <i>PAN HEAD "TEK" SCREWS, SS-410.</i>	SUR DEMANDE ON REQUEST
	VIS AUTO-PERÇANTE, TÊTE PLATE , ZINC. <i>FLAT HEAD "TEK" SCREWS, PLATED.</i>	E-39
	VIS AUTO-PERÇANTE, TÊTE WAFER , PRISE CARRÉE, ZINC. <i>"WAFER" TEK SCREWS, SQUARE DRIVE, PLATED.</i>	E-39
	VIS AUTO-PERÇANTE "TEK" TÊTE RONDE QUADREX (POUR CHEMINÉE). <i>PAN HEAD QUADREX "TEK" SCREWS (FOR FIREPLACE).</i>	E-40
	FAUSSE VIS TYPE "U". <i>DRIVE SCREW TYPE "U".</i>	SUR DEMANDE ON REQUEST
	VIS À PLANCHER DE CAMION, PRISE TORX. <i>FLOORBOARD SCREWS, TORX DRIVE.</i>	E-40
	VIS À PLANCHER DE CAMION, PRISE CARRÉE. <i>FLOORBOARD SCREWS, SQUARE DRIVE.</i>	E-40
	VIS POUR BOIS TRAITÉ, TÊTE PLATE, ENDUIT DE CÉRAMIQUE, VEI <i>PRESSURE THREADED FLAT WOOD SCREWS CERAMIC COATING, GREEN.</i>	E-41
	VIS POUR BOIS TRAITÉ, TÊTE PLATE, ZINC CHROMATE, JAUNE. <i>PRESSURE THREADED FLAT WOOD SCREWS, YELLOW CHROMATE.</i>	E-41
	VIS À PLANCHER, PRISE CARRÉE, TÊTE PLATE, NOIR. <i>FLOOR SCREWS, SQUARE DRIVE, FLAT HEAD, PLAIN.</i>	E-42
	VIS À BÉTON, PRISE CARRÉE, TÊTE HEXAGONALE , JAUNE. <i>CONCRETE SCREWS, SQUARE DRIVE, HEX HEAD, YELLOW.</i>	E-43

SECTION E

VIS / SCREWS

	DESCRIPTION	SECTION - PAGE
	VIS À BÉTON, PRISE CARRÉE, TÊTE PLATE , JAUNE. CONCRETE SCREWS, SQUARE DRIVE, FLAT HEAD, YELLOW.	E-43
	VIS À BÉTON "TAPCON", TÊTE HEXAGONALE , BLEU. CONCRETE SCREWS "TAPCON", HEX HEAD , BLUE.	E-44
	VIS À BÉTON "TAPCON", ÉTOILE, TÊTE PLATE , BLEU. CONCRETE SCREWS "TAPCON", PHILIPS, FLAT HEAD , BLUE.	E-44
	VIS À GYPS TYPE "S". DRY WALL SCREWS TYPE "S".	E-45
	VIS À PARTICULE, TÊTE RONDE , "HIGH-LOW". PARTICULE BOARD SCREWS, ROUND HEAD , "HIGH-LOW".	E-45
	VIS À PARTICULE, TÊTE PLATE, "HIGH-LOW". PARTICULE BOARD SCREWS, FLAT HEAD , "HIGH-LOW".	SUR DEMANDE ON REQUEST
	GOUJONS EN ACIER. DOWEL SCREWS.	E-46
	BOULONS PATTE DE TABLE . HANGER BOLTS.	E-46
	VIS "UNDERCUT". UNDERCUT SCREWS.	SUR DEMANDE ON REQUEST
	VIS À OREILLES. WING SCREWS.	SUR DEMANDE ON REQUEST
	VIS À CLÉ. THUMB SCREWS.	SUR DEMANDE ON REQUEST
	DOUILLES. BITS.	E-47
	TOURNEVIS. SCREWDRIVERS.	E-48
	CAPUCHONS À VIS EN PLASTIQUE. PLASTIC PUSH CAPS.	E-25

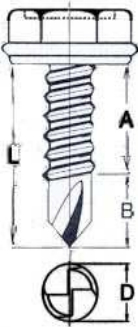
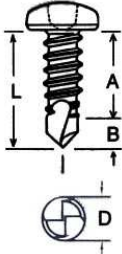
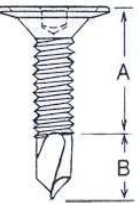
HEX WASHER HEAD								ÉPAISSEUR DU MATÉRIEL À TRAVERSER/MATERIAL
	DIMENSION	L	A	B	D	STYLE	HEX	PENETRATION RANGE
	8 X 1/2	1/2	3/8	1/8	1/8	2	1/4	.035 - .100
	8-18 X 5/8	5/8	29/64	11/64	1/8	2	1/4	.035 - .100
	8 X 3/4	3/4	9/16	3/16	1/8	2SP	1/4	.035 - .125
	10-16 X 1/2	1/2	11/32	5/32	.144	2	5/16	.035 - .110
	10-16 X 5/8	5/8	15/32	7/32	.153	3	5/16	.110 - .175
	10-16 X 3/4	3/4	17/32	7/32	.153	3	5/16	.110 - .175
	10-16 X 1	1	25/32	7/32	.153	3	5/16	.110 - .175
	12-14 X 3/4	3/4	15/32	9/32	.177	3	5/16	.110 - .210
	12-24 X 7/8	7/8	7/16	7/16	.187	3	5/16	.250
	12-14 X 1	1	23/32	9/32	.177	3	5/16	.110 - .210
	12-14 X 1 1/2	1 1/2	1	3/8	.166	3	5/16	.036 - .210
	12-14 X 2	2	1 23/32	9/32	.177	3	5/16	.110 - .210
	1/4-14 X 3/4	3/4	7/16	5/16	.205	3	3/8	.110 - .250
	1/4-14 X 1	1	11/16	5/16	.205	3	3/8	.110 - .250
	1/4-14 X 1 1/2	1 1/2	1 3/16	5/16	.205	3	3/8	.110 - .250
1/4-14 X 2	2	1 11/16	5/16	.205	3	3/8	.110 - .250	
SQUARE SOCKET PAN HEAD 	6-20 X 3/8	3/8	1/4	1/8	.106	2		.035 - .090
	6-20 X 1/2	1/2	11/32	5/32	.114	2		.090 - .110
	8-18 X 1/2	1/2	3/8	1/8	.125	2		.035 - .100
	8-18 X 5/8	5/8	1/2	1/8	.125	2		.035 - .100
	8-18 X 3/4	3/4	9/16	3/16	.125	2SP		.035 - .125
	8-18 X 1	1	13/16	3/16	.125	2SP		.035 - .125
	10-16 X 1/2	1/2	11/32	5/32	.144	2		.035 - .110
	10-16 X 3/4	3/4	19/32	5/32	.144	2		.035 - .110
	10-16 X 1	1	11/16	5/16	.144	3		.110 - .175
	10-16 X 1 1/4	1 1/4	1	1/4	.153	3		.110 - .175
PHILIPS SOCKET PAN HEAD	6-20 X 7/16	7/16	5/16	1/8	.106	2		.035 - .090
	8-18 X 1/2	1/2	3/8	1/8	.125	2		.035 - .100
	10-16 X 3/4	3/4	19/32	5/32	.144	3		.035 - .110
SQUARE WAFFER HEAD 	10-24 X 3/4	3/4	1/2	1/4	.162	3	.470	.110 - .175
	10-24 X 1 1/4	1 1/4	23/32	17/32	.162	3	.470	.110 - .175
	10-24 X 1 7/16	1	7/16	.162	.162	3	.470	.110 - .175
	12-24 X 2	2	1 1/2	1/2	.187	3	.540	.210 - 5 ga.
	12-24 X 2 1/2	2 1/2	2	1/2	.187	4	.540	.250 - 1/4



NOTRE CODE TÊTE RONDE	NOTRE CODE TÊTE PLATE	DESCRIPTION	QTÉ/BTE
OUR CODE ROUND HEAD	OUR CODE FLAT HEAD	DESCRIPTION	QTY/BOX
MS202001	*****	2-56 X 3/16	100
MS204004	*****	4-40 X 3/8	100
*****	MS104005	4-40 X 1/2	100
*****	MS104007	4-40 X 3/4	100
*****	MS104010	4-40 X 1	100
MS205003	*****	5-40 X 5/16	100
MS205004	*****	5-40 X 7/16	100
*****	MS105005	5-40 X 1/2	100
MS205007	*****	5-40 X 3/4	100
MS205008	MS105008	5-40 X 7/8	100
*****	MS105010	5-40 X 1	100
MS205012	MS105012	5-40 X 1 1/4	100
MS205015	MS105015	5-40 X 1 1/2	100
*****	MS105017	5-40 X 1 3/4	100
*****	MS105020	5-40 X 2	100
MS206001	*****	6-32 X 3/16	100
MS206004	*****	6-32 X 3/8	100
MS206005	MS106005	6-32 X 1/2	100
MS206006	MS106006	6-32 X 5/8	100
*****	MS106007	6-32 X 3/4	100
*****	MS106008	6-32 X 7/8	100
MS206010	*****	6-32 X 1	100
MS206015	*****	6-32 X 1 1/2	100
*****	MS106017	6-32 X 1 3/4	100
MS206020	*****	6-32 X 2	100
MS206025	MS106025	6-32 X 2 1/2	100
MS206030	MS106030	6-32 X 3	100
MS206040	*****	6-32 X 4	100
MS208002	MS108002	8-32 X 1/4	100
*****	MS108003	8-32 X 5/16	100

AUTRES DIMENSIONS DISPONIBLES / OTHER DIMENSIONS ARE AVAILABLE



Tel.: (819) 346-2903 / (888) 345-2903 Fax.: (819) 346-3389

Email: distributeur@boulonstrie.com

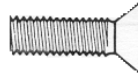

NOTRE CODE TÊTE RONDE	NOTRE CODE TÊTE PLATE	DESCRIPTION	QTÉ/BTE
OUR CODE ROUND HEAD	OUR CODE FLAT HEAD	DESCRIPTION	QTY/BOX
MS208004	MS108004	8-32 X 3/8	100
MS208005	*****	8-32 X 1/2	100
MS208006	MS108006	8-32 X 5/8	100
MS208007	MS108007	8-32 X 3/4	100
MS208008	*****	8-32 X 7/8	100
MS208010	*****	8-32 X 1	100
*****	MS108012	8-32 X 1 1/4	100
MS208015	*****	8-32 X 1 1/2	100
*****	MS108017	8-32 X 1 3/4	100
MS208020	MS108020	8-32 X 2	100
*****	MS108030	8-32 X 3	100
*****	MS110002	10-24 X 1/4	100
*****	MS110003	10-24 X 3/8	100
*****	MS110004	10-24 X 7/16	100
MS210005	MS110005	10-24 X 1/2	100
*****	MS110006	10-24 X 5/8	100
MS210007	MS110007	10-24 X 3/4	100
MS210010	MS110010	10-24 X 1	100
MS210012	*****	10-24 X 1 1/4	100
MS210015	MS110015	10-24 X 1 1/2	100
MS210017	MS110017	10-24 X 1 3/4	100
MS210020	MS110020	10-24 X 2	100
*****	MS110022	10-24 X 2 1/4	100
MS210025	MS110025	10-24 X 2 1/2	100
*****	MS110027	10-24 X 2 3/4	100
MS210030	*****	10-24 X 3	100
MS210040	*****	10-24 X 4	100
MS211002	MS111002	10-32 X 5/16	100
MS211003	MS111003	10-32 X 3/8	100
*****	MS111004	10-32 X 7/16	100

AUTRES DIMENSIONS DISPONIBLES / OTHER DIMENSIONS ARE AVAILABLE



Tel.: (819) 346-2903 / (888) 345-2903 Fax.: (819) 346-3389

Email: distributeur@boulonstrie.com

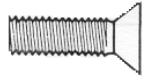

NOTRE CODE TÊTE RONDE	NOTRE CODE TÊTE PLATE	DESCRIPTION	QTÉ/BTE
OUR CODE ROUND HEAD	OUR CODE FLAT HEAD	DESCRIPTION	QTY/BOX
MS211005	MS111005	10-32 X 1/2	100
MS211006	MS111006	10-32 X 5/8	100
MS211007	MS111007	10-32 X 3/4	100
MS211010	MS111010	10-32 X 1	100
MS211012	MS111012	10-32 X 1 1/4	100
MS211015	MS111015	10-32 X 1 1/2	100
MS211020	MS111020	10-32 X 2	100
MS211022	*****	10-32 X 2 1/4	100
MS211025	*****	10-32 X 2 1/2	100
*****	MS111030	10-32 X 3	100
MS212002	*****	12-24 X 1/4	100
MS212003	*****	12-24 X 3/8	100
MS212012	*****	12-24 X 1 1/4	100
MS225003	MS125004	1/4-20 X 3/8	100
MS225005	MS125005	1/4-20 X 1/2	100
*****	MS125006	1/4-20 X 5/8	100
MS225007	MS125007	1/4-20 X 3/4	100
MS225010	MS125010	1/4-20 X 1	100
MS225012	MS125012	1/4-20 X 1 1/4	100
MS225015	MS125015	1/4-20 X 1 1/2	100
*****	MS125017	1/4-20 X 1 3/4	100
MS225020	MS125020	1/4-20 X 2	100
MS225022	MS125022	1/4-20 X 2 1/4	100
MS225025	MS125025	1/4-20 X 2 1/2	100
*****	MS125035	1/4-20 X 3 1/2	100
*****	MS125040	1/4-20 X 4	100
*****	MS131005	5/16-18 X 1/2	100
*****	MS131007	5/16-18 X 3/4	100
MS231010	MS131010	5/16-18 X 1	100
*****	MS131012	5/16-18 X 1 1/4	100

AUTRES DIMENSIONS DISPONIBLES / OTHER DIMENSIONS ARE AVAILABLE



Tel.: (819) 346-2903 / (888) 345-2903 Fax.: (819) 346-3389

Email: distributeur@boulonstrie.com



NOTRE CODE TÊTE RONDE	NOTRE CODE TÊTE PLATE	DESCRIPTION	QTÉ/BTE
OUR CODE ROUND HEAD	OUR CODE FLAT HEAD	DESCRIPTION	QTY/BOX
*****	MS131015	5/16-18 X 1 1/2	100
*****	MS131017	5/16-18 X 1 3/4	100
*****	MS131020	5/16-18 X 2	100
*****	MS131025	5/16-18 X 2 1/2	100
*****	MS131035	5/16-18 X 3 1/2	100
*****	MS137005	3/8-16 X 1/2	100
MS237007	MS137007	3/8-16 X 3/4	100
*****	MS137008	3/8-16 X 7/8	100
MS237010	MS137010	3/8-16 X 1	100
*****	MS137012	3/8-16 X 1 1/4	100
*****	MS137015	3/8-16 X 1 1/2	100
*****	MS137017	3/8-16 X 1 3/4	100
MS237020	MS137020	3/8-16 X 2	100
MS237025	MS137025	3/8-16 X 2 1/2	100
*****	MS137035	3/8-16 X 3 1/2	100
*****	MS143020	7/16-14 X 2	50
*****	MS150012	1/2-13 X 1 1/4	50
*****	MS150015	1/2-13 X 1 1/2	50
*****	MS150020	1/2-13 X 2	50
*****	MS150025	1/2-13 X 2 1/2	50
*****	MS162010	5/8-11 X 1	50
*****	MS162012	5/8-11 X 1 1/4	50
*****	MS162015	5/8-11 X 1 1/2	50
*****	MS162035	5/8-11 X 3 1/2	50
*****	MS175015	3/4-10 X 1 1/2	20
*****	MS175017	3/4-10 X 1 3/4	20
*****	MS175020	3/4-10 X 2	20
*****	MS175030	3/4-10 X 3	20

AUTRES DIMENSIONS DISPONIBLES / OTHER DIMENSIONS ARE AVAILABLE



Tel.: (819) 346-2903 / (888) 345-2903 Fax.: (819) 346-3389

Email: distributeur@boulonstrie.com



NOTRE CODE TÊTE RONDE	NOTRE CODE TÊTE PLATE	DESCRIPTION	QTÉ/BTE
OUR CODE ROUND HEAD	OUR CODE FLAT HEAD	DESCRIPTION	QTY/BOX
MS404002	*****	4-40 X 1/4	100
MS404004	MS304004	4-40 X 3/8	100
MS404005	*****	4-40 X 1/2	100
MS404006	*****	4-40 X 5/8	100
MS404007	MS304007	4-40 X 3/4	100
MS404010	MS304010	4-40 X 1	100
MS406002	*****	6-32 X 1/4	100
MS406004	MS306004	6-32 X 3/8	100
MS406005	MS306005	6-32 X 1/2	100
MS406006	MS306006	6-32 X 5/8	100
MS406007	MS306007	6-32 X 3/4	100
MS406008	*****	6-32 X 7/8	100
MS406010	MS306010	6-32 X 1	100
MS406012	MS306012	6-32 X 1 1/4	100
MS406015	MS306015	6-32 X 1 1/2	100
MS406017	MS306017	6-32 X 1 3/4	100
MS406020	MS306020	6-32 X 2	100
MS406025	MS306025	6-32 X 2 1/2	100
MS406030	MS306030	6-32 X 3	100
MS406040	MS306040	6-32 X 4	100
MS408001	*****	8-32 X 3/16	100
MS408002	MS308002	8-32 X 1/4	100
MS408003	MS308003	8-32 X 5/16	100
MS408004	MS308004	8-32 X 3/8	100
MS408005	MS308005	8-32 X 1/2	100
MS408006	MS308006	8-32 X 5/8	100
MS408007	MS308007	8-32 X 3/4	100

AUTRES DIMENSIONS DISPONIBLES / OTHER DIMENSIONS ARE AVAILABLE



Tel.: (819) 346-2903 / (888) 345-2903 Fax.: (819) 346-3389
Email: distributeur@boulonstrie.com

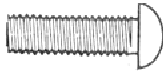

NOTRE CODE TÊTE RONDE	NOTRE CODE TÊTE PLATE	DESCRIPTION	QTÉ/BTE
OUR CODE ROUND HEAD	OUR CODE FLAT HEAD	DESCRIPTION	QTY/BOX
MS408010	MS308010	8-32 X 1	100
*****	MS308011	8-32 X 1 1/8	100
MS408012	MS308012	8-32 X 1 1/4	100
MS408015	MS308015	8-32 X 1 1/2	100
MS408017	MS308017	8-32 X 1 3/4	100
MS408020	MS308020	8-32 X 2	100
MS408022	*****	8-32 X 2 1/4	100
MS408025	MS308025	8-32 X 2 1/2	100
MS408030	MS308030	8-32 X 3	100
MS410002	*****	10-24 X 1/4	100
MS410003	*****	10-24 X 5/16	100
MS410004	MS310003	10-24 X 3/8	100
MS410005	MS310005	10-24 X 1/2	100
MS410006	MS310006	10-24 X 5/8	100
MS410007	MS310007	10-24 X 3/4	100
MS410010	MS310010	10-24 X 1	100
MS410012	MS310012	10-24 X 1 1/4	100
MS410015	MS310015	10-24 X 1 1/2	100
MS410017	MS310017	10-24 X 1 3/4	100
MS410020	MS310020	10-24 X 2	100
MS410025	MS310025	10-24 X 2 1/2	100
MS410030	MS310030	10-24 X 3	100
MS410035	MS310035	10-24 X 3 1/2	100
MS410040	MS310040	10-24 X 4	100
MS411002	MS311002	10-32 X 1/4	100
MS411003	MS311004	10-32 X 3/8	100
MS411005	MS311005	10-32 X 1/2	100

AUTRES DIMENSIONS DISPONIBLES / OTHER DIMENSIONS ARE AVAILABLE



Tel.: (819) 346-2903 / (888) 345-2903 Fax.: (819) 346-3389
Email: distributeur@boulonstrie.com

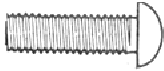

NOTRE CODE TÊTE RONDE	NOTRE CODE TÊTE PLATE	DESCRIPTION	QTÉ/BTE
OUR CODE ROUND HEAD	OUR CODE FLAT HEAD	DESCRIPTION	QTY/BOX
MS411006	MS311006	10-32 X 5/8	100
MS411007	MS311007	10-32 X 3/4	100
MS411010	MS311010	10-32 X 1	100
MS411012	MS311012	10-32 X 1 1/4	100
MS411015	MS311015	10-32 X 1 1/2	100
MS411017	MS311017	10-32 X 1 3/4	100
MS411020	MS311020	10-32 X 2	100
MS411025	MS311025	10-32 X 2 1/2	100
MS411030	MS311030	10-32 X 3	100
MS425004	*****	1/4-20 X 3/8	100
MS425005	MS325005	1/4-20 X 1/2	100
MS425006	MS325006	1/4-20 X 5/8	100
MS425007	MS325007	1/4-20 X 3/4	100
MS425010	MS325010	1/4-20 X 1	100
MS425012	MS325012	1/4-20 X 1 1/4	100
MS425015	MS325015	1/4-20 X 1 1/2	100
MS425017	MS325017	1/4-20 X 1 3/4	100
MS425020	MS325020	1/4-20 X 2	100
MS425022	MS325022	1/4-20 X 2 1/4	100
MS425025	MS325025	1/4-20 X 2 1/2	100
MS425030	MS325030	1/4-20 X 3	100
MS425035	MS325035	1/4-20 X 3 1/2	100
MS425040	MS325040	1/4-20 X 4	100
MS425050	*****	1/4-20 X 5	100
MS431005	*****	5/16-18 X 1/2	100
MS431007	MS331007	5/16-18 X 3/4	100
MS431010	MS331010	5/16-18 X 1	100

AUTRES DIMENSIONS DISPONIBLES / OTHER DIMENSIONS ARE AVAILABLE



Tel.: (819) 346-2903 / (888) 345-2903 Fax.: (819) 346-3389
Email: distributeur@boulonstrie.com

**VIS MÉCANIQUE
PRISE CARRÉE
TÊTE RONDE ET PLATE**

ZINC / PLATED

**MACHINE SCREWS
SQUARE DRIVE
ROUND AND FLAT HEAD**

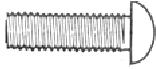

NOTRE CODE TÊTE RONDE	NOTRE CODE TÊTE PLATE	DESCRIPTION	QTÉ/BTE
OUR CODE ROUND HEAD	OUR CODE FLAT HEAD	DESCRIPTION	QTY/BOX
MS431012	MS331012	5/16-18 X 1 1/4	100
MS431015	MS331015	5/16-18 X 1 1/2	100
MS431017	MS331017	5/16-18 X 1 3/4	100
MS431020	MS331020	5/16-18 X 2	100
MS431025	MS331025	5/16-18 X 2 1/2	100
MS431030	MS331030	5/16-18 X 3	100
MS431035	MS331035	5/16-18 X 3 1/2	100
MS431040	MS331040	5/16-18 X 4	100
MS437010	*****	3/8-16 X 1	100
MS437025	*****	3/8-16 X 2 1/2	100

AUTRES DIMENSIONS DISPONIBLES / OTHER DIMENSIONS ARE AVAILABLE



**Tel.: (819) 346-2903 / (888) 345-2903 Fax.: (819) 346-3389
Email: distributeur@boulonsestrie.com**

**VIS À MACHINE COMBINÉE
TOURNEVIS CARRÉ ET ÉTOILE
TÊTE RONDE ET PLATE**

ZINC / PLATED

**MACHINE SCREWS
QUADREX
ROUND AND FLAT HEAD**

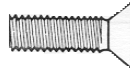

NOTRE CODE TÊTE RONDE	NOTRE CODE TÊTE PLATE	DESCRIPTION	QTÉ/BTE
OUR CODE ROUND HEAD	OUR CODE FLAT HEAD	DESCRIPTION	QTY/BOX
MQ406002	MQ306002	6-32 X 1/4	100
MQ406004	*****	6-32 X 3/8	100
MQ406005	MQ306005	6-32 X 1/2	100
MQ406007	*****	6-32 X 3/4	100
MQ406010	*****	6-32 X 1	100
MQ406015	*****	6-32 X 1 1/2	100
MQ406017	*****	6-32 X 1 3/4	100
MQ408002	*****	8-32 X 1/4	100
MQ408004	*****	8-32 X 3/8	100
MQ408005	MQ308005	8-32 X 1/2	100
MQ408006	*****	8-32 X 5/8	100
MQ408007	*****	8-32 X 3/4	100
MQ408010	*****	8-32 X 1	100
MQ408015	*****	8-32 X 1 1/2	100
MQ408017	*****	8-32 X 1 3/4	100
MQ408020	*****	8-32 X 2	100
MQ410004	MQ310004	10-24 X 3/8	100
MQ410005	MQ310005	10-24 X 1/2	100
MQ410006	*****	10-24 X 5/8	100
MQ410007	MQ310007	10-24 X 3/4	100
MQ410010	MQ310010	10-24 X 1	100
MQ410012	*****	10-24 X 1 1/4	100
MQ410015	MQ310015	10-24 X 1 1/2	100
MQ410017	*****	10-24 X 1 3/4	100
MQ410020	*****	10-24 X 2	100
MQ411002	MQ311002	10-32 X 1/4	100
MQ411004	MQ311004	10-32 X 3/8	100
MQ411005	MQ311005	10-32 X 1/2	100
MQ411006	MQ311006	10-32 X 5/8	100

AUTRES DIMENSIONS DISPONIBLES / OTHER DIMENSIONS ARE AVAILABLE



Tel.: (819) 346-2903 / (888) 345-2903 Fax.: (819) 346-3389

Email: distributeur@boulonstrie.com

VIS À MACHINE COMBINÉE
TOURNEVIS CARRÉ ET ÉTOILE
TÊTE RONDE ET PLATE

ZINC / PLATED

MACHINE SCREWS
QUADREX
ROUND AND FLAT HEAD



NOTRE CODE TÊTE RONDE	NOTRE CODE TÊTE PLATE	DESCRIPTION	QTÉ/BTE
OUR CODE ROUND HEAD	OUR CODE FLAT HEAD	DESCRIPTION	QTY/BOX
MQ411007	MQ311007	10-32 X 3/4	100
MQ411010	MQ311010	10-32 X 1	100
MQ411012	MQ311012	10-32 X 1 1/4	100
MQ411015	MQ311015	10-32 X 1 1/2	100
*****	MQ311017	10-32 X 1 3/4	100
MQ411020	MQ311020	10-32 X 2	100
MQ411025	MQ311025	10-32 X 2 1/2	100
MQ411030	MQ311030	10-32 X 3	100
MQ425005	MQ325005	1/4 X 1/2	100
MQ425006	*****	1/4 X 5/8	100
MQ425007	MQ325007	1/4 X 3/4	100
MQ425010	MQ325010	1/4 X 1	100
MQ425012	MQ325012	1/4 X 1 1/4	100
MQ425015	MQ325015	1/4 X 1 1/2	100
*****	MQ325017	1/4 X 1 3/4	100
MQ425020	*****	1/4 X 2	100
MQ425022	*****	1/4 X 2 1/4	100
MQ425025	MQ325025	1/4 X 2 1/2	100
MQ425030	MQ325030	1/4 X 3	100

AUTRES DIMENSIONS DISPONIBLES / OTHER DIMENSIONS ARE AVAILABLE



Tel.: (819) 346-2903 / (888) 345-2903 Fax.: (819) 346-3389

Email: distributeur@boulonsestrie.com



NOTRE CODE TÊTE RONDE	NOTRE CODE TÊTE PLATE	DESCRIPTION	QTÉ/BTE
OUR CODE ROUND HEAD	OUR CODE FLAT HEAD	DESCRIPTION	QTY/BOX
MS702001	MS802001	2-56 X 3/16	100
MS702002	MS802002	2-56 X 1/4	100
MS702004	MS802004	2-56 X 3/8	100
MS702006	*****	2-56 X 5/8	100
MS704002	*****	4-40 X 1/4	100
MS704003	MS804003	4-40 X 5/16	100
MS704007	*****	4-40 X 3/4	100
MS704010	MS804010	4-40 X 1	100
MS705002	*****	5-40 X 1/4	100
MS705004	*****	5-40 X 3/8	100
MS706002	*****	6-32 X 1/4	100
*****	MS806003	6-32 X 5/16	100
MS706004	MS806004	6-32 X 3/8	100
MS706005	*****	6-32 X 1/2	100
MS706007	*****	6-32 X 3/4	100
MS706010	*****	6-32 X 1	100
MS706015	*****	6-32 X 1 1/2	100
MS706017	*****	6-32 X 1 3/4	100
MS706020	MS806020	6-32 X 2	100
MS708002	MS808002	8-32 X 1/4	100
MS708003	*****	8-32 X 5/16	100
MS708004	MS808004	8-32 X 3/8	100
MS708005	MS808005	8-32 X 1/2	100
MS708006	*****	8-32 X 5/8	100
MS708007	MS808007	8-32 X 3/4	100
MS708010	MS808010	8-32 X 1	100
MS708012	MS808012	8-32 X 1 1/4	100
MS708015	MS808015	8-32 X 1 1/2	100
MS708020	*****	8-32 X 2	100

AUTRES DIMENSIONS DISPONIBLES / OTHER DIMENSIONS ARE AVAILABLE



Tel.: (819) 346-2903 / (888) 345-2903 Fax.: (819) 346-3389

Email: distributeur@boulonsestrie.com



NOTRE CODE TÊTE RONDE	NOTRE CODE TÊTE PLATE	DESCRIPTION	QTÉ/BTE
OUR CODE ROUND HEAD	OUR CODE FLAT HEAD	DESCRIPTION	QTY/BOX
MS708025	*****	8-32 X 2 1/2	100
MS710002	*****	10-24 X 1/4	100
MS710003	MS810004	10-24 X 3/8	100
MS710005	MS810005	10-24 X 1/2	100
MS710006	MS810006	10-24 X 5/8	100
MS710007	MS810007	10-24 X 3/4	100
MS710008	*****	10-24 X 7/8	100
MS710010	MS810010	10-24 X 1	100
MS710012	*****	10-24 X 1 1/4	100
MS710015	MS810015	10-24 X 1 1/2	100
MS710017	*****	10-24 X 1 3/4	100
MS710020	*****	10-24 X 2	100
MS710025	MS810025	10-24 X 2 1/2	100
MS710030	*****	10-24 X 3	100
MS710040	*****	10-24 X 4	100
MS710050	*****	10-24 X 5	100
*****	MS811002	10-32 X 1/4	100
MS711003	MS811004	10-32 X 3/8	100
MS711005	MS811005	10-32 X 1/2	100
MS711006	MS811006	10-32 X 5/8	100
MS711007	MS811007	10-32 X 3/4	100
MS711010	MS811010	10-32 X 1	100
MS711012	MS811012	10-32 X 1 1/4	100
MS711015	*****	10-32 X 1 1/2	100
MS711017	*****	10-32 X 1 3/4	100
MS711020	*****	10-32 X 2	100
MS711025	*****	10-32 X 2 1/2	100
MS711030	*****	10-32 X 3	100
MS712005	*****	12-24 X 1/2	100

AUTRES DIMENSIONS DISPONIBLES / OTHER DIMENSIONS ARE AVAILABLE



Tel.: (819) 346-2903 / (888) 345-2903 Fax.: (819) 346-3389

Email: distributeur@boulonsestrie.com



NOTRE CODE TÊTE RONDE	NOTRE CODE TÊTE PLATE	DESCRIPTION	QTÉ/BTE
OUR CODE ROUND HEAD	OUR CODE FLAT HEAD	DESCRIPTION	QTY/BOX
MS712010	*****	12-24 X 1	100
MS712015	*****	12-24 X 1 1/2	100
MS712017	*****	12-24 X 1 3/4	100
MS712020	*****	12-24 X 2	100
MS725004	*****	1/4-20 X 3/8	100
MS725005	MS825005	1/4-20 X 1/2	100
*****	MS825006	1/4-20 X 5/8	100
MS725007	MS825007	1/4-20 X 3/4	100
MS725010	MS825010	1/4-20 X 1	100
MS725012	MS825012	1/4-20 X 1 1/4	100
MS725015	MS825015	1/4-20 X 1 1/2	100
MS725020	MS825020	1/4-20 X 2	100
MS725022	*****	1/4-20 X 2 1/4	100
MS725025	MS825025	1/4-20 X 2 1/2	100
MS725030	MS825030	1/4-20 X 3	100
MS731005	MS831005	5/16-18 X 1/2	100
MS731006	MS831006	5/16-18 X 5/8	100
MS731007	MS831007	5/16-18 X 3/4	100
*****	MS831008	5/16-18 X 7/8	100
*****	MS831010	5/16-18 X 1	100
*****	MS831020	5/16-18 X 2	100
*****	MS831025	5/16-18 X 2 1/2	100
MS731050	*****	5/16-18 X 5	100
MS737005	MS837005	3/8-16 X 1/2	100
MS737006	MS837006	3/8-16 X 5/8	100
MS737007	MS837007	3/8-16 X 3/4	100
MS737008	*****	3/8-16 X 7/8	100
MS737010	*****	3/8-16 X 1	100
MS737032	*****	3/8-16 X 3 1/4	100

AUTRES DIMENSIONS DISPONIBLES / OTHER DIMENSIONS ARE AVAILABLE



Tel.: (819) 346-2903 / (888) 345-2903 Fax.: (819) 346-3389

Email: distributeur@boulonsestrie.com

VIS MÉCANIQUE
PRISE ÉTOILE
TÊTE RONDE ET PLATE

SS-304
ÉTOILE / PHILLIPS

MACHINE SCREWS
PHILLIPS DRIVE
ROUND AND FLAT HEAD



NOTRE CODE TÊTE RONDE	NOTRE CODE TÊTE PLATE	DESCRIPTION	QTÉ/BTE
OUR CODE ROUND HEAD	OUR CODE FLAT HEAD	DESCRIPTION	QTY/BOX
*****	MS850007	1/2-13 X 3/4	50
MS750010	*****	1/2-13 X 1	50
MS750015	*****	1/2-13 X 1 1/2	50

AUTRES DIMENSIONS DISPONIBLES / OTHER DIMENSIONS ARE AVAILABLE



Tel.: (819) 346-2903 / (888) 345-2903 Fax.: (819) 346-3389

Email: distributeur@boulonsestrie.com



NOTRE CODE TÊTE RONDE	NOTRE CODE TÊTE PLATE	DESCRIPTION	QTÉ/BTE
OUR CODE ROUND HEAD	OUR CODE FLAT HEAD	DESCRIPTION	QTY/BOX
MT004002	*****	4-40 X 1/4	100
MT004003	*****	4-40 X 3/8	100
MT004005	*****	4-40 X 1/2	100
MT004007	*****	4-40 X 3/4	100
MT004010	*****	4-40 X 1	100
MT005002	*****	5-40 X 1/4	100
*****	MT705004	5-40 X 3/8	100
MT005003	*****	5-40 X 5/8	100
*****	MT705005	5-40 X 1/2	100
MT006002	*****	6-32 X 1/4	100
MT006003	MT706004	6-32 X 3/8	100
MT006005	MT706005	6-32 X 1/2	100
MT006007	MT706007	6-32 X 3/4	100
MT006010	MT706010	6-32 X 1	100
MT006015	MT706015	6-32 X 1 1/2	100
MT006020	*****	6-32 X 2	100
MT008003	*****	8-32 X 5/16	100
MT008004	MT708004	8-32 X 3/8	100
MT008005	MT708005	8-32 X 1/2	100
*****	MT708006	8-32 X 5/8	100
MT008007	MT708007	8-32 X 3/4	100
MT008010	MT708010	8-32 X 1	100
MT008012	MT708012	8-32 X 1 1/4	100
MT008015	MT708015	8-32 X 1 1/2	100
MT008017	*****	8-32 X 1 3/4	100
MT008020	*****	8-32 X 2	100
*****	MT710004	10-24 X 3/8	100
MT010005	MT710005	10-24 X 1/2	100

AUTRES DIMENSIONS DISPONIBLES / OTHER DIMENSIONS ARE AVAILABLE



Tel.: (819) 346-2903 / (888) 345-2903 Fax.: (819) 346-3389

Email: distributeur@boulonstrie.com

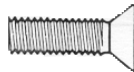

NOTRE CODE TÊTE RONDE	NOTRE CODE TÊTE PLATE	DESCRIPTION	QTÉ/BTE
OUR CODE ROUND HEAD	OUR CODE FLAT HEAD	DESCRIPTION	QTY/BOX
*****	MT710006	10-24 X 5/8	100
MT010007	MT710007	10-24 X 3/4	100
MT010010	MT710010	10-24 X 1	100
MT010012	MT710012	10-24 X 1 1/4	100
MT010015	MT710015	10-24 X 1 1/2	100
MT010020	MT710020	10-24 X 2	100
MT010025	*****	10-24 X 2 1/2	100
MT011004	*****	10-32 X 3/8	100
MT011005	MT711005	10-32 X 1/2	100
*****	MT711006	10-32 X 5/8	100
MT011007	MT711007	10-32 X 3/4	100
MT011010	MT711010	10-32 X 1	100
MT011015	MT711015	10-32 X 1 1/2	100
MT011020	*****	10-32 X 2	100
*****	MT725004	1/4-20 X 3/8	100
MT025005	MT725005	1/4-20 X 1/2	100
MT025006	*****	1/4-20 X 5/8	100
MT025007	MT725007	1/4-20 X 3/4	100
MT025010	MT725010	1/4-20 X 1	100
*****	MT725012	1/4-20 X 1 1/4	100
MT025015	MT725015	1/4-20 X 1 1/2	100
MT025020	MT725020	1/4-20 X 2	100
MT031005	MT731005	5/16-18 X 1/2	100
*****	MT731006	5/16-18 X 5/8	100
MT031007	MT731007	5/16-18 X 3/4	100
*****	MT731008	5/16-18 X 7/8	100
MT031010	MT731010	5/16-18 X 1	100
MT031012	MT731012	5/16-18 X 1 1/4	100

AUTRES DIMENSIONS DISPONIBLES / OTHER DIMENSIONS ARE AVAILABLE



Tel.: (819) 346-2903 / (888) 345-2903 Fax.: (819) 346-3389

Email: distributeur@boulonstrie.com

VIS MÉCANIQUE
 PRISE FENDUE
 TÊTE RONDE ET PLATE

LAITON / BRASS

MACHINE SCREWS
 SLOT DRIVE
 ROUND AND FLAT HEAD



NOTRE CODE TÊTE RONDE	NOTRE CODE TÊTE PLATE	DESCRIPTION	QTÉ/BTE
OUR CODE ROUND HEAD	OUR CODE FLAT HEAD	DESCRIPTION	QTY/BOX
MT031015	*****	5/16-18 X 1 1/2	100
*****	MT737005	3/8-16 X 1/2	100
*****	MT737007	3/8-16 X 3/4	100
MT037010	MT737010	3/8-16 X 1	100
MT037015	MT737015	3/8-16 X 1 1/2	100
MT037020	*****	3/8-16 X 2	100
*****	MT737022	3/8-16 X 2 1/4	100
*****	MT750007	1/2-13 X 3/4	100
*****	MT750010	1/2-13 X 1	100
*****	MT750012	1/2-13 X 1 1/4	100

AUTRES DIMENSIONS DISPONIBLES / OTHER DIMENSIONS ARE AVAILABLE



Tel.: (819) 346-2903 / (888) 345-2903 Fax.: (819) 346-3389
 Email: distributeur@boulonsestrie.com



NOTRE CODE	DESCRIPTION	QTÉ/BTE	QTÉ/VRAC
OUR CODE	DESCRIPTION	QTY/BOX	QTY/BULK
*****	2 X 1/4	100	-
*****	2 X 3/8	100	-
*****	2 X 1/2	100	-
*****	2 X 5/8	100	-
*****	3 X 1/4	100	-
VB203004	3 X 3/8	100	15000
VB203005	3 X 1/2	100	15000
VB203006	3 X 5/8	100	15000
*****	4 X 1/4	100	-
VB204004	4 X 3/8	100	40000
VB204005	4 X 1/2	100	50000
VB204006	4 X 5/8	100	30000
VB204007	4 X 3/4	100	25000
VB204008	4 X 7/8	100	20000
VB204010	4 X 1	100	18000
VB204012	4 X 1 1/4	100	12000
*****	5 X 1/4	100	-
VB205004	5 X 3/8	100	35000
VB205005	5 X 1/2	100	30000
VB205006	5 X 5/8	100	25000
VB205007	5 X 3/4	100	20000
VB205008	5 X 7/8	100	16000
VB205010	5 X 1	100	15000
VB205012	5 X 1 1/4	100	11000
VB206004	6 X 3/8	100	24000
VB206005	6 X 1/2	100	22000
VB206006	6 X 5/8	100	20000
VB206007	6 X 3/4	100	16000
VB206008	6 X 7/8	100	12000
VB206010	6 X 1	100	10000



VIS À BOIS
TÊTE RONDE
PRISE CARRÉE

ZINC / PLATED

WOOD SCREWS
ROUND HEAD
SQUARE DRIVE



NOTRE CODE	DESCRIPTION	QTÉ/BTE	QTÉ/VRAC
OUR CODE	DESCRIPTION	QTY/BOX	QTY/BULK
VB206012	6 X 1 1/4	100	9000
VB206015	6 X 1 1/2	100	6000
VB206017	6 X 1 3/4	100	6000
VB206020	6 X 2	100	4500
*****	7 X 3/8	100	-
VB207005	7 X 1/2	100	20000
VB207006	7 X 5/8	100	15000
VB207007	7 X 3/4	100	12000
VB207008	7 X 7/8	100	11000
VB207010	7 X 1	100	8000
VB207012	7 X 1 1/4	100	7000
VB207015	7 X 1 1/2	100	6000
VB207020	7 X 2	100	-
VB208005	8 X 1/2	100	15000
VB208006	8 X 5/8	100	12000
VB208007	8 X 3/4	100	10000
VB208010	8 X 1	100	8000
VB208012	8 X 1 1/4	100	6000
VB208015	8 X 1 1/2	100	5000
VB208017	8 X 1 3/4	100	4000
VB208020	8 X 2	100	3000
VB208022	8 X 2 1/4	100	3000
VB208025	8 X 2 1/2	100	2000
VB208030	8 X 3	100	2000
VB208035	8 X 3 1/2	100	1000
VB208040	8 X 4	100	800
VB209005	9 X 1/2	100	13000
*****	9 X 5/8	100	-
VB209007	9 X 3/4	100	10000
VB209008	9 X 7/8	100	8000



Tel.: (819) 346-2903 / (888) 345-2903 Fax.: (819) 346-3389

Email: distributeur@boulonstrie.com

E-19



NOTRE CODE	DESCRIPTION	QTÉ/BTE	QTÉ/VRAC
OUR CODE	DESCRIPTION	QTY/BOX	QTY/BULK
VB209010	9 X 1	100	7000
VB209012	9 X 1 1/4	100	6000
VB209015	9 X 1 1/2	100	4500
VB209017	9 X 1 3/4	100	3000
VB209020	9 X 2	100	3000
*****	9 X 2 1/4	100	-
VB209025	9 X 2 1/2	100	2000
VB210004	10 X 3/8	100	-
VB210005	10 X 1/2	100	10000
VB210006	10 X 5/8	100	8000
VB210007	10 X 3/4	100	6500
VB210010	10 X 1	100	7000
VB210012	10 X 1 1/4	100	5000
VB210015	10 X 1 1/2	100	3000
VB210017	10 X 1 3/4	100	300
VB210020	10 X 2	100	2500
VB210022	10 X 2 1/4	100	2500
VB210025	10 X 2 1/2	100	2000
VB210030	10 X 3	100	1500
VB210035	10 X 3 1/2	100	1000
VB210040	10 X 4	100	1000
VB212005	12 X 1/2	100	-
VB212006	12 X 5/8	100	-
VB212007	12 X 3/4	100	5000
VB212010	12 X 1	100	5000
VB212012	12 X 1 1/4	100	4000
VB212015	12 X 1 1/2	100	3000
VB212017	12 X 1 3/4	100	2500
VB212020	12 X 2	100	2500
VB212022	12 X 2 1/4	100	1500



VIS À BOIS
TÊTE RONDE
PRISE CARRÉE

ZINC / PLATED

WOOD SCREWS
ROUND HEAD
SQUARE DRIVE



NOTRE CODE	DESCRIPTION	QTÉ/BTE	QTÉ/VRAC
OUR CODE	DESCRIPTION	QTY/BOX	QTY/BULK
VB212025	12 X 2 1/2	100	1500
VB212030	12 X 3	100	1500
VB212035	12 X 3 1/2	100	1100
VB212040	12 X 4	100	600
VB214007	14 X 3/4	100	5000
VB214010	14 X 1	100	4000
VB214012	14 X 1 1/4	100	2500
VB214015	14 X 1 1/2	100	2500
VB214017	14 X 1 3/4	100	2000
VB214020	14 X 2	100	1500
VB214022	14 X 2 1/4	100	1500
VB214025	14 X 2 1/2	100	1500
VB214030	14 X 3	100	1000
VB214035	14 X 3 1/2	100	700
VB214040	14 X 4	100	500



Tel.: (819) 346-2903 / (888) 345-2903 Fax.: (819) 346-3389

Email: distributeur@boulonsestrie.com



NOTRE CODE	DESCRIPTION	QTÉ/BTE	QTÉ/VRAC
OUR CODE	DESCRIPTION	QTY/BOX	QTY/BULK
*****	2 X 1/4	100	-
*****	2 X 3/8	100	-
*****	2 X 1/2	100	-
*****	2 X 5/8	100	-
*****	3 X 1/4	100	-
VB103004	3 X 3/8	100	-
VB103005	3 X 1/2	100	-
VB103006	3 X 5/8	100	-
*****	4 X 1/4	100	-
VB104004	4 X 3/8	100	50000
VB104005	4 X 1/2	100	40000
VB104006	4 X 5/8	100	20000
VB104007	4 X 3/4	100	25000
VB104010	4 X 1	100	18000
VB104012	4 X 1 1/4	100	12000
*****	5 X 1/4	100	-
VB105004	5 X 3/8	100	40000
VB105005	5 X 1/2	100	30000
VB105006	5 X 5/8	100	25000
VB105007	5 X 3/4	100	20000
VB105008	5 X 7/8	100	18000
VB105010	5 X 1	100	15000
VB105012	5 X 1 1/4	100	12000
VB106004	6 X 3/8	100	30000
VB106005	6 X 1/2	100	26000
VB106006	6 X 5/8	100	22000
VB106007	6 X 3/4	100	18000
VB106008	6 X 7/8	100	12000
VB106010	6 X 1	100	11000
VB106012	6 X 1 1/4	100	30000





NOTRE CODE	DESCRIPTION	QTÉ/BTE	QTÉ/VRAC
OUR CODE	DESCRIPTION	QTY/BOX	QTY/BULK
VB106015	6 X 1 1/2	100	26000
VB106017	6 X 1 3/4	100	18000
VB106020	6 X 2	100	5000
*****	7 X 3/8	100	-
VB107005	7 X 1/2	100	20000
VB107006	7 X 5/8	100	15000
VB107007	7 X 3/4	100	10000
VB107008	7 X 7/8	100	11000
VB107010	7 X 1	100	8000
VB107012	7 X 1 1/4	100	7000
VB107015	7 X 1 1/2	100	6000
VB107020	7 X 2	100	-
VB108005	8 X 1/2	100	15000
VB108006	8 X 5/8	100	12000
VB108007	8 X 3/4	100	12000
VB108010	8 X 1	100	10000
VB108012	8 X 1 1/4	100	7000
VB108015	8 X 1 1/2	100	5000
VB108017	8 X 1 3/4	100	-
VB108020	8 X 2	100	3000
VB108022	8 X 2 1/4	100	3000
VB108025	8 X 2 1/2	100	2500
VB108030	8 X 3	100	2000
VB108035	8 X 3 1/2	100	1800
VB108040	8 X 4	100	900
VB109005	9 X 1/2	100	13000
*****	9 X 5/8	100	-
VB109007	9 X 3/4	100	10000
*****	9 X 7/8	100	-
VB109010	9 X 1	100	12000





NOTRE CODE	DESCRIPTION	QTÉ/BTE	QTÉ/VRAC
OUR CODE	DESCRIPTION	QTY/BOX	QTY/BULK
VB109012	9 X 1 1/4	100	6000
VB109015	9 X 1 1/2	100	5000
VB109017	9 X 1 3/4	100	3000
VB109020	9 X 2	100	5000
*****	9 X 2 1/4	100	-
VB109025	9 X 2 1/2	100	2500
*****	9 X 3	100	-
VB110005	10 X 1/2	100	10000
VB110006	10 X 5/8	100	-
VB110007	10 X 3/4	100	9000
VB110010	10 X 1	100	7000
VB110012	10 X 1 1/4	100	6000
VB110015	10 X 1 1/2	100	4500
VB110017	10 X 1 3/4	100	6000
VB110020	10 X 2	100	3000
VB110022	10 X 2 1/4	100	2500
VB110025	10 X 2 1/2	100	2000
VB110030	10 X 3	100	2500
VB110035	10 X 3 1/2	100	1000
VB110040	10 X 4	100	1000
VB110050	10 X 5	100	-
VB110060	10 X 6	100	-
VB112007	12 X 3/4	100	5000
VB112010	12 X 1	100	4000
VB112012	12 X 1 1/4	100	4000
VB112015	12 X 1 1/2	100	2500
VB112017	12 X 1 3/4	100	2500
VB112020	12 X 2	100	2000
VB112022	12 X 2 1/4	100	1500
VB112025	12 X 2 1/2	100	1500



VIS À BOIS
TÊTE PLATE
PRISE CARRÉE

ZINC / PLATED

WOOD SCREWS
FLAT HEAD
SQUARE DRIVE



NOTRE CODE	DESCRIPTION	QTÉ/BTE	QTÉ/VRAC
OUR CODE	DESCRIPTION	QTY/BOX	QTY/BULK
VB112030	12 X 3	100	1300
VB112035	12 X 3 1/2	100	1100
VB112040	12 X 4	100	600
VB114007	14 X 3/4	100	5000
VB114010	14 X 1	100	4000
VB114012	14 X 1 1/4	100	2500
VB114015	14 X 1 1/2	100	2500
VB114017	14 X 1 3/4	100	2000
VB114020	14 X 2	100	1500
VB114022	14 X 2 1/4	100	1500
VB114025	14 X 2 1/2	100	1500
VB114030	14 X 3	100	1000
VB114035	14 X 3 1/2	100	700
VB114040	14 X 4	100	500

AUTRES DIMENSIONS DISPONIBLES / OTHER DIMENSIONS ARE AVAILABLE

CAPUCHONS À VIS
EN PLASTIQUE



PLASTIC
PUSH CAPS

NOTRE CODE	DESCRIPTION	QTY/BTE
OUR CODE	DESCRIPTION	QTÉ/BOX
CP000081	CAP DE FINITION GRIS # 8 (SOCKET NO 2)	50
CP000082	CAP DE FINITION NOIR # 8 (SOCKET NO 2)	50
CP000083	CAP DE FINITION BLANC # 8 (SOCKET NO 2)	50

AUTRES DIMENSIONS & COULEURS DISPONIBLES /
OTHER DIMENSIONS & COLOR ARE AVAILABLE



Tel.: (819) 346-2903 / (888) 345-2903 Fax.: (819) 346-3389
Email: distributeur@boulonsestrie.com

E-25



NOTRE CODE	DESCRIPTION	QTÉ/BTE	QTÉ/VRAC
OUR CODE	DESCRIPTION	QTY/BOX	QTY/BULK
VM104002	4 X 1/4	100	60000
VM104004	4 X 3/8	100	15000
VM104005	4 X 1/2	100	-
VM104006	4 X 5/8	100	15000
VM104007	4 X 3/4	100	15000
VM104010	4 X 1	100	13000
*****	4 X 1 1/4	100	-
*****	4 X 1 1/2	100	-
VM106002	6 X 1/4	100	26000
VM106003	6 X 5/16	100	15000
VM106004	6 X 3/8	100	26000
VM106005	6 X 1/2	100	22000
VM106006	6 X 5/8	100	19000
VM106007	6 X 3/4	100	16000
VM106010	6 X 1	100	12000
VM106012	6 X 1 1/4	100	8000
VM106015	6 X 1 1/2	100	6000
VM106017	6 X 1 3/4	100	4500
VM106020	6 X 2	100	4000
*****	7 X 5/16	100	-
VM107004	7 X 3/8	100	15000
*****	7 X 1/2	100	-
*****	7 X 5/8	100	-
VM107007	7 X 3/4	100	12000
*****	7 X 1	100	-
*****	7 X 1 1/4	100	-
*****	7 X 1 1/2	100	-
*****	7 X 1 3/4	100	-
*****	7 X 2	100	-





NOTRE CODE	DESCRIPTION	QTÉ/BTE	QTÉ/VRAC
OUR CODE	DESCRIPTION	QTY/BOX	QTY/BULK
VM108004	8 X 3/8	100	16000
VM108005	8 X 1/2	100	14000
VM108006	8 X 5/8	100	12000
VM108007	8 X 3/4	100	8000
VM108010	8 X 1	100	9000
VM108012	8 X 1 1/4	100	7000
VM108015	8 X 1 1/2	100	500
VM108017	8 X 1 3/4	100	4000
VM108020	8 X 2	100	3000
VM108025	8 X 2 1/2	100	2000
VM110004	10 X 3/8	100	11000
VM110005	10 X 1/2	100	9000
VM110006	10 X 5/8	100	6000
VM110007	10 X 3/4	100	8000
VM110010	10 X 1	100	5500
VM110012	10 X 1 1/4	100	5500
VM110015	10 X 1 1/2	100	4000
VM110017	10 X 1 3/4	100	3000
VM110020	10 X 2	100	3000
VM110025	10 X 2 1/2	100	-
*****	12 X 3/8	100	-
VM112005	12 X 1/2	100	7500
VM112006	12 X 5/8	100	6000
VM112007	12 X 3/4	100	5000
VM112010	12 X 1	100	4500
VM112012	12 X 1 1/4	100	3500
VM112015	12 X 1 1/2	100	3000
VM112017	12 X 1 3/4	100	2500
VM112020	12 X 2	100	2000



VIS À METAL
TÊTE RONDE
PRISE CARRÉE

ZINC / PLATED
TYPE A

TAPPING SCREWS
ROUND HEAD
SQUARE DRIVE



NOTRE CODE	DESCRIPTION	QTÉ/BTE	QTÉ/VRAC
OUR CODE	DESCRIPTION	QTY/BOX	QTY/BULK
VM112025	12 X 2 1/2	100	-
*****	14 X 3/8	100	-
VM114005	14 X 1/2	100	-
VM114006	14 X 5/8	100	5000
VM114007	14 X 3/4	100	3000
VM114010	14 X 1	100	4000
VM114012	14 X 1 1/4	100	3000
VM114015	14 X 1 1/2	100	2500
VM114017	14 X 1 3/4	100	2000
VM114020	14 X 2	100	1500

AUTRES DIMENSIONS DISPONIBLES / OTHER DIMENSIONS ARE AVAILABLE

TÊTES DE VIS DISPONIBLES / AVAILABLE HEAD SCREWS

OVALE



OVAL

RONDE



ROUND

PLATE



FLAT

"PAN"



PAN

TÊTE DE SUIF



TRUSS



Tel.: (819) 346-2903 / (888) 345-2903 Fax.: (819) 346-3389

Email: distributeur@boulonstrie.com



NOTRE CODE	DESCRIPTION	QTÉ/BTE	QTÉ/VRAC
OUR CODE	DESCRIPTION	QTY/BOX	QTY/BULK
*****	4 X 3/8	100	25000
*****	4 X 1/2	100	25000
VM204006	4 X 5/8	100	25000
*****	4 X 3/4	100	25000
VM204010	4 X 1	100	-
*****	4 X 1 1/4	100	-
*****	4 X 1 1/2	100	-
VM206004	6 X 3/8	100	15000
VM206005	6 X 1/2	100	31000
VM206006	6 X 5/8	100	20000
VM206007	6 X 3/4	100	18000
VM206010	6 X 1	100	11000
VM206012	6 X 1 1/4	100	10000
VM206015	6 X 1 1/2	100	8000
VM206017	6 X 1 3/4	100	5000
VM206020	6 X 2	100	5000
VM208004	8 X 3/8	100	25000
VM208005	8 X 1/2	100	19000
VM208006	8 X 5/8	100	17000
VM208007	8 X 3/4	100	14009
VM208010	8 X 1	100	9000
VM208012	8 X 1 1/4	100	9000
VM208015	8 X 1 1/2	100	5500
VM208017	8 X 1 3/4	100	5000
VM208020	8 X 2	100	3000
VM210005	10 X 1/2	100	15000
VM210006	10 X 5/8	100	8000
VM210007	10 X 3/4	100	10000
VM210010	10 X 1	100	7000





NOTRE CODE	DESCRIPTION	QTÉ/BTE	QTÉ/VRAC
OUR CODE	DESCRIPTION	QTY/BOX	QTY/BULK
VM210012	10 X 1 1/4	100	5500
VM210015	10 X 1 1/2	100	4500
VM210017	10 X 1 3/4	100	3000
VM210020	10 X 2	100	2500
*****	12 X 3/8	100	-
VM212005	12 X 1/2	100	-
VM212006	12 X 5/8	100	-
VM212007	12 X 3/4	100	-
VM212010	12 X 1	100	-
VM212012	12 X 1 1/4	100	-
VM212015	12 X 1 1/2	100	-
*****	12 X 1 3/4	100	-
VM212020	12 X 2	100	-
VM212025	12 X 2 1/2	100	-
VM214007	14 X 3/4	100	-
VM214010	14 X 1	100	3500
VM214015	14 X 1 1/2	100	-

AUTRES DIMENSIONS DISPONIBLES / OTHER DIMENSIONS ARE AVAILABLE

TÊTES DE VIS DISPONIBLES / AVAILABLE HEAD SCREWS

OVALE



OVAL

RONDE



ROUND

PLATE



FLAT

"PAN"



PAN

TÊTE DE SUIF



TRUSS



Tel.: (819) 346-2903 / (888) 345-2903 Fax.: (819) 346-3389

Email: distributeur@boulonsestrie.com

VIS À MÉTAL
TÊTE RONDE
PRISE CARRÉE
ACIER INNOXYDABLE

SS-304
TYPE A

TAPPING SCREWS
ROUND HEAD
SQUARE DRIVE
STAINLESS STEEL



NOTRE CODE	DESCRIPTION	QTÉ/BTE
OUR CODE	DESCRIPTION	QTY/BOX
VS204005	#4 X 1/2	100
VS204007	#4 X 3/4	100
VS204010	#4 X 1	100
VS206004	#6 X 3/8	100
VS206005	#6 X 1/2	100
VS206007	#6 X 3/4	100
VS206010	#6 X 1	100
VS206012	#6 X 1 1/4	100
VS206025	#6 X 2 1/2	100
VS208004	#8 X 3/8	100
VS208005	#8 X 1/2	100
VS208006	#8 X 5/8	100
VS208007	#8 X 3/4	100
VS208010	#8 X 1	100
VS208012	#8 X 1 1/4	100
VS208015	#8 X 1 1/2	100
VS208017	#8 X 1 3/4	100
VS208020	#8 X 2	100
VS208025	#8 X 2 1/2	100
VS208030	#8 X 3	100
VS210005	#10 X 1/2	100
VS210006	#10 X 5/8	100
VS210007	#10 X 3/4	100
VS210010	#10 X 1	100
VS210012	#10 X 1 1/4	100
VS210015	#10 X 1 1/2	100
VS210020	#10 X 2	100
VS210025	#10 X 2 1/2	100
VS212005	#12 X 1/2	100
VS212007	#12 X 3/4	100



Tel.: (819) 346-2903 / (888) 345-2903 Fax.: (819) 346-3389

Email: distributeur@boulonstrie.com

VIS À MÉTAL
TÊTE RONDE
PRISE CARRÉE
ACIER INNOXYDABLE

SS-304
TYPE A

TAPPING SCREWS
ROUND HEAD
SQUARE DRIVE
STAINLESS STEEL



NOTRE CODE	DESCRIPTION	QTÉ/BTE
OUR CODE	DESCRIPTION	QTY/BOX
VS212010	#12 X 1	100
VS212012	#12 X 1 1/4	100
VS212015	#12 X 1 1/2	100
VS212020	#12 X 2	100
VS214010	#14 X 1	100
VS214015	#14 X 1 1/2	100
VS214025	#14 X 2 1/2	100

AUTRES DIMENSIONS DISPONIBLES / OTHER DIMENSIONS ARE AVAILABLE

TÊTES DE VIS DISPONIBLES / AVAILABLE HEAD SCREWS

OVALE



OVAL

RONDE



ROUND

PLATE



FLAT

"PAN"



PAN



Tel.: (819) 346-2903 / (888) 345-2903 Fax.: (819) 346-3389

Email: distributeur@boulonsestrie.com

VIS À MÉTAL
TÊTE PLATE
PRISE CARRÉE
ACIER INOXYDABLE

SS-304
TYPE A

METAL SCREWS
FLAT HEAD
SQUARE DRIVE
STAINLESS STEEL



NOTRE CODE	DESCRIPTION	QTÉ/BTE
OUR CODE	DESCRIPTION	QTY/BOX
VS104006	#4 X 5/8	100
VS106004	#6 X 3/8	100
VS106005	#6 X 1/2	100
VS106006	#6 X 5/8	100
VS106007	#6 X 3/4	100
VS106010	#6 X 1	100
VS106012	#6 X 1 1/4	100
VS106015	#6 X 1 1/2	100
VS108005	#8 X 1/2	100
VS108006	#8 X 5/8	100
VS108007	#8 X 3/4	100
VS108010	#8 X 1	100
VS108012	#8 X 1 1/4	100
VS108015	#8 X 1 1/2	100
VS108017	#8 X 1 3/4	100
VS108020	#8 X 2	100
VS108025	#8 X 2 1/2	100
VS110005	#10 X 1/2	100
VS110006	#10 X 5/8	100
VS110007	#10 X 3/4	100
VS110010	#10 X 1	100
VS110012	#10 X 1 1/4	100
VS110015	#10 X 1 1/2	100
VS110020	#10 X 2	100
VS110025	#10 X 2 1/2	100
VS110030	#10 X 3	100
VS110035	#10 X 3 1/2	100
VS112007	#12 X 3/4	100
VS112010	#12 X 1	100



Tel.: (819) 346-2903 / (888) 345-2903 Fax.: (819) 346-3389

Email: distributeur@boulonstrie.com

VIS À MÉTAL
TÊTE PLATE
PRISE CARRÉE
ACIER INOXYDABLE

SS-304
TYPE A

METAL SCREWS
FLAT HEAD
SQUARE DRIVE
STAINLESS STEEL



NOTRE CODE	DESCRIPTION	QTÉ/BTE
OUR CODE	DESCRIPTION	QTY/BOX
VS112012	#12 X 1 1/4	100
VS112015	#12 X 1 1/2	100
VS112017	#12 X 1 3/4	100
VS112020	#12 X 2	100
VS112025	#12 X 2 1/2	100
VS114010	#14 X 1	100
VS114015	#14 X 1 1/2	100
VS114020	#14 X 2	100
VS114025	#14 X 2 1/2	100
VS114030	#14 X 3	100

AUTRES DIMENSIONS DISPONIBLES / OTHER DIMENSIONS ARE AVAILABLE

TÊTES DE VIS DISPONIBLES / AVAILABLE HEAD SCREWS

OVALE



OVAL

RONDE



ROUND

PLATE



FLAT

"PAN"



PAN



Tel.: (819) 346-2903 / (888) 345-2903 Fax.: (819) 346-3389

Email: distributeur@boulonsestrie.com



NOTRE CODE	DESCRIPTION	QTÉ/BTE
OUR CODE	DESCRIPTION	QTY/BOX
VA006004	6 X 3/8	100
VA008004	8 X 3/8	100
VA008005	8 X 1/2	100
VA008006	8 X 5/8	100
VA008007	8 X 3/4	100
VA008010	8 X 1	100
VA008012	8 X 1 1/4	100
VA008015	8 X 1 1/2	100
VA008020	8 X 2	100
VA010004	10 X 3/8	100
VA010005	10 X 1/2	100
VA010010	10 X 1	100
VA010012	10 X 1 1/4	100
VA010015	10 X 1 1/2	100
VA010020	10 X 2	100
VA012005	12 X 1/2	100
VA012007	12 X 3/4	100
VA012012	12 X 1 1/4	100
VA012015	12 X 1 1/2	100
VA014005	14 X 1/2	100
VA014006	14 X 5/8	100
VA014007	14 X 3/4	100
VA014008	14 X 7/8	100
VA014010	14 X 1	100
VA014012	14 X 1 1/4	100
VA014015	14 X 1 1/2	100
VA014020	14 X 2	100
VA031007	5/16 X 3/4	100
VA031010	5/16 X 1	100
VA031012	5/16 X 1 1/4	100
VA031015	5/16 X 1 1/2	100
VA037010	3/8 X 1	100



← 6 PANS, PRISE FENDUE/
SLOTTED HEX HEAD

AUSSI DISPONIBLE / ALSO AVAILABLE
VIS À FILETAGE COUPANT

VIS TYPE AB
6 PANS, PRISE FENDUE,
AVEC RONDELLE /
SLOTTED HEX
WASHER HEAD



THREAD-CUTTING SCREWS

E-35

TÊTE HEXAGONALE



HEXAGONE HEAD

NOTRE CODE	DESCRIPTION	QTÉ/BTE
OUR CODE	DESCRIPTION	QTY/BOX
VT088005	8-18 X 1/2	100
VT088006	8-18 X 5/8	100
VT088007	8-18 X 3/4	100
VT088010	8-18 X 1	100
VT088012	8-18 X 1 1/4	100
VT088015	8-18 X 1 1/2	100
VT088020	8-18 X 2	100
VT106005	10-16 X 1/2	100
VT106006	10-16 X 5/8	100
VT106007	10-16 X 3/4	100
VT106010	10-16 X 1	100
VT106012	10-16 X 1 1/4	100
VT106015	10-16 X 1 1/2	100
VT106020	10-16 X 2	100
VT106025	10-16 X 2 1/2	100
VT124007	12-14 X 3/4	100
VT124008	12-24 X 7/8	100
VT124010	12-14 X 1	100
VT124012	12-14 X 1 1/4	100
VT124013	12-24 X 1 1/4	100
VT124015	12-14 X 1 1/2	100
VT124020	12-14 X 2	100
VT124021	12-24 X 2	100
VT124030	12-14 X 3	100
VT140007	14-14 X 3/4	100
VT140008	14-14 X 7/8	100
VT140010	14-14 X 1	100
VT140012	14-14 X 1 1/4	100

AUTRES DIMENSIONS DISPONIBLES/OTHER DIMENSIONS ARE AVAILABLE



Tel.: (819) 346-2903 / (888) 345-2903 Fax.: (819) 346-3389

Email: distributeur@boulonsestrie.com

TÊTE HEXAGONALE



HEXAGONE HEAD

NOTRE CODE	DESCRIPTION	QTÉ/BTE
OUR CODE	DESCRIPTION	QTY/BOX
VT140015	14-14 X 1 1/2	100
VT140020	14-14 X 2	100
VT140022	14-14 X 2 1/4	100
VT140025	14-14 X 2 1/2	100
VT140030	14-14 X 3	100
VT140040	14-14 X 4	100

AUTRES DIMENSIONS DISPONIBLES / OTHER DIMENSIONS ARE AVAILABLE

VIS AUTO-PERÇANTES

STAINLESS STEEL

"TEK" SCREWS

TÊTE HEXAGONALE

410

HEXAGONE HEAD

NOTRE CODE	DESCRIPTION
OUR CODE	DESCRIPTION
VS308005	8-18 X 1/2
VS308007	8-18 X 3/4
VS308010	8-18 X 1
VS310005	10 X 1/2
VS310007	10 X 3/4
VS310010	10 X 1"
VS312007	12 X 3/4
VS312010	12 X 1
VS314007	14 X 3/4
VS314010	14 X 1
VS314012	14 X 1 1/4

EN SS-410:
CORPS, FILETS & POINTE
BODY, THREADS & POINT
(ANSI B18.6.4)

TENSION / TENSILE
180 000 psi heat-treated

AUTRES DIMENSIONS DISPONIBLES / OTHER DIMENSIONS ARE AVAILABLE



Tel.: (819) 346-2903 / (888) 345-2903 Fax.: (819) 346-3389

Email: distributeur@boulonstrie.com

TÊTE RONDE



PAN HEAD

NOTRE CODE	DESCRIPTION	QTÉ/BTE
OUR CODE	DESCRIPTION	QTY/BOX
VP060002	6-20 X 3/8	100
VP060004	6-20 X 7/16	100
VP060005	6-20 X 1/2	100
VP088005	8-18 X 1/2	100
VP088006	8-18 X 5/8	100
VP088007	8-18 X 3/4	100
VP088010	8-18 X 1	100
VP088012	8-18 X 1 1/4	100
VP088015	8-18 X 1 1/2	100
VP088020	8-18 X 2	100
VP106005	10-16 X 1/2	100
VT106006	10-16 X 5/8	100
VP106007	10-16 X 3/4	100
VP106010	10-16 X 1	100
VP106012	10-16 X 1 1/4	100
VP106015	10-16 X 1 1/2	100
VP106020	10-16 X 2	100

AUTRES DIMENSIONS DISPONIBLES / OTHER DIMENSIONS ARE AVAILABLE

AUSSI DISPONIBLE / ALSO AVAILABLE**ACIER INOXYDABLE / STAINLESS STEEL****SS-410**

Tel.: (819) 346-2903 / (888) 345-2903 Fax.: (819) 346-3389

Email: distributeur@boulonsestrie.com

E-38

VIS AUTO-PERÇANTES
TÊTE PLATE
PRISE CARRÉE

ZINC / PLATED

"TEK" SCREWS
FLAT HEAD
SQUARE DRIVE



NOTRE CODE	DESCRIPTION	QTÉ/BTE	QTÉ/VRAC
OUR CODE	DESCRIPTION	QTY/BOX	QTY/BULK
VF108005	8-18 X 1/2	100	10000
VF108007	8-18 X 3/4	100	10000
VF108010	8-18 X 1	100	7500
VF108012	8-18 X 1 1/4	100	5000
VF108015	8-18 X 1 1/2	100	5000

VIS AUTO-PERÇANTES
TÊTE WAFER
PRISE CARRÉE

ZINC / PLATED

SOCKET WAFER HEAD



"TEK" SCREWS
SQUARE DRIVE

NOTRE CODE	DESCRIPTION	QTÉ/BTE	QTÉ/VRAC
OUR CODE	DESCRIPTION	QTY/BOX	QTY/BULK
VW104007	10-24 X 3/4	100	7500
VW104010	10-24 X 1	100	5000
VW104012	10-24 X 1 1/4	100	3500
VW104014	10-24 X 1 7/16	100	3000
VW104015	10-24 X 1 1/2	100	2000
VW124020	12-24 X 2	100	2500
VW124025	12-24 X 2 1/2	100	2000
VW124030	12-24 X 3	100	1500
VW124040	12-24 X 4	100	1000

AUTRES DIMENSIONS DISPONIBLES / OTHER DIMENSIONS ARE AVAILABLE

AUSSI DISPONIBLE / ALSO AVAILABLE

ACIER INOXYDABLE SS 410 STAINLESS STEEL

VIS À TOITURE



ROOFING SCREWS

SUR DEMANDE / ON REQUEST



Tel.: (819) 346-2903 / (888) 345-2903 Fax.: (819) 346-3389

Email: distributeur@boulonsestrie.com

E-39

VIS AUTO-PERÇANTES "TEK"
TÊTE PAN, PRISE CARRÉE
(POUR CHEMINÉE)

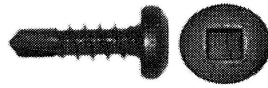

"TEK" SCREWS
PAN HEAD, SQUARE DRIVE
(FOR FIREPLACE)

NOTRE CODE	DESCRIPTION	QTÉ/BTE	QTÉ/VRAC
OUR CODE	DESCRIPTION	QTY/BOX	QTY/BULK
VP188005	8 X 1/2	100	10 000

VIS À PLANCHER DE CAMION
PRISE "TORX"



FLOORBOARD SCREWS
TORX HEAD DRIVE

NOTRE CODE	DESCRIPTION	QTÉ/BTE	QTÉ/VRAC
OUR CODE	DESCRIPTION	QTY/BOX	QTY/BULK
VP425012	1/4 X 1 1/4	100	3000
VP425015	1/4 X 1 1/2	100	2000
VP425020	1/4 X 2	100	1800
VP425025	1/4 X 2 1/2	100	1200
*****	1/4 X 3	100	1000
*****	5/16 X 1 3/4	100	1400
*****	5/16 X 2	100	1200
VP431025	5/16 X 2 1/2	100	800

VIS À PLANCHER DE CAMION
PRISE CARRÉE



FLOORBOARD SCREWS
SQUARE DRIVE

NOTRE CODE	DESCRIPTION	QTÉ/BTE	QTÉ/VRAC
OUR CODE	DESCRIPTION	QTY/BOX	QTY/BULK
VP514015	#14 X 1 1/2	100	3000
VP514020	#14 X 2	100	2000
VP514025	#14 X 2 1/2	100	1500
VP514030	#14 X 3	100	1000
*****	#14 X 4	100	500



Tel.: (819) 346-2903 / (888) 345-2903 Fax.: (819) 346-3389

Email: distributeur@boulonsestrie.com

VIS POUR BOIS TRAITÉ
 À TÊTE PLATE
 ENDUIT DE CÉRAMIQUE



PRESSURE TRHEADED
 FLAT WOOD SCREWS
 CERAMIC COATING

VERT / GREEN
 ANTI-CORROSION

NOTRE CODE	DESCRIPTION	QTÉ/VRAC
OUR CODE	DESCRIPTION	QTY/BULK
VP606022	#6 X 2 1/4	-
*****	#8 X 1 1/4	7000
VP608015	#8 X 1 1/2	6000
VP608017	#8 X 1 3/4	4000
VP608020	#8 X 2	3000
VP608025	#8 X 2 1/2	2500
VP608030	#8 X 3	2000
VP610030	#10 X 3	1500
VP610035	#10 X 3 1/2	1000

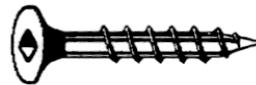

ZINC CHROMATE JAUNE

YELLOW CHROMATE PLATED

JAUNE / YELLOW

NOTRE CODE	DESCRIPTION	QTÉ/VRAC
OUR CODE	DESCRIPTION	QTY/BULK
VP708012	#8 X 1 1/4	7000
VP708015	#8 X 1 1/2	6000
*****	#8 X 1 3/4	4000
VP708020	#8 X 2	3500
VP708025	#8 X 2 1/2	2500
VP708030	#8 X 3	2000
*****	#8 X 3 1/2	1000
VP710020	#10 X 2	-
*****	#10X 3	1500
*****	#10 X 3 1/2	1000
VP710040	#10 X 4	1000



Tel.: (819) 346-2903 / (888) 345-2903 Fax.: (819) 346-3389
 Email: distributeur@boulonsestrie.com

VIS À PLANCHER
PRISE CARRÉE
GROS FILETS
TÊTE TROMPETTE



FLOOR SCREWS
SQUARE DRIVE
COARSE THREAD
BUGGLE HEAD

NOIR / BARE

NOTRE CODE	DESCRIPTION	QTÉ/VRAC
OUR CODE	DESCRIPTION	QTY/BULK
VP508010	#8 X 1	10 000
VP508011	#8 X 1 1/8	10 000
VP508012	#8 X 1 1/4	7 000
VP508015	#8 X 1 1/2	6 000
VP508017	#8 X 1 3/4	4 000
VP508020	#8 X 2	3 500
VP508025	#8 X 2 1/2	2 500
VP508030	#8 X 3	2 000
VP508035	#8 X 3 1/2	1 000
*****	#8 X 4	1 000
VP510025	#10 X 2 1/2	-
*****	#10 X 3	1 500
*****	#10 X 3 1/2	1 000
*****	#10 X 4	1 000

AUSSI DISPONIBLE / ALSO AVAILABLE

VIS À PLANCHER, PRISE CARRÉE,
TÊTE TROMPETTE, FILETS "HIGH-LOW"

FLOOR SCREWS, SQUARE DRIVE,
BUGGLE HEAD, "HIGH-LOW" THREADS

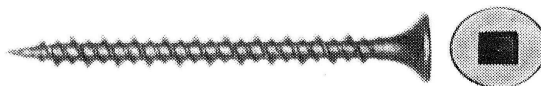

Tel.: (819) 346-2903 / (888) 345-2903 Fax.: (819) 346-3389

Email: distributeur@boulonsestrie.com

VIS À BÉTON
TÊTE PLATE
PRISE CARRÉE

JAUNE / YELLOW

CONCRETE SCREWS
FLAT HEAD
SQUARE DRIVE



NOTRE CODE	DESCRIPTION	QTÉ/BTE
OUR CODE	DESCRIPTION	QTY/BOX
TP518012	3/16 X 1 1/4	100 + 1 MÈCHE / DRILL
TP518017	3/16 X 1 3/4	100 + 1 MÈCHE / DRILL
TP518022	3/16 X 2 1/4	100 + 1 MÈCHE / DRILL
TP518027	3/16 X 2 3/4	100 + 1 MÈCHE / DRILL
TP518032	3/16 X 3 1/4	100 + 1 MÈCHE / DRILL
TP518040	3/16 X 4	100 + 1 MÈCHE / DRILL
TP525012	1/4 X 1 1/4	100 + 1 MÈCHE / DRILL
TP525017	1/4 X 1 3/4	100 + 1 MÈCHE / DRILL
TP525022	1/4 X 2 1/4	100 + 1 MÈCHE / DRILL
TP525027	1/4 X 2 3/4	100 + 1 MÈCHE / DRILL
TP525032	1/4 X 3 1/4	100 + 1 MÈCHE / DRILL
TP525040	1/4 X 4	100 + 1 MÈCHE / DRILL
TP525050	1/4 X 5	100 + 1 MÈCHE / DRILL

JAUNE / YELLOW

VIS À BÉTON
TÊTE HEXAGONALE

CONCRETE SCREWS
HEXAGON HEAD



NOTRE CODE	DESCRIPTION	QTÉ/BTE
OUR CODE	DESCRIPTION	QTY/BOX
TP618012	3/16 X 1 1/4	100 + 1 MÈCHE / DRILL
TP618017	3/16 X 1 3/4	100 + 1 MÈCHE / DRILL
TP618022	3/16 X 2 1/4	100 + 1 MÈCHE / DRILL
TP618027	3/16 X 2 3/4	100 + 1 MÈCHE / DRILL
TP618032	3/16 X 3 1/4	100 + 1 MÈCHE / DRILL
TP625012	1/4 X 1 1/4	100 + 1 MÈCHE / DRILL
TP625017	1/4 X 1 3/4	100 + 1 MÈCHE / DRILL
TP625022	1/4 X 2 1/4	100 + 1 MÈCHE / DRILL
TP625025	1/4 X 2 1/2	100 + 1 MÈCHE / DRILL
TP625027	1/4 X 2 3/4	100 + 1 MÈCHE / DRILL
TP625032	1/4 X 3 1/4	100 + 1 MÈCHE / DRILL
TP625037	1/4 X 3 3/4	100 + 1 MÈCHE / DRILL
TP625040	1/4 X 4	100 + 1 MÈCHE / DRILL

AUSSI DISPONIBLE / ALSO AVAILABLE: *ACIER INOXYDABLE / STAINLESS STEEL*

VIS À BETON
TÊTE HEXAGONALE

BLEU / BLUE

CONCRETE SCREWS
HEXAGON HEAD



NOTRE CODE	DESCRIPTION	QTÉ/BTE
OUR CODE	DESCRIPTION	QTY/BOX
TP118012	3/16 X 1 1/4	100 + MÈCHE / DRILL
TP118017	3/16 X 1 3/4	100 + MÈCHE / DRILL
TP118022	3/16 X 2 1/4	100 + MÈCHE / DRILL
TP118027	3/16 X 2 3/4	100 + MÈCHE / DRILL
TP118032	3/16 X 3 1/4	100 + MÈCHE / DRILL
TP118040	3/16 X 4	100 + MÈCHE / DRILL
TP125012	1/4 X 1 1/4	100 + MÈCHE / DRILL
TP125017	1/4 X 1 3/4	100 + MÈCHE / DRILL
TP125022	1/4 X 2 1/4	100 + MÈCHE / DRILL
TP125027	1/4 X 2 3/4	100 + MÈCHE / DRILL
TP125032	1/4 X 3 1/4	100 + MÈCHE / DRILL
TP125040	1/4 X 4	100 + MÈCHE / DRILL
TP125050	1/4 X 5	100 + MÈCHE / DRILL
TP125060	1/4 X 6	100 + MÈCHE / DRILL

VIS À BÉTON
PRISE ÉTOILE
TÊTE PLATE

BLEU / BLUE

CONCRETE SCREWS
PHILIPS DRIVE
FLAT HEAD



NOTRE CODE	DESCRIPTION	QTÉ/BTE
OUR CODE	DESCRIPTION	QTY/BOX
TP218012	3/16 X 1 1/4	100 + MÈCHE / DRILL
TP218017	3/16 X 1 3/4	100 + MÈCHE / DRILL
TP218022	3/16 X 2 1/4	100 + MÈCHE / DRILL
TP218027	3/16 X 2 3/4	100 + MÈCHE / DRILL
TP218032	3/16 X 3 1/4	100 + MÈCHE / DRILL
TP218040	3/16 X 4	100 + MÈCHE / DRILL
TP225012	1/4 X 1 1/4	100 + MÈCHE / DRILL
TP225017	1/4 X 1 3/4	100 + MÈCHE / DRILL
TP225022	1/4 X 2 1/4	100 + MÈCHE / DRILL
TP225027	1/4 X 2 3/4	100 + MÈCHE / DRILL
TP225032	1/4 X 3 1/4	100 + MÈCHE / DRILL
TP225040	1/4 X 4	100 + MÈCHE / DRILL
TP225050	1/4 X 5	100 + MÈCHE / DRILL
TP225060	1/4 X 6	100 + MÈCHE / DRILL

AUSSI DISPONIBLE / ALSO AVAILABLE: ACIER INOXYDABLE / STAINLESS STEEL



Tel.: (819) 346-2903 / (888) 345-2903 Fax.: (819) 346-3389

Email: distributeur@boulonsestrie.com

E-44

VIS À GYPS
TYPE "S"



DRY WALL SCREWS
TYPE "S"

NOTRE CODE	DESCRIPTION	QTÉ/VRAC
OUR CODE	DESCRIPTION	QTY/BULK
VG106010	#6 X 1	10 000
VG106012	#6 X 1 1/4	8 000
VG106016	#6 X 1 5/8	5 000
VG106020	#6 X 2	3 500
VG106022	#6 X 2 1/4	3 000
VG107016	#7 X 1 5/8	5 000
VG108030	#8 X 3	2 000

VIS À PARTICULE
TÊTE RONDE



PARTICULE BOARD SCREWS
ROUND HEAD

HIGH-LOW

TÊTE PLATE DISPONIBLE / FLAT HEAD IS AVAILABLE

NOTRE CODE	DESCRIPTION	QTÉ/BTE
OUR CODE	DESCRIPTION	QTY/BOX
VN908005	8 X 1/2	100
VN908006	8 X 9/16	100
VN908007	8 X 3/4	100
VN908012	8 X 1 1/4	100
VN908015	8 X 1 1/2	100
VN908017	8 X 1 3/4	100

AUTRES DIMENSIONS DISPONIBLES / OTHER DIMENSIONS ARE AVAILABLE

TÊTE PLATE DISPONIBLE / FLAT HEAD AVAILABLE



Tel.: (819) 346-2903 / (888) 345-2903 Fax.: (819) 346-3389

Email: distributeur@boulonsestrie.com

E-45



NOTRE CODE	DESCRIPTION	QTÉ/BTE
OUR CODE	DESCRIPTION	QTY/BOX
GN018015	3/16 X 1 1/2	100
GN018020	3/16 X 2	100
GN018025	3/16 X 2 1/2	100
GN025020	1/4 X 2	100
GN025025	1/4 X 2 1/2	100
GN031025	5/16 X 2 1/2	100
GN031030	5/16 X 3	100
GN031035	5/16 X 3 1/2	100



NOTRE CODE	DESCRIPTION	QTÉ/BTE
OUR CODE	DESCRIPTION	QTY/BOX
BT010020	10-24 X 2	100
BT010025	10-24 X 2 1/2	100
BT010030	10-24 X 3	100
BT025025	1/4 X 2 1/2	100
BT025020	1/4 X 2	100
BT025030	1/4 X 3	100
BT031017	5/16 X 1 3/4	100
BT031020	5/16 X 2	100
BT031025	5/16 X 2 1/2	100
BT031030	5/16 X 3	100
BT031035	5/16 X 3 1/2	100
BT031040	5/16 X 4	100
BT037020	3/8 X 2	100
BT037025	3/8 X 2 1/2	100
BT037030	3/8 X 3	100
BT037035	3/8 X 3 1/2	100
BT037040	3/8 X 4	100

AUTRES DIMENSIONS DISPONIBLES / OTHER DIMENSIONS AVAILABLE



Tel.: (819) 346-2903 / (888) 345-2903 Fax.: (819) 346-3389

Email: distributeur@boulonsestrie.com

DOUILLES ÉTOILE PHILLIPS BITS	
	
NOTRE CODE	DESCRIPTION
OUR CODE	DESCRIPTION
BT101010	1 X 1
BT101020	1 X 2
BT101027	1 X 2 3/4
BT101040	1 X 4
BT101060	1 X 6
BT102010	2 X 1
BT102020	2 X 2
BT102030	2 X 3
BT102040	2 X 4
BT102060	2 X 6
BT103010	3 X 1
BT103020	3 X 2
BT103030	3 X 3
BT103060	3 X 6

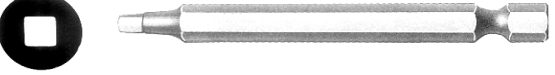
DOUILLES CARRÉES SQUARE BITS	
	
NOTRE CODE	DESCRIPTION
OUR CODE	DESCRIPTION
BT200010	0 X 1
BT200020	0 X 2
BT200030	0 X 3
BT201010	1 X 1
BT201020	1 X 2
BT201030	1 X 3
BT201040	1 X 4
BT201060	1 X 6
BT202010	2 X 1
BT202020	2 X 2
BT202030	2 X 3
BT202040	2 X 4
BT202060	2 X 6
BT203010	3 X 1
BT203020	3 X 2
BT203030	3 X 3
BT203040	3 X 4
BT203060	3 X 6

PRISE MAGNÉTIQUE / MAGNETIC NUTSETTERS

NOTRE CODE	DESCRIPTION
OUR CODE	DESCRIPTION
SM000025	1/4 X 2 9/16
SM000031	5/16 X 2 9/16
SM000037	3/8 X 2 9/16
SM000043	7/16 X 2 9/16

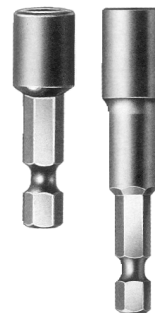

Tel.: (819) 346-2903 / (888) 345-2903 Fax.: (819) 346-3389

Email: distributeur@boulonsestrie.com

TOURNEVIS À PRISE CARRÉE / SCREWDRIVERS SQUARE DRIVE

CODE	DESCRIPTION
TV000000	# 0 Jaune / Yellow
TV000001	# 1 Junior Vert / Green
TV000002	# 2 Junior Rouge / Red
TV000003	# 3 Junior Noir / Black
TV000011	# 1 Jumbo Vert / Green
TV000012	# 2 Jumbo Rouge / Red
TV000013	# 3 Jumbo Noir / Black
TV000014	# 4 X 6 X 10 X 3/4

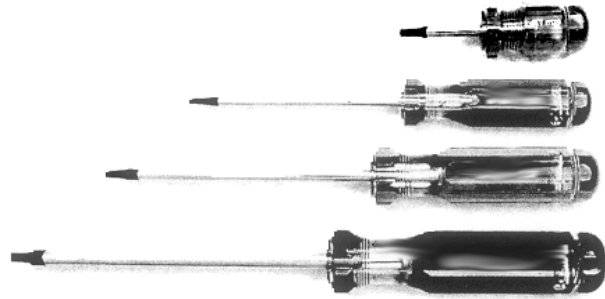

TOURNEVIS PRISE ÉTOILE / SCREWDRIVERS PHILLIPS DRIVE

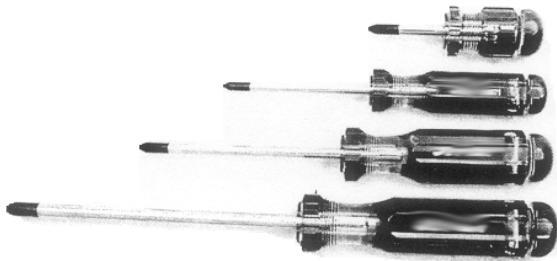

CODE	DESCRIPTION
TV720371	# 0 Jaune / Yellow
TV720372	# 1 Junior Vert / Green
TV720373	# 2 Junior Rouge / Red
*****	# 3 Junior Noir / Black

TOURNEVIS PRISE FENDUE DISPONIBLES / SCREWDRIVERS SLOT DRIVE ARE AVAILABLE

CODE	DESCRIPTION
TV019752	MULTI-DOUILLES / BITS (8) X 6 3/8
TV019758	MULTI-DOUILLES / BITS (12) X 7 1/8













Tel.: (819) 346-2903 / (888) 345-2903 Fax.: (819) 346-3389
 Email: distributeur@boulonsestrie.com

SECTION F

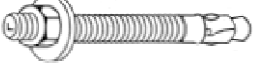

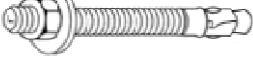





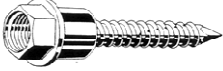

ANCRAGES / ANCHORS

INFORMATION TECHNIQUE.....DÉBUT DE LA SECTION
TECHNICAL INFORMATION.....BEGINNING OF THIS SECTION

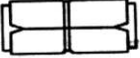
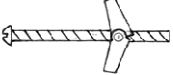
	DESCRIPTION	SECTION-PAGE
	ANCRAGES DE PLASTIQUE, BLEU. PLASTIC ANCHORS, BLUE.	F-5
	ANCRAGES DE PLASTIQUE. PLASTIC ANCHORS.	F-5
	ANCRAGES DE PLASTIQUE, RAWL. PLASTIC ANCHORS, RAWL.	F-5
	ANCRES À IMPACT. DROP IN ANCHORS.	F-3
	ANCRES À IMPACT, HILTI. DROP IN ANCHORS, HILTI.	F-3
	OUTILS POUR ANCRES À IMPACT. DROP IN ANCHOR TOOLS.	F-3
	ANCRAGES À BÉTON. WEDGE ANCHORS.	F-1
	ANCRAGES À BÉTON, SS-304. WEDGE ANCHORS, SS-304.	SUR DEMANDE ON REQUEST
	ANCRAGES À BÉTON WEDGE, HILTI. WEDGE ANCHORS, HILTI.	SUR DEMANDE ON REQUEST
	ANCRES À MAÇONNERIE. SLEEVE ANCHORS.	F-2
	ANCRES À MAÇONNERIE, SS-304. SLEEVE ANCHORS, SS-304.	SUR DEMANDE ON REQUEST

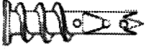





SECTION F

ANCRAGES / ANCHORS

	DESCRIPTION	SECTION-PAGE
	HANGERMATE POUR ACIER. HANGERMATE FOR STEEL.	F-7
	HANGERMATE POUR LE BOIS. HANGERMATE FOR WOOD.	F-7
	HANGERMATE POUR LE BOIS ET LE BÉTON. HANGERMATE FOR WOOD OR CONCRETE.	F-7
	ANCRAGES À SIMPLE EXPANSION. SINGLE EXPANSION SHIELDS.	F-4
	ANCRAGES À DOUBLE EXPANSION. DOUBLE EXPANSION SHIELDS.	F-4
	BOULONS À GENOUILLÈRES À RESSORT, TÊTE RONDE, ZINC. SPRING BOLTS, ROUND HEAD, PLATED.	F-8
	TÊTES DE SCÉLLEMENT À RESSORT SEULEMENT. SPRING HEADS ONLY.	F-8
	ANCRAGES POUR MURS CREUX. EZ ANCHORS.	F-6
	CHEVILLES AVEC CLOU, ZINC. NAIL-IN ANCHORS, PLATED.	F-9
	CHEVILLE AVEC CLOU, ACIER INOXYDABLE. NAIL-IN ANCHORS, STAINLESS STEEL NAIL.	SUR DEMANDE ON REQUEST
	CHEVILLES DE NYLON AVEC CLOU. NYLON NAIL-IN ANCHORS.	F-9
	CHEVILLES AVEC CLOU ZAMAC ZAMAC HAMMER-SCREWS	F-9

SECTION F

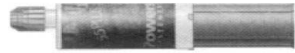
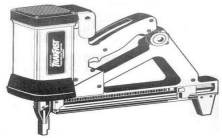
ANCRAGES / ANCHORS

	DESCRIPTION	SECTION-PAGE
	ANCRÉS POUR TIRE-FOND LAG SHIELDS	F-10
	CHEVILLES DE PLOMB LEAD SHIELDS	F-10
	CROCHETS DE FONDATION ANCHOR BOLTS	SUR DEMANDE ON REQUEST
	SYSTÈMES DE FIXATION ADHÉSIFS CONCRETE FASTENING SYSTEMS	 F-11
	SYSTÈMES D'ATTACHES DANS LE BÉTON CONCRETE FASTENING SYSTEMS	 F-12
	CLOUS À CIMENT STRIKER CONCRETE NAILS	F-14

ANCRAGE À BÉTON / WEDGE ANCHOR PERFORMANCE

CONCRETE STRENGTH

ANCHOR DIA	EMBEDMENT DEPTH (D)	2250 PSI		3000 PSI		4000 PSI		5000 PSI	
		ULTIMATE PULLOUT (LBS)	ULTIMATE SHEAR (LBS)	ULTIMATE PULLOUT (LBS)	ULTIMATE SHEAR (LBS)	ULTIMATE PULLOUT (LBS)	ULTIMATE SHEAR (LBS)	ULTIMATE PULLOUT (LBS)	ULTIMATE SHEAR (LBS)
1/4"	1 1/8" min.	2459	1500	2710	1742	3059	2493	3407	3245
	2"	-	-	3304	1829	3766	2618	4228	3407
	2 3/4"	-	-	3898	1916	4473	2743	5048	3569
3/8"	1 5/8" min.	2987	2776	3534	3086	4264	5913	4994	8740
	3"	-	-	4119	3240	5090	6209	6061	9177
	4 1/4"	-	-	4704	3395	5916	6505	7129	9614
1/2"	2 1/4"	6298	6298	6836	6232	7704	10234	8572	14236
	4 1/8"	-	-	7704	3543	8897	10746	10089	14947
	6"	-	-	8572	6855	10089	11257	11607	15659
5/8"	2 7/8"	6965	7724	8007	8233	10307	13005	12608	17776
	5"	-	-	9238	8645	12130	13655	15022	18665
	7"	-	-	10470	9056	13953	14305	17435	19554
3/4"	3 3/8" min.	10114	11157	11338	12138	15405	16728	19472	21317
	5 3/4"	-	-	15309	12745	19460	17564	23610	22383
	8"	-	-	19280	13351	23514	18400	27748	23448
7/8"	4"	-	-	-	-	18750	-	-	-
1"	4 1/2"	-	-	-	-	23000	-	-	-
1 1/4"	5 1/2"	-	-	-	-	35000	-	-	-

F (I-L)



Tel.: (819) 346-2903 / (888) 345-2903 Fax.: (819) 346-3389

Email: distributeur@boulonsestrie.com

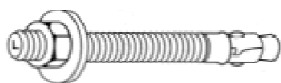

NOTRE CODE	DIA. X LONGUEUR	GRANDEUR DU FORET	LONG. DU FILET	QTÉ/BTE
OUR CODE	DIA. X LENGTH	DRILL DIAMETER	THREAD LENGTH	QTY/BOX
AN625017	1/4 X 1 3/4	1/4	3/4	100
AN625022	1/4 X 2 1/4	1/4	1 1/4	100
AN625032	1/4 X 3 1/4	1/4	2 1/4	100
AN637022	3/8 X 2 1/4	3/8	1 1/8	50
AN637027	3/8 X 2 3/4	3/8	1 1/2	50
AN637030	3/8 X 3	3/8	1 3/4	50
AN637037	3/8 X 3 3/4	3/8	2 1/2	50
AN637050	3/8 X 5	3/8	3 1/2	50
AN637065	3/8 X 6 1/2	3/8	2 3/4	50
AN650027	1/2 X 2 3/4	1/2	1 1/2	100
AN650037	1/2 X 3 3/4	1/2	2 1/4	100
AN650042	1/2 X 4 1/4	1/2	2 3/4	50
AN650055	1/2 X 5 1/2	1/2	3 1/4	25
AN650070	1/2 X 7	1/2	4	25
AN650085	1/2 X 8 1/2	1/2	4	25
AN650100	1/2 X 10	1/2	4	25
AN662035	5/8 X 3 1/2	5/8	1 1/2	20
AN662045	5/8 X 4 1/2	5/8	2 1/2	20
AN662050	5/8 X 5	5/8	3	20
AN662060	5/8 X 6	5/8	4	20
AN662070	5/8 X 7	5/8	4	20
AN662085	5/8 X 8 1/2	5/8	1 1/2	10
AN675042	3/4 X 4 1/4	3/4	2	10
AN675047	3/4 X 4 3/4	3/4	2 1/2	10
AN675055	3/4 X 5 1/2	3/4	3 1/4	10
AN675062	3/4 X 6 1/4	3/4	4	10
AN675070	3/4 X 7	3/4	4	10
AN675085	3/4 X 8 1/2	3/4	1 1/2	10
AN675100	3/4 X 10	3/4	1 1/2	10
AN687060	7/8 X 6	7/8	2 1/4	10
AN687080	7/8 X 8	7/8	2 1/4	10
AN687100	7/8 X 10	7/8	2 1/4	10
AN690060	1 X 6	1	2 1/4	5
AN690090	1 X 9	1	2 1/4	5
AN690120	1 X 12	1	2 1/4	5

AUTRES DIMENSIONS DISPONIBLE / OTHER DIMENSIONS AVAILABLE
 AUSSI DISPONIBLE / ALSO AVAILABLE : SS304 - SS316

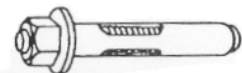

NOTRE CODE	DIA. X LONGUEUR	GRANDEUR DU FORET	PROFONDEUR MIN	QTÉ/BTE
OUR CODE	DIA. X LENGTH	DRILL DIAMETER	MINIMUM DEEP	QTY/BOX
AN531015	5/16 X 1 1/2	5/16	1 1/2	100
AN531025	5/16 X 2 1/2	5/16	1 1/2	100
AN537018	3/8 X 1 7/8	3/8	1 7/8	50
AN537030	3/8 X 3	3/8	1 7/8	50
AN537040	3/8 X 4	3/8	1 7/8	25
AN550022	1/2 X 2 1/4	1/2	2 1/4	25
AN550030	1/2 X 3	1/2	2 1/4	25
AN550040	1/2 X 4	1/2	2 1/4	25
AN550060	1/2 X 6	1/2	2 1/4	15
AN562022	5/8 X 2 1/4	5/8	2 1/4	25
AN562042	5/8 X 4 1/4	5/8	2 1/4	10
AN562060	5/8 X 6	5/8	2 1/4	10
AN575025	3/4 X 2 1/2	3/4	3 3/8	10
AN575042	3/4 X 4 1/4	3/4	3 3/8	5
AN575062	3/4 X 6 1/4	3/4	3 3/8	5

AUTRES DIMENSIONS DISPONIBLE / OTHER DIMENSIONS AVAILABLE
AUSSI DISPONIBLE / ALSO AVAILABLE : *SS304*

TYPES DISPONIBLES / AVAILABLE TYPES

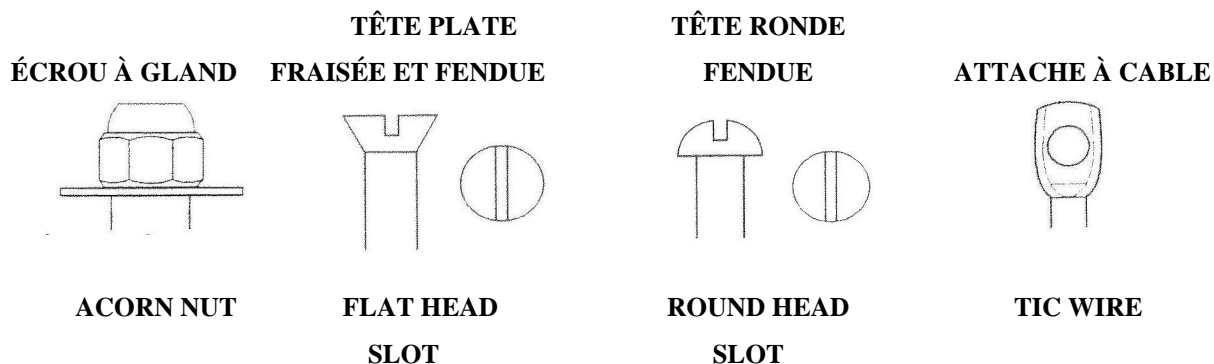

ANCRES À IMPACT
" DROP IN "



DROP IN
ANCHORS

NOTRE CODE	DESCRIPTION	GRANDEUR DU FORET	QTÉ/BTE
OUR CODE	DESCRIPTION	DRILL DIAMETER	QTY/BOX
AN200025	1/4-20	3/8	100
AN200037	3/8-16	1/2	50
AN200050	1/2-13	5/8	50
AN200062	5/8-11	7/8	25
AN200075	3/4-10	1	25

AUSSI DISPONIBLE / ALSO AVAILABLE : SS304

ANCRES À IMPACT
" DROP IN "



DROP IN
ANCHORS

HILTI

NOTRE CODE	DESCRIPTION	QTÉ/BTE
OUR CODE	DESCRIPTION	QTY/BOX
AN300025	1/4	100
AN300037	3/8	50
AN300050	1/2	50

OUTILS POUR ANCRES
À IMPACT



DROP IN
ANCHOR TOOLS

NOTRE CODE	DESCRIPTION	QTÉ/BTE
OUR CODE	DESCRIPTION	QTY/BOX
AN210250	1/4	1
AN210375	3/8	1
AN210500	1/2	1
AN210625	5/8	1
AN210750	3/4	1



Tel.: (819) 346-2903 / (888) 345-2903 Fax.: (819) 346-3389
Email: distributeur@boulonstrie.com

ANCRAGES
À SIMPLE
EXPANSION

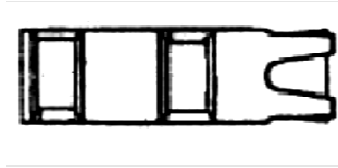

SINGLE
EXPANSION
SHIELDS

NOTRE CODE	DESCRIPTION	GRANDEUR DU FORET	QTÉ/BTE
OUR CODE	DESCRIPTION	DRILL DIAMETER	QTY/BOX
AS100250	1/4 X 1 5/16	1/2	50
AS100315	5/16 X 1 1/2	5/8	50
AS100375	3/8 X 1 1/2	5/8	50
AS100500	1/2 X 2 1/16	7/8	25
AS100625	5/8 X 2 5/8	1	20
AS100750	3/4 X 2 3/4	1 1/4	10

ANCRAGES
À DOUBLE
EXPANSION

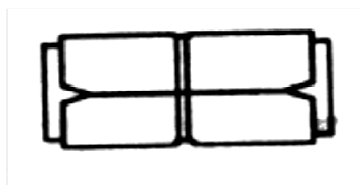

DOUBLE
EXPANSION
SHIELDS

NOTRE CODE	DESCRIPTION	GRANDEUR DU FORET	QTÉ/BTE
OUR CODE	DESCRIPTION	DRILL DIAMETER	QTY/BOX
AS200250	1/4 X 1 5/16	1/2	50
AS200315	5/16 X 1 1/2	5/8	50
AS200375	3/8 X 1 1/2	3/4	50
AS200500	1/2 X 2 1/16	7/8	25
AS200625	5/8 X 2 5/8	1	20
AS200750	3/4 X 2 3/4	1 1/4	10



Tel.: (819) 346-2903 / (888) 345-2903 Fax.: (819) 346-3389
Email: distributeur@boulonstrie.com

ANCRAGES DE PLASTIQUE



PLASTIC ANCHORS

BLEU / BLUE

NOTRE CODE	DIA. X LONGUEUR	QTÉ/BTE
OUR CODE	DIA. X LENGTH	QTY/BOX
AN000006	6-8 X 3/4	100
AN000008	8-10 X 7/8	100
AN000010	10-12 X 1	100
AN000014	14-16 X 1 1/2	100

CHEVILLES DE PLASTIQUE



PLASTIC ANCHORS

NOTRE CODE	DIA. X LONGUEUR	QTÉ/BTE
OUR CODE	DIA. X LENGTH	QTY/BOX
AN000187	3/16 X 1	100
AN000250	1/4 X 1 1/4	100
AN000315	5/16 X 1 1/2	100

ANCRAGES DE PLASTIQUE



PLASTIC ANCHORS

RAWL

RAWL

NOTRE CODE	DIA. X LONGUEUR	QTÉ/BTE
OUR CODE	DIA. X LENGTH	QTY/BOX
AN100010	10-12 X 1	100
AN100012	10-12 X 1 1/4	100
AN100015	10-12 X 1 1/2	100
AN101410	14 X 1	100
AN101415	14 X 1 1/2	100



Tel.: (819) 346-2903 / (888) 345-2903 Fax.: (819) 346-3389

Email: distributeur@boulonsestrie.com

**ANCRAGES POUR MURS CREUX
VISSE SANS PERÇAGE**

**EZ ANCHORS SELF DRILLING
FOR WALLBOARD**

POUR MUR ÉPAISSEUR 5/8
AVEC UNE VIS # 8

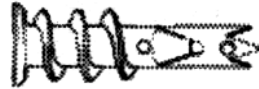

UP TO 5/8 DRYWALL FOR USE
WITH # 8 SCREWS

NOTRE CODE	DESCRIPTION	QTÉ/BTE
OUR CODE	DESCRIPTION	QTY/BOX
EZ000002	ZINC/PLATED	100

POUR MUR ÉPAISSEUR 5/8
AVEC UNE VIS # 8

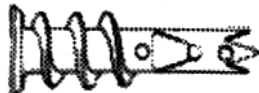

UP TO 5/8 DRYWALL FOR USE
WITH # 8 SCREWS

LARGE NOTRE CODE	WHITE NYLON DESCRIPTION	LARGE QTÉ/BTE
OUR CODE	DESCRIPTION	QTY/BOX
EZ000003	PLASTIQUE/PLASTIC	100

UTILISER AVEC UNE VIS # 6

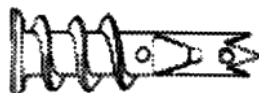

FOR USE WITH # 6 SCREWS

PETIT NOTRE CODE	WHITE NYLON DESCRIPTION	PETIT QTÉ/BTE
OUR CODE	DESCRIPTION	QTY/BOX
EZ000001	PLASTIQUE/PLASTIC	100



Tel.: (819) 346-2903 / (888) 345-2903 Fax.: (819) 346-3389
Email: distributeur@boulonsestrie.com

ANCRAGES
AUTO-PERÇANTS

HANGERMATE

SELF-DRILLING
ANCHORS

HANGERMATE POUR
L'ACIER

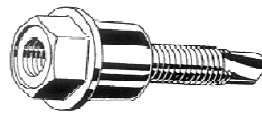

HANGERMATE
FOR STEEL

NOTRE CODE	DESCRIPTION	QTÉ/BTE
OUR CODE	DESCRIPTION	QTY/BOX
HM250001	1/4-20 (FOR .060-.250) 1/4-20 X 1"	100
HM375001	3/8-16 (FOR .060-.250) 5/16-24 X 1 1/8"	100
*****	3/8-16 (FOR .060-.250) 1/4-20 X 1"	100

HANGERMATE
POUR LE BOIS



HANGERMATE
FOR WOOD

NOTRE CODE	DESCRIPTION	QTÉ/BTE
OUR CODE	DESCRIPTION	QTY/BOX
HM375003	3/8-16 (BOIS) 5/16 X 2 1/4"	100

HANGERMATE
POUR LE BOIS



HANGERMATE
FOR WOOD

NOTRE CODE	DESCRIPTION	QTÉ/BTE
OUR CODE	DESCRIPTION	QTY/BOX
HM250002	1/4-20 (5/16 X 2 1/4)	100

HANGERMATE POUR
LE BÉTON

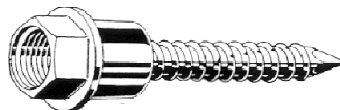

HANGERMATE FOR
CONCRETE

NOTRE CODE	DESCRIPTION	QTÉ/BTE
OUR CODE	DESCRIPTION	QTY/BOX
HM375002	3/8-16 (BÉTON) 5/16 X 2 1/4"	100

L'ADAPTEUR POUR HANGERMATE EST DISPONIBLE / HANGERMATE ADAPTOR IS AVAILABLE



Tel.: (819) 346-2903 / (888) 345-2903 Fax.: (819) 346-3389

Email: distributeur@boulonstrie.com

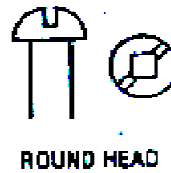
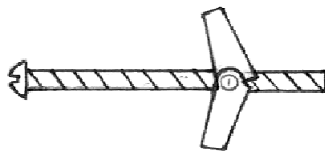

ROUND HEAD

NOTRE CODE	DESCRIPTION	QTÉ/BTE
OUR CODE	DESCRIPTION	QTY/BTE
TB012020	1/8 X 2	50
TB012030	1/8 X 3	50
TB012040	1/8 X 4	50
TB018020	3/16 X 2	50
TB018030	3/16 X 3	50
TB018040	3/16 X 4	50
TB018060	3/16 X 6	50
TB025030	1/4 X 3	50
TB025040	1/4 X 4	50
TB025050	1/4 X 5	50
TB025060	1/4 X 6	50
TB031030	5/16 X 3	25
TB031040	5/16 X 4	25
TB037030	3/8 X 3	25
TB037040	3/8 X 4	25

TÊTES DE SCÈLEMENT
À RESSORT SEULEMENT



SPRING HEADS ONLY

NOTRE CODE	DESCRIPTION	QTÉ/BTE
OUR CODE	DESCRIPTION	QTY/BTE
TH000187	3/16	100
TH000250	1/4	100
TH000312	5/16	50
TH000375	3/8	25

AUTRES DIMENSIONS DISPONIBLES/OTHER DIMENSIONS ARE AVAILABLE



Tel.: (819) 346-2903 / (888) 345-2903 Fax.: (819) 346-3389

Email: distributeur@boulonstrie.com

CHEVILLES AVEC CLOU
ZINC



NAIL IN ANCHORS
PLATED

NOTRE CODE	DESCRIPTION	GRANDEUR DU FORET	PROFONDEUR MINIMUM	QTÉ/BTE
OUR CODE	DESCRIPTION	DRILL DIAMETER	MINIMUM DEEP	QTY/BOX
NI118008	3/16 X 7/8	3/16	5/8	100
*****	1/4 X 3/4	1/4	5/8	100
NI125010	1/4 X 1	1/4	3/4	100
NI125012	1/4 X 1 1/4	1/4	3/4	100
NI125015	1/4 X 1 1/2	1/4	3/4	100
NI125020	1/4 X 2	1/4	3/4	100

CHEVILLES DE NYLON
AVEC CLOU

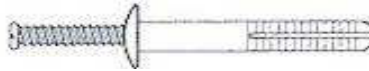

NYLON
NAIL IN ANCHORS

NOTRE CODE	DESCRIPTION	GRANDEUR DU FORET	PROFONDEUR MINIMUM	QTÉ/BTE
OUR CODE	DESCRIPTION	DRILL DIAMETER	MINIMUM DEEP	QTY/BOX
NI218010	3/16 X 1	3/16	5/8	100
NI225007	1/4 X 3/4	1/4	3/4	100
NI225010	1/4 X 1	1/4	3/4	100
NI225015	1/4 X 1 1/2	1/4	3/4	100
NI225020	1/4 X 2	1/4	3/4	100
NI225030	1/4 X 3	1/4	3/4	100
NI225040	1/4 X 4	1/4	3/4	50

AUSSI DISPONIBLE / ALSO AVAILABLE

CHEVILLES AVEC CLOU
EN ACIER INOXYDABLE



NAIL IN ANCHORS
STAINLESS STEEL NAILS



CHEVILLES AVEC CLOU ZAMAC

ZAMAC HAMMER-SCREWS



Tel.: (819) 346-2903 / (888) 345-2903 Fax.: (819) 346-3389

Email: distributeur@boulonstrie.com

ANCRES POUR TIRE-FONDS
COURT



LAG SCREW SHIELDS
SHORT

NOTRE CODE	DESCRIPTION	GRANDEUR DU FORET	LONG. DE L'ANCRAGE	QTÉ/BTE
OUR CODE	DESCRIPTION	DRILL DIAMETER	ANCHOR LENGTH	QTY/BOX
LS300250	1/4 COURT/SHORT	1/2	1	50
LS300315	5/16 COURT/SHORT	1/2	1 1/4	50
LS300375	3/8 COURT/SHORT	5/8	1 3/4	50
LS300500	1/2 COURT/SHORT	3/4	2	50

ANCRES POUR TIRE-FONDS
LONG

LAG SCREW SHIELDS
LONG

NOTRE CODE	DESCRIPTION	GRANDEUR DU FORET	LONG. DE L'ANCRAGE	QTÉ/BTE
OUR CODE	DESCRIPTION	DRILL DIAMETER	ANCHOR LENGTH	QTY/BOX
LS400250	1/4 LONG	1/2	1 1/2	50
LS400315	5/16 LONG	1/2	1 3/4	50
LS400375	3/8 LONG	5/8	2 1/2	50
LS400500	1/2 LONG	3/4	3	25

CHEVILLES DE PLOMB



LEAD SHIELDS

NOTRE CODE	DESCRIPTION	GRANDEUR DU FORET	QTÉ/BTE
OUR CODE	DESCRIPTION	DRILL DIAMETER	QTY/BOX
LS568007	6-8 X 3/4	1/4	100
LS568010	6-8 X 1	1/4	100
LS568015	6-8 X 1 1/2	1/4	100
LS512007	10-12-14 X 3/4	5/16	100
LS512010	10-12-14 X 1	5/16	100
LS512015	10-12-14 X 1 1/2	5/16	100
LS516010	16-18 X 1	3/8	100
LS516015	16-18 X 1 1/2	3/8	100



Tel.: (819) 346-2903 / (888) 345-2903 Fax.: (819) 346-3389
Email: distributeur@boulonstrie.com

**OUTILS POUR CARTOUCHES,
CARTOUCHES DE COLLE
& EMBOUTS**

**CARTRIDGE TOOLS,
NOZZLES &
EPOXY CARTRIDGES**

NOTRE CODE	DESCRIPTION
OUR CODE	DESCRIPTION
EP008461	POUR CARTOUCHES / FOR CARTRIDGE 5.5 OZ.
EP008462	TUBE DE 5.5 OZ AVEC UN EMBOUT & UN PRESOIR / 5.5 OZ TUBE WITH ONE NOZZLE & ONE PUSHER
EP008482	EMBOUT DE PLASTIQUE POUR 5.5 OZ / NOZZLE FOR 5.5 OZ CARTRIDGE

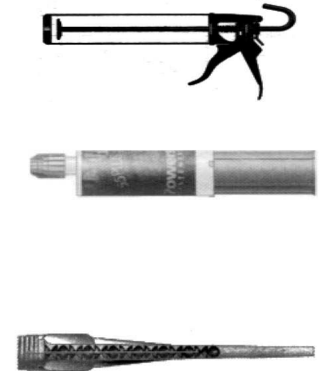

NOTRE CODE	DESCRIPTION
OUR CODE	DESCRIPTION
EP009000	POUR CARTOUCHES 6.0 OZ / FOR CARTRIDGE 6.0 OZ
EP009010	TUBE C6 (18 OZ) / C6 (18 OZ) CARTRIDGE
EP009020	EMBOUT DE PLASTIQUE POUR 18 OZ / NOZZLE FOR 18 OZ CARTRIDGE



ACCESSOIRES / ACCESSORIES

BROSSES / METAL BRUSHES



AUSSI DISPONIBLE / ALSO AVAILABLE

PRODUITS CHIMIQUES



**Tel.: (819) 346-2903 / (888) 345-2903 Fax.: (819) 346-3389
Email: distributeur@boulonsestrie.com**

**SYSTÈMES D'ATTACHES
DANS LE BÉTON**

CONCRETE FASTENING SYSTEMS



D60



D45

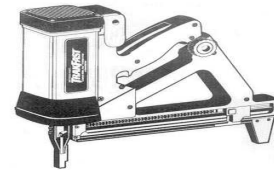

TF 1100

CHARGE SIMPLE

SINGLE CRIMP LOAD

POUR / FOR : 721 , M70...

NOTRE CODE	DESCRIPTION
OUR CODE	DESCRIPTION
*****	GRIS / GRAY .22
PL100022	BRUN / BROWN .22
PL100032	VERT / GREEN .22
*****	JAUNE / YELLOW



CHARGE EN DISQUE

DISC LOAD

POUR / FOR : D60, D200, D45, AUTOFAST.

NOTRE CODE	DESCRIPTION
OUR CODE	DESCRIPTION
*****	BRUN / BROWN .25
PL100022	VERT / GREEN .25
PL204811	JAUNE / YELLOW .25
PL204812	ROUGE / RED .25



CHARGE EN BANDE

LOAD SAVER STRIP

**POUR / FOR: TS750P, SA270, COBRA III, DX351, DX A40,
DX A41, DX 350, DX 36...**

NOTRE CODE	DESCRIPTION
OUR CODE	DESCRIPTION
*****	VERT / GREEN .27
PL204800	JAUNE / YELLOW .27
PL204805	ROUGE / RED .27
*****	MAUVE / PURPLE .27



Tel.: (819) 346-2903 / (888) 345-2903 Fax.: (819) 346-3389

Email: distributeur@boulonstrie.com

CLOUS RAMSET .300 DIA. TÊTE

.300 HEADED TRACK PINS

POUR / FOR: AUTOFAST, DX35, DX36, DX350, DXA40,
DXA41, MODEL 721, TS750P, SA270, D60, D45, MODEL 70, COBRA III ...

NOTRE CODE	DESCRIPTION
OUR CODE	DESCRIPTION
PL503007	3/4"
PL503011	1"
PL503013	1 1/4"

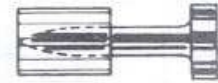

CLOUS RAMSET .300 DIA. TÊTE

.300 HEADED DRIVE PINS

POUR / FOR: AUTOFAST, DX35, DX36, DX350, DXA40,
DXA41, MODEL 721, TS750P, SA270, D60, D45, MODEL 70, COBRA III ...

NOTRE CODE	DESCRIPTION
OUR CODE	DESCRIPTION
*****	1/2" KNURLED
*****	3/4"
*****	1"
*****	1 1/4"
PL503015	1 1/2"
*****	1 3/4"
PL503021	2"
*****	2 3/8"
PL503032	2 1/2"
PL503030	3"

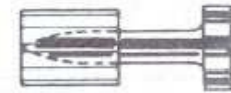

CLOUS 6 mm DIA. TÊTE
AVEC RONDELLE M12

6 mm HEADED DRIVE PINS
WITH 12 mm WASHER

POUR / FOR: MODEL DX400, DX450

NOTRE CODE	DESCRIPTION
OUR CODE	DESCRIPTION
PL503010	1"
*****	1 1/4"
PL503016	1 1/2"
PL503020	2"
PL503026	2 1/2"
PL503031	3 "





NOTRE CODE	DESCRIPTION	FINISH	QTÉ/BTE
OUR CODE	DESCRIPTION	FINISH	QTY/BOX
*****	1 1/8"	H.D.G.	100
*****	1 1/2"	H.D.G.	100
CB00002	2"	H.D.G.	100
*****	2 1/2"	H.D.G.	100
CB00003	3"	H.D.G.	100
*****	3 1/2"	H.D.G.	100
CB00004	4"	H.D.G.	100
CB00005	4 1/2"	H.D.G.	100

CHARTE DE PERFORMANCE / STRIKER PERFORMANCE CHART

PULLOUT VALUES IN CONCRETE (3000 psi, cured 40 days)

EMBEDMENT (IN)	1"	1 1/2"	2"
PULLOUT VALUE (LBS)	1100	1500	1940



Tel.: (819) 346-2903 / (888) 345-2903 Fax.: (819) 346-3389

Email: distributeur@boulonsestrie.com

SECTION G









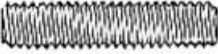
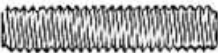
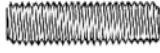

TIGES ET GOUPILLES / RODS ET PINS

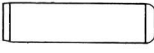
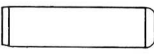
INFORMATION TECHNIQUE.....DÉBUT DE LA SECTION
 TECHNICAL INFORMATION.....BEGINNING OF THIS SECTION

	DESCRIPTION	SECTION-PAGE
	TIGES FILETÉES, <i>GROS FILETS</i> , ACIER C1010, 3' (36"), NOIR & ZINC. THREADED RODS, <i>NATIONAL COARSE</i> , STEEL C1010, 3'(36"), BARE & PLATED.	G-1
	TIGES FILETÉES, <i>GROS FILETS</i> , ACIER C1010, 10' (120"), NOIR & ZINC. THREADED RODS, <i>NATIONAL COARSE</i> , STEEL C1010, 10'(120"), BARE & PLATED.	G-1
	TIGES FILETÉES, <i>FILETS FINS</i> , ACIER C1010, 3' (36"), NOIR. THREADED RODS, <i>NATIONAL FINE</i> , STEEL C1010, 3'(36"), BARE.	G-2
	TIGES FILETÉES ALLOY, <i>GROS FILETS & FILETS FINS</i> , 3' (36"). ALLOY THREADED RODS, <i>NATIONAL COARSE & FINE</i> , 3'(36").	G3
	TIGES FILETÉES ALLOY, <i>GROS FILETS</i> , ACIER B7, 12' (144"), NOIR. ALLOY THREADED RODS, <i>NATIONAL COARSE</i> , STEEL B7, 12'(144"), PLAIN.	G-3
	TIGES FILETÉES, <i>FILETS À GAUCHE</i> , 3'(36"). THREADED RODS, <i>LEFT HAND</i> , 3' (36").	G-2
	TIGES FILETÉES, <i>FILETS À GAUCHE</i> , 10'(120"). THREADED RODS, <i>LEFT HAND</i> , 10' (120").	SUR DEMANDE ON REQUEST
	TIGES FILETÉES, "ACME", 3' (36") & 12'(144") C1018. "ACME" THREADED RODS, 3' (36") & 12'(144") C1018.	G-4
	TIGES FILETÉES, <i>GROS FILETS</i> , SS-304, 3'(36"). THREADED RODS, SS-304, <i>NATIONAL COARSE</i> , 3'(36").	G-5
	TIGES FILETÉES, <i>GROS FILETS</i> , SS-304, 12'(120"). THREADED RODS, <i>NATIONAL COARSE</i> , SS-304, 12'(120").	G-5
	TIGES FILETÉES, <i>GROS FILETS</i> , SS-316, 3'(36"). THREADED RODS, <i>NATIONAL COARSE</i> , SS-316, 3'(36").	G-5
	TIGES FILETÉES, <i>FILETS FINS</i> , SS-304, 3' (36") & 12' (120"). THREADED RODS, <i>NATIONAL FINE</i> , SS-304, 3' (36") & 12' (120").	SUR DEMANDE ON REQUEST
	TIGES FILETÉES, <i>FILETS FINS</i> , SS-316, 3'(36"). THREADED RODS, <i>NATIONAL FINE</i> , SS-316, 3'(36").	SUR DEMANDE ON REQUEST

SECTION G

TIGES ET GOUPILLES / RODS ET PINS

	DESCRIPTION	SECTION-PAGE
	TIGES FILETÉES, <i>MÉTRIQUE</i> , DIN 975, CLASSE 4,6, NOIR & ZINC. THREADED RODS, <i>METRIC</i> , DIN 975, CLASS 4.6, BARE & PLATED.	G-6
	TIGES FILETÉES, GALVANISÉES À CHAUD. THREADED RODS, H.D.G.	SUR DEMANDE ON REQUEST
	GOUGEONS FILETÉS, MATÉRIEL B-7. THREADED STUDS, B-7 MATERIAL.	SUR DEMANDE ON REQUEST
	ACIER EN RONDIN, W-1, 3' (36"). DRILL RODS, W-1, 3' (36").	G-7
	ACIER EN RONDIN, W-1, 3' (36"), SS-304. DRILL RODS, W-1, 3' (36"), SS-304.	SUR DEMANDE ON REQUEST
	GOUPILLES CYLINDRIQUES, ACIER ALLOY. ALLOY STEEL DOWEL PINS.	G-8
	GOUPILLES CYLINDRIQUES, <i>MÉTRIQUE</i> . METRIC DOWEL PINS.	SUR DEMANDE ON REQUEST
	GOUPILLES FENDUES, NOIR. COTTER PINS, BARE.	SUR DEMANDE ON REQUEST
	GOUPILLES FENDUES, ZINC. COTTER PINS, PLATED.	G-9
	GOUPILLES FENDUES, SS-304. COTTER PINS, SS-304.	SUR DEMANDE ON REQUEST
	GOUPILLES FENDUES À RESSORT, NOIR. SPRING TENSION PINS, BARE.	G-10
	GOUPILLES FENDUES À RESSORT, ZINC. SPRING TENSION PINS, PLATED.	SUR DEMANDE ON REQUEST
	GOUPILLES FENDUES À RESSORT, <i>MÉTRIQUE</i> . SPRING TENSION PINS, <i>METRIC</i> .	SUR DEMANDE ON REQUEST
	GOUPILLES FENDUES À RESSORT, SS-420. SPRING TENSION PINS, SS-420.	SUR DEMANDE ON REQUEST

SECTION G

TIGES ET GOUPILLES / RODS ET PINS

	DESCRIPTION	SECTION-PAGE
	GOUPILLES CONIQUES. TAPER PINS.	G-12
	GOUPILLES CONIQUES FILETÉES. THREADED TAPER PINS.	SUR DEMANDE ON REQUEST
	GOUPILLES CONIQUES FILETÉES, ACIER INOXYDABLE. THREADED TAPER PINS, STAINLESS STEEL.	SUR DEMANDE ON REQUEST
	GOUPILLES CONIQUES, MÉTRIQUE. TAPER PINS, METRIC.	SUR DEMANDE ON REQUEST
	GOUPILLES CONIQUES, ACIER INOXYDABLE. THREADED TAPER PINS, STAINLESS STEEL.	SUR DEMANDE ON REQUEST
	AGRAFES POUR GOUPILLES D'ATTELAGE, ZINC. HICHT PINS, PLATED.	G-14
	GOUPILLES JOUG UNIVERSEL. UNIVERSAL CLEVIS PINS.	G-16
	GOUPILLES JOUG. CLEVIS PINS.	G-16
	CLAVETTES DEMI-LUNE. WOODRUFF KEYS.	G-17
	BARRES À CLÉ CARRÉES, 12". KEY STOCK SQUARE, 12".	G-19
	BARRES À CLÉ CARRÉES, 144". KEY STOCK SQUARE, 144".	G-19
	BARRES À CLÉ RECTANGULAIRES, 12". KEY STOCK RECTANGULAR, 12".	SUR DEMANDE ON REQUEST

TIGES FILETÉES
GROS FILETS
SPEC A-307
C1010

L = 3' OU 36''
MINIMUM TENSILE
STRENGTH : 50 000 TO 60 000 psi

THREADED RODS
NATIONAL COARSE
SPEC A-307
C1010

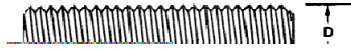

NOIR / BARE

ZINC / PLATED

NOTRE CODE	DIA. (D) X LONG (L)	NOTRE CODE	DIA. (D) X LONG (L)
OUR CODE	DIA. (D) X LENGTH (L)	OUR CODE	DIA. (D) X LENGTH (L)

TIGES FILETÉES
FILETS FINS

SPEC A-307
MINIMUM TENSILE STRENGTH:
50 000 TO 60 000 psi
C1010
L = 3' OU 36 "

THREADED RODS
NATIONAL FINE

NOIR / BARE

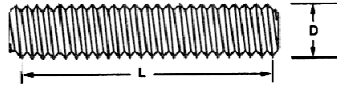

NOTRE CODE	DIA. (D) X LONG (L)
OUR CODE	DIA. (D) X LENGTH (L)
TG300250	1/4-28 X 3'
TG300315	5/16-24 X 3'
TG300375	3/8-24 X 3'
TG300437	7/16-20 X 3'
TG300500	1/2-20 X 3'
TG300625	5/8-18 X 3'
TG300750	3/4-16 X 3'
TG300875	7/8-14 X 3'
TG301000	1-14 X 3'
TG301012	1-12 X 3' (SPECIAL)
TG301125	1 1/8-12 X 3'
TG301250	1 1/4-12 X 3'
TG301500	1 1/2-12 X 3'

AUSSI DISPONIBLE / ALSO AVAILABLE :

LONGUEUR DE 12' (144")	ZINC / PLATED
------------------------	---------------

L = 3' OU 36 "

TIGES FILETÉES
FILETS À GAUCHE

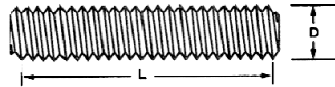

THREADED RODS
LEFT HAND

NF DISPONIBLE SUR DEMANDE / NF AVAILABLE ON REQUEST

NOTRE CODE	DIA. (D) X LONG (L)
OUR CODE	DIA. (D) X LENGTH (L)
TG500315	5/16-18 X 3'
TG500375	3/8-16 X 3'
TG500500	1/2-13 X 3'
TG500625	5/8-11 X 3'
TG500750	3/4-10 X 3'
TG501001	1-8 X 3'

AUSSI DISPONIBLE / ALSO AVAILABLE :

LONGUEUR DE 12' (120")	ZINC / PLATED
------------------------	---------------

TIGES FILETÉES ACIER B-7
PLAQUÉ ZINC
JAUNE DICHROMATE

U.N.C. / U.N.F.

L = 3' OU 36 ''

ALLOY THREADED RODS
YELLOW ZINC
DICHROMATE FINISH



U.N.C.

U.N.F.



TIGES FILETÉES "ACME"
ACIER NOIR

ACIER / STEEL
C1018
29° ACME THREAD

"ACME" THREADED RODS
BARE FINISH

L= 3' OU 36"



NOTRE CODE	DIA. (D) X LONG (L)
OUR CODE	DIA. (D) X LENGTH (L)
*****	3/8-12 X 3'
TG700500	1/2-10 X 3'
TG700625	5/8-8 X 3'
TG700750	3/4-6 X 3'
TG700875	7/8-6 X 3'
TG701000	1-5 X 3'
*****	1 1/8-5 X 3'
TG701250	1 1/4-5 X 3'
TG701500	1 1/2-4 X 3'
*****	2-4 X 3'

L= 12' OU 144"

TIGES FILETÉES
L = 3' OU 36"

SS304 & SS316

THREADED RODS
L = 3' OR 36"

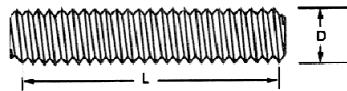

<i>SS-304 / 18-8</i>		<i>SS-316</i>	
NOTRE CODE	DIA. (D) X LONG (L)	NOTRE CODE	DIA. (D) X LONG (L)
OUR CODE	DIA. (D) X LENGTH (L)	OUR CODE	DIA. (D) X LENGTH (L)
TF600111	10-32 X 3'		
TF600250	1/4-20 X 3'	TF610250	1/4-20 X 3'
TF600315	5/16-18 X 3'	TF610315	5/16-18 X 3'
TF600375	3/8-16 X 3'	TF610375	3/8-16 X 3'
TF600437	7/16-14 X 3'	TF610437	7/16-14 X 3'
TF600500	1/2-13 X 3'	TF610500	1/2-13 X 3'
TF600625	5/8-11 X 3'	TF610625	5/8-11 X 3'
TF600750	3/4-10 X 3'	TF610750	3/4-10 X 3'
TF600875	7/8-9 X 3'	TF610875	7/8-9 X 3'
TF601000	1-8 X 3'	TF611000	1-8 X 3'
TF601125	1 1/8-7 X 3'		

AUTRES DIMENSIONS DISPONIBLES / OTHER DIMENSIONS ARE AVAILABLE

TIGES FILETÉES
L = 12' OR 144"

SS304

THREADED RODS
L = 12' OR 144"

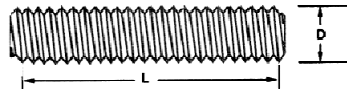

<i>SS-304 / 18-8</i>	
NOTRE CODE	DIA. (D) X LONG (L)
OUR CODE	DIA. (D) X LENGTH (L)
TF530250	1/4-20 X 12'
TF530315	5/16-18 X 12'
TF530375	3/8-16 X 12'
TF530500	1/2-13 X 12'
TF530625	5/8-11 X 12'
TF530750	3/4-10 X 12'
TF530875	7/8-9 X 12'
TF531000	1-8 X 12'
TF531125	1 1/8-7 X 12'
TF531250	1 1/4-7 X 12'
TF531500	1 1/2-6 X 12'

AUTRES LONGUEURS ET AUTRES DIMENSIONS DISPONIBLES /
OTHER DIMENSIONS AND OTHER LENGTHS ARE AVAILABLE

FILETS FINS DISPONIBLES / FINE THREADS AVAILABLE
12' (144") : DISPONIBLE / AVAILABLE SS316



Tel.: (819) 346-2903 / (888) 345-2903 Fax.: (819) 346-3389

Email: distributeur@boulonstrie.com

TIGES FILETÉES
MÉTRIQUE
DIN 975 CLASS 4.6

NOIR / BARE
ZINC / PLATED
1 MÈTRE / 1 METER

THREADED RODS
METRIC
DIN 975 CLASS 4.6

GROS FILETS

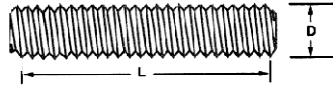

NATIONAL COARSE

NOTRE CODE NOIR	NOTRE CODE ZINC	DIA. (D) X LONG (L)
OUR CODE BARE	OUR CODE PLATED	DIA. (D) X LENGTH (L)
*****	*****	M2 X .40 X 1M
TF700003	*****	M3 X .50 X 1M
*****	*****	M4 X .70 X 1M
TF700005	TF705005	M5 X .80 X 1M
TF700006	*****	M6 X 1.00 X 1M
*****	*****	M7 X 1.00 X 1M
TF700008	TF708010	M8 X 1.25 X 1M
TF700010	TF710010	M10 X 1.50 X 1M
TF700012	TF712012	M12 X 1.75 X 1M
TF700014	*****	M14 X 2.00 X 1M
TF700016	TF716016	M16 X 2.00 X 1M
TF700018	*****	M18 X 2.50 X 1M
TF700020	TF720020	M20 X 2.50 X 1M
*****	*****	M22 X 2.50 X 1M
TF700024	TF724024	M24 X 3.00 X 1M
*****	*****	M27 X 3.00 X 1M
*****	TF730030	M30 X 3.50 X 1M

AUTRES DIMENSIONS DISPONIBLES/OTHER DIMENSIONS ARE AVAILABLE

NOIR / BARE STEEL : FILETS FINS DISPONIBLES / FINE THREADS AVAILABLE

AUSSI DISPONIBLE / ALSO AVAILABLE :

TIGES FILETÉES CLASS 8,8 / 10,9 (NOIR & ZINC) /
THREADED RODS CLASS 8,8 / 10,9 (BARE & ZINC)

TIGES FILETÉES A2 (18-8) / THREADED RODS A2 (18-8)
TIGES FILETÉES A4 (316) / THREADED RODS A4 (316)



Tel.: (819) 346-2903 / (888) 345-2903 Fax.: (819) 346-3389
Email: distributeur@boulonsestrie.com

ACIER EN RONDIN
ANSI W-1 ACIER À OUTILS
ACIER AU CARBONE NOIR

W-1
WATER HARDENING

DRILL ROD
ANSI W-1 TOOL STEEL
CARBON STEEL
BARE FINISH

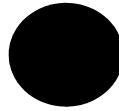

L = 3' (36")

L = 3' (36")

NOTRE CODE	DESCRIPTION	QTÉ/BTE
OUR CODE	DESCRIPTION	QTY/BOX
DR100062	1/16 X 3'	1
DR100078	5/64 X 3'	1
DR100093	3/32 X 3'	1
DR100125	1/8 X 3'	1
DR100156	5/32 X 3'	1
DR100187	3/16 X 3'	1
DR100203	13/64 X 3'	1
DR100250	1/4 X 3'	1
DR100315	5/16 X 3'	1
DR100375	3/8 X 3'	1
DR100437	7/16 X 3'	1
DR100500	1/2 X 3'	1
DR100562	9/16 X 3'	1
DR100625	5/8 X 3'	1
DR100750	3/4 X 3'	1
DR100812	13/16 X 3'	1
DR100875	7/8 X 3'	1
DR100937	15/16 X 3'	1
DR101000	1 X 3'	1
DR101125	1 1/8 X 3'	1
DR101250	1 1/4 X 3'	1
DR101275	1 3/8 X 3'	1

AUSSI DISPONIBLE / ALSO AVAILABLE

ACIER EN RONDIN MÉTRIQUE / METRIC DRILL RODS DIN 175

BARRES RONDES / ROUNDS STEEL

ACIER INOXYDABLE 304 (3' & 12') / STAINLESS STEEL 304 (3' & 12')



Tel.: (819) 346-2903 / (888) 345-2903 Fax.: (819) 346-3389

Email: distributeur@boulonsestrie.com

G-7

GOUPILLES CYLINDRIQUES
ACIER ALLOY NON PLAQUÉ

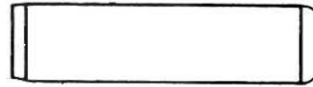

DOWEL PINS
ALLOY STEEL
NOT PLATED
CASE HARDENED

Nom. Dia.	1/16	3/32	1/8	3/16	1/4	5/16	3/8	7/16	1/2
Max Dia.	.0628 "	.0941"	.1253"	.1878"	.2503"	.3128"	.3753"	.4378"	.5003"
Min Dia.	.0626"	.0939"	.1251"	.1876"	.2501"	.3126"	.3751"	.4376"	.5001"
LONGUEUR	AUTRES DIMENSIONS DISPONIBLES/OTHER DIMENSIONS ARE AVAILABLE								
1/4									
3/8	DW006004	DW009004	DW012004		DW025003				
1/2	DW006005	DW009005	DW012005	DW018005	DW025005	DW031005	DW037005		
5/8		DW009006	DW012006	DW018006	DW025006	DW031006	DW037006		
3/4	DW006007	DW009007	DW012007	DW018007	DW025007	DW031007	DW037007		DW050007
7/8		DW009008	DW012008		DW025008	DW031008			
1	DW006010		DW012010	DW018010	DW025010	DW031010	DW037010	DW043010	DW050010
1 1/4			DW012012	DW018012	DW025012	DW031012	DW037012	DW043012	DW050012
1 1/2			DW012015	DW018015	DW025015	DW031015	DW037015	DW043015	DW050015
1 3/4			DW012017	DW018017	DW025017	DW031017	DW037017	DW043017	DW050017
2			DW012020	DW018020	DW025020	DW031020	DW037020	DW043020	DW050020
2 1/4					DW025022	DW031022	DW037022		DW050022
2 1/2					DW025025	DW031025	DW037025	DW043025	DW050025
2 3/4									
3					DW025030	DW031030	DW037030	DW043030	DW050030
3 1/2							DW037035		DW050035
4									DW050040

AUSSI DISPONIBLE / ALSO AVAILABLE

GOUPILLES CYLINDRIQUES ACIER INOXYDABLE 304 & MÉTRIQUE / DOWEL PINS METRIC & STAINLESS STEEL 304

GOUPILLES FENDUES

ZINC / PLATED

COTTER PINS

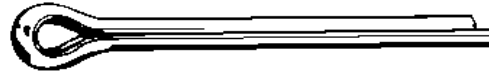

DIA	1/32	3/64	1/16	5/64	3/32	7/64	1/8	5/32	3/16	7/32	1/4	5/16	3/8	1/2
LENGTH	AUTRES DIMENSIONS DISPONIBLES / OTHER DIMENSIONS ARE AVAILABLE													
1/4														
3/8														
1/2			CP106005		CP109005		CP112005							
3/4			CP106007		CP109007		CP112007	CP115007	CP118007					
1			CP106010	CP108010	CP109010	CP111010	CP112010	CP115010	CP118010	CP125010	CP131010			
1 1/4			CP106012		CP109012		CO112012	CP115012	CP118012		CP131012			
1 1/2			CP106015		CP109015		CP112015	CP115015	CP118015	CP125015	CP131015	CP137015		
1 3/4							CP112017	CP115017	CP118017					
2			CP106020		CP109020		CP112020	CP115020	CP118020	CP125020	CP131020	CP137020	CP150020	
2 1/4									CP118022	CP125022	CP131022			
2 1/2					CP109025		CP112025	CP115025	CP118025	CP125025	CP131025	CP137025	CP150025	
2 3/4										CP125027				
3			CP106030				CP112030		CP118030	CP125030	CP131030	CP137030		
3 1/2									CP118035		CP131035		CP150035	
4										CP125040	CP131040		CP150040	
4 1/2									CP118045					
5														
6														
8														

NOIR EST AUSSI DISPONIBLE / BARE FINISH IS AVAILABLE

ACIER INOXYDABLE 304 & 316 AUSSI DISPONIBLE / STAINLESS STEEL 304 & 316 IS AVAILABLE

GOUPILLES FENDUES
À RESSORT

NOIR



SPRING TENSION
PINS

BARE

Nom. Dia.	1/16	5/64	3/32	1/8	5/32	3/16	7/32	1/4	5/16	3/8	7/16	1/2
Out.dia. Before Insertion	0.066 - 0,069	0.083 - 0,086	0.099 - 0,103	0.131 - 0,135	0.162 - 0,167	0.194 - 0,199	0.226 - 0,232	0.258 - 0,264	0.321 - 0,330	0.385 - 0,395	0.448 - 0,459	0.513 - 0,524
Wall Thick.	0,012	0,018	0,022	0,032	0,032	0,040	0,048	0,048	0,062	0,077	0,077	0,094
LONGUEUR	AUTRES DIMENSIONS DISPONIBLES / OTHER DIMENSIONS ARE AVAILABLE											
1/4	PI006025	PI007025	PI009025									
5/16		PI007031	PI009031									
3/8		PI007037	PI009037	PI012037	PI015037	PI018037						
7/16	PI006043	PI007043	PI009043									
1/2	PI006050	PI007050	PI009050	PI012050	PI015050	PI018050		PI025050				
9/16		PI007056		PI012056			PI021056					
5/8	PI006062	PI007062		PI012062		PI018062		PI025062				
11/16		PI007068										
3/4	PI006075	PI007075	PI009075	PI012075	PI015075	PI018075	PI021075	PI025075	PI031075	PI037075		
13/16		PI007081	PI009081						PI031081			
7/8			PI009087	PI012087	PI015087	PI018087						
15/16		PI007093	PI009093	PI012093								
1	PI006100	PI007100	PI009100	PI012100	PI015100	PI018100		PI025100	PI031100	PI037100	PI043100	
1 1/8		PI007112	PI009112	PI012112	PI015112	PI018112	PI021112	PI025112				
1 1/4		PI007125	PI109125	PI012125	PI015125	PI018125		PI025125	PI031125	PI037125	PI043125	
1 3/8												
1 1/2		PI007150	PI109150	PI012150	PI015150	PI018150	PI021150	PI025150	PI031150	PI037150	PI043150	PI050150
1 5/8				PI012162	PI015162							
1 3/4					PI015175	PI018175		PI025175	PI031175			

G-10

ZINC, MÉTRIQUE ET SS-420 DISPONIBLE SUR DEMANDE /
PLATED, METRIC AND SS-420 AVAILABLE ON REQUEST

GOUPILLES FENDUES
À RESSORT

NOIR



SPRING TENSION
PINS

BARE

Nom. Dia.	1/16	5/64	3/32	1/8	5/32	3/16	7/32	1/4	5/16	3/8	7/16	1/2
Out.dia. Before Insertion	0.066 - 0,069	0.083 - 0,086	0.099 - 0,103	0.131 - 0,135	0.162 - 0,167	0.194 - 0,199	0.226 - 0,232	0.258 - 0,264	0.321 - 0,330	0.385 - 0,395	0.448 - 0,459	0.513 - 0,524
Wall Thick.	0,012	0,018	0,022	0,032	0,032	0,040	0,048	0,048	0,062	0,077	0,077	0,094
LONGUEUR	AUTRES DIMENSIONS DISPONIBLES / OTHER DIMENSIONS ARE AVAILABLE											
1 7/8				PI012187	PI015187			PI025187				
2				PI012200		PI018200	PI021200	PI025200	PI031200	PI037200		PI050200
2 1/4						PI018225	PI021225	PI025225		PI037225		PI050225
2 1/2						PI018250		PI025250	PI031250	PI037250		PI050250
2 3/4							PI021275	PI025275		PI037275		
3							PI021300	PI025300	PI031300	PI037300		PI025300
3 1/4								PI025325	PI031325	PI037325		
3 1/2								PI025350	PI031350	PI037350		
3 3/4									PI031375	PI037375		
4										PI037400		PI025400
4 1/2												
5												
5 1/4												
5 1/2												
6												
7												

ZINC, MÉTRIQUE ET SS-420 DISPONIBLE SUR DEMANDE /
PLATED, METRIC AND SS-420 AVAILABLE ON REQUEST

G-11



Tel.: (819) 346-2903 / (888) 345-2903 Fax.: (819) 346-3389

Email: distributeur@boulonsestrie.com

GOUPILLES CONIQUES

TAPER PINS

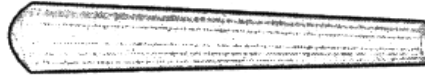

DIMENSION / SIZE	7/0	6/0	4/0	3/0	2/0	1/0	1	2	3	4	5	6
GROS DIAMÈTRE DIAMETER LARGE END	.0625" (1/16)	.0780" (5/64)	.1090" (7/64)	.125" (1/8)	.141" (9/64)	.156" (5/32)	.172" (11/64)	.193" (3/16)	.219" (7/32)	.250" (1/4)	.289" (19/64)	.341" (11/32)
LONGUEUR/LENGTH												
5/8												
3/4				TP703750						TP740750	TP750750	
7/8												
1						TP701000					TP751000	TP761000
1-1/8												
1-1/4										TP741250		
1-1/2					TP720150		TP711500					TP761500
1-3/4												
2						TP702000	TP712000		TP732000	TP741200	TP752000	TP762000
2-1/4												
2-1/2											TP752500	
2-3/4												TP762700
3			TP743000				TP713000		TP733000		TP753000	
3 1/2												
3 3/4												TP763700
4												
4-7/8												
5											TP755000	
6												TP766000

AUTRES LONGUEURS DISPONIBLES/OTHER LENGTHS ARE AVAILABLE



GOUPILLES CONIQUES

TAPER PINS

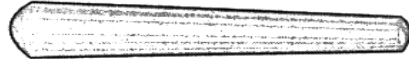

STEEL

DIMENSION/SIZE	7	8	9	10
GROS DIAMETRE	.409"	.492"	.591"	.706"
DIAMETER LARGE END	(13/32)	(1/2)	(19/32)	(23/32)
LONGUEUR/LENGTH				
5/8				
3/4				
7/8				
1				
1-1/8				
1-1/4				
1-1/2	TP772150			
1-3/4				
2	TP772200	TP782000		TP810200
2 -1/4				
2-1/2	TP772500	TP782500	TP792500	TP810250
2-3/4				
3	TP773000			
3 1/2		TP783500		TP810350
3 3/4				
4		TP784000		TP810400
4-1/2				
5		TP785000		TP810500
6	TP776000	TP786000		TP810600

AUSSI DISPONIBLE /ALSO AVAILABLE

**GOUPILLES CONIQUES FILETÉES /
THREADED TAPER PINS**

**MÉTRIQUE/
METRIC**

**ACIER INOXYDABLE 304 & 316 /
STAINLEES STEEL 304 & 316**

AUTRES DIMENSIONS DISPONIBLES / OTHER DIMENSIONS ARE AVAILABLE



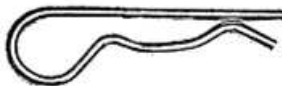

NUMÉRO IND.	NOTRE CODE	CATÉGORIE GRANDEUR	LONGUEUR TOTAL
IND. NUMBER	OUR CODE	SIZE CATEGORY	OVERALL LENGTH
1	HP480001	5/32	3
2	HP480002	1/8	3 1/4
3	HP480003	3/32	1 5/8
4	*****	11/64	3
5	*****	11/64	2 5/8
6	HP480006	3/16	3 1/4
7	HP480007	3/32	2 5/16
8	HP480008	3/16	3 3/4
9	HP480009	5/32	3 5/16
10	HP480010	5/32	2 15/16
11	HP480011	1/8	2 9/16
12	HP480012	11/64	3 7/16
13	HP480013	3/32	1 3/16
14	HP480014	3/32	2 1/2
15	HP480015	1/8	1 9/16
16	HP480016	1/8	1 3/4
17	HP480017	3/32	1 9/16
18	HP480018	1/16	1 9/16
19	HP480019	1/4	4 3/8
20	*****	5/16	3 5/16
21	*****	3/64	9/16
22	*****	1/16	1 5/16
23	*****	3/64	1
24	HP480024	3/64	1 9/16
25	HP480025	5/64	1 3/32
1X	*****	0,032	1 5/32
2X	*****	0,062	1
3X	*****	0,062	11/16
4X	*****	0,047	7/8
5X	*****	0,035	1/2
6X	*****	0,046	1 5/16
7X	*****	0,105	2 1/16
10X	*****	0,177	2 5/8

AUTRES DIMENSIONS DISPONIBLES / OTHER DIMENSIONS ARE AVAILABLE

AUSSI DISPONIBLE SS-302 ALSO AVAILABLE

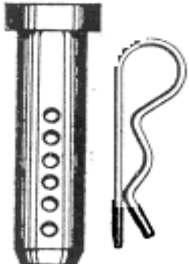

NOTRE CODE	DESCRIPTION	AUSSI DISPONIBLE/ ALSO AVAILABLE
OUR CODE	DESCRIPTION	
*****	1/4 X 2	 GOUPILLES UNIVERSELLES AVEC UNE AGRAFE / UNIVERSAL CLEVIS PIN WITH A HITCH PIN CLIP
CP531020	5/16 X 2	
CP537020	3/8 X 2	
CP543020	7/16 X 2	
CP543030	7/16 X 3	
CP551020	1/2 X 2	
CP551025	1/2 X 2 1/2	
CP562030	5/8 X 3	
*****	3/4 X 3	

GOUPILLES JOUG



CLEVIS PINS

NOTRE CODE	DESCRIPTION
OUR CODE	DESCRIPTION
*****	3/16 X 5/8
*****	1/4 X 51/64
*****	1/4 X 1
CP531007	5/16 X 3/4
CP531009	5/16 X 31/32
CP531011	5/16 X 1 1/8
*****	3/8 X 1 3/32
*****	3/8 X 1 1/4
*****	3/8 X 1 3/8
CP537015	3/8 X 1 1/2
*****	7/16 X 1 15/64
*****	7/16 X 1 1/2
*****	7/16 X 1 3/4
CP550012	1/2 X 1 1/4
CP550016	1/2 X 1 27/64
CP550015	1/2 X 1 1/2
CP550020	1/2 X 2

AUTRES DIMENSIONS
DISPONIBLES

OTHER DIMENSIONS
ARE AVAILABLE



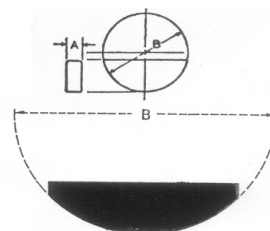
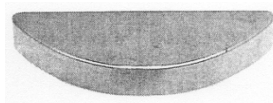

NOTRE CODE	(A) LARGEUR X DIA (B)	QTÉ/BTE
OUR CODE	(A) WIDTH X DIA. (B)	QTY/BOX
WK006005	1/16 X 1/2	25
WK009005	3/32 X 1/2	25
WK009006	3/32 X 5/8	25
WK012005	1/8 X 1/2	25
WK012006	1/8 X 5/8	25
WK012007	1/8 X 3/4	25
WK015006	5/32 X 5/8	25
WK015007	5/32 X 3/4	25
WK015008	5/32 X 7/8	25
WK018006	3/16 X 5/8	25
WK018007	3/16 X 3/4	25
WK018008	3/16 X 7/8	25
WK018010	3/16 X 1	25
WK018011	3/16 X 1 1/8	25
WK018012	3/16 X 1 1/4	25
WK018013	3/16 X 1 3/8	25
WK021011	7/32 X 1 1/8	25
WK021012	7/32 X 1 1/4	25
WK021017	7/32 X 1 3/4	25
WK021022	7/32 X 2 1/4	25
WK025007	1/4 X 3/4	25
WK025008	1/4 X 7/8	25
WK025010	1/4 X 1	25
WK025011	1/4 X 1 1/8	25
WK025012	1/4 X 1 1/4	25
WK025013	1/4 X 1 3/8	25

MÉTRIQUE DISPONIBLE / METRIC AVAILABLE

AUTRES DIMENSIONS DISPONIBLES / OTHER DIMENSIONS ARE AVAILABLE



Tel.: (819) 346-2903 / (888) 345-2903 Fax.: (819) 346-3389

Email: distributeur@boulonsestrie.com

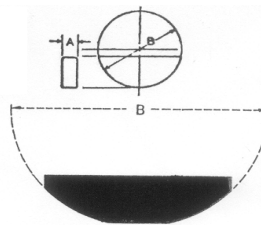
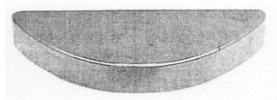

NOTRE CODE	(A) LARGEUR X DIA (B)	QTÉ/BTE
OUR CODE	(A) WIDTH X DIA. (B)	QTY/BOX
WK025015	1/4 X 1 1/2	25
WK025017	1/4 X 1 3/4	25
WK025018	1/4 X 1 7/8	25
WK025020	1/4 X 2	25
WK025022	1/4 X 2 1/4	25
WK025035	1/4 X 3 1/2	25
WK031010	5/16 X 1	25
WK031011	5/16 X 1 1/8	25
WK031012	5/16 X 1 1/4	25
WK031013	5/16 X 1 3/8	25
WK031015	5/16 X 1 1/2	25
WK031017	5/16 X 1 3/4	25
WK031022	5/16 X 2 1/4	25
WK037007	3/8 X 3/4	25
WK037010	3/8 X 1	25
WK037012	3/8 X 1 1/4	25
WK037013	3/8 X 1 3/8	25
WK037015	3/8 X 1 1/2	25
WK037017	3/8 X 1 3/4	25
WK037020	3/8 X 2	25
WK037021	3/8 X 2 1/8	25
WK037022	3/8 X 2 1/4	25
WK037028	3/8 X 2 7/8	25
WK043028	7/16 X 2 7/8	25
WK050022	1/2 X 2 1/4	25

MÉTRIQUE DISPONIBLE / METRIC AVAILABLE

AUTRES DIMENSIONS DISPONIBLES / OTHER DIMENSIONS ARE AVAILABLE



Tel.: (819) 346-2903 / (888) 345-2903 Fax.: (819) 346-3389

Email: distributeur@boulonsestrie.com



NOTRE CODE	DESCRIPTION	QTÉ/BTE
OUR CODE	DESCRIPTION	QTY/BOX
KS000125	1/8 X 1/8 X 12"	1
KS000187	3/16 X 3/16 X 12"	1
KS000250	1/4 X 1/4 X 12"	1
KS000315	5/16 X 5/16 X 12"	1
KS000375	3/8 X 3/8 X 12"	1
KS000437	7/16 X 7/16 X 12"	1
KS000500	1/2 X 1/2 X 12"	1
KS000562	9/16 X 9/16 X 12"	1
KS000625	5/8 X 5/8 X 12"	1
KS000687	11/16 X 11/16 X 12"	1
KS000750	3/4 X 3/4 X 12"	1
KS000875	7/8 X 7/8 X 12"	1
KS001000	1 X 1 X 12"	1
KS001125	1 1/8 X 1 1/8 X 12"	1

AUSSI DISPONIBLE /ALSO AVAILABLE



**EN LONGUEUR DE 144" / LENGTH OF 144"
&**





RECTANGULAIRE / RECTANGULAR



SECTION H

DIVERS / MISCELLANEOUS

INFORMATION TECHNIQUE.....DÉBUT DE LA SECTION
 TECHNICAL INFORMATION.....BEGINNING OF THIS SECTION

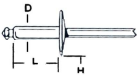
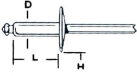
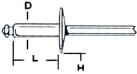
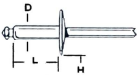
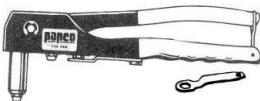
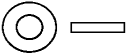
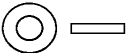
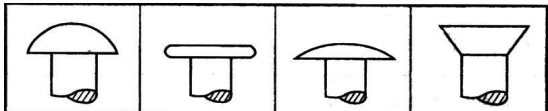
DESCRIPTION	SECTION-PAGE
	<p>BAGUES DE RETENUE, SÉRIE 1000 EXTERNE. RETAINING RINGS, SERIE 1000 EXTERNAL.</p> <p style="text-align: right;">SUR DEMANDE ON REQUEST</p>
	<p>BAGUES DE RETENUE, SÉRIE 3000 INTERNE. RETAINING RINGS, SERIE 3000 INTERNAL.</p> <p style="text-align: right;">H-1</p>
	<p>BAGUES DE RETENUE, SÉRIE 3100 EXTERNE. RETAINING RINGS, SERIE 3100 EXTERNAL.</p> <p style="text-align: right;">H-3</p>
	<p>RIVETS "POP", ALUMINIUM/ALUMINIUM. POP RIVETS, ALUMINUM/ALUMINUM.</p> <p style="text-align: right;">H-5</p>
	<p>RIVETS "POP", ALUMINIUM/ACIER. POP RIVETS, ALUMINUM/STEEL.</p> <p style="text-align: right;">H-6</p>
	<p>RIVETS "POP", ACIER/ACIER. POP RIVETS, STEEL/STEEL.</p> <p style="text-align: right;">H-7</p>
	<p>RIVETS "POP", ACIER INOX./ACIER INOX. POP RIVETS, STAINLESS STEEL /STAINLESS STEEL.</p> <p style="text-align: right;">H-8</p>
	<p>OUTILS DE RIVETAGE. RIVETING TOOLS.</p> <p style="text-align: right;">H-8</p>
	<p>RONDELLES PLATES POUR RIVETS "POP", ACIER. FLAT WASHERS FOR POP RIVETS, STEEL.</p> <p style="text-align: right;">H-9</p>
	<p>RONDELLES PLATES POUR RIVETS "POP", ALUMINIUM. FLAT WASHERS FOR POP RIVETS, ALUMINUM.</p> <p style="text-align: right;">H-9</p>
	<p>RIVETS SOLIDES . SOLID RIVETS.</p> <p style="text-align: right;">SUR DEMANDE ON REQUEST</p>

SECTION H

DIVERS / MISCELLANEOUS

	DESCRIPTION	SECTION-PAGE
	PIÈCES FILETÉES DE RECHANGE, <i>GROS FILETS</i> . THREAD REPAIR INSERTS, <i>NATIONAL COARSE</i> .	H-10
	PIÈCES FILETÉES DE RECHANGE, <i>FILETS FINS</i> . THREAD REPAIR INSERTS, <i>NATIONAL FINE</i> .	H-12
	ENS. PIÈCES FILETÉES DE RECHANGE, <i>GROS FILETS</i> . THREAD REPAIR INSERTS KITS, <i>NATIONAL COARSE</i> .	H-13
	ENS. PIÈCES FILETÉES DE RECHANGE, <i>FILETS FINS</i> . THREAD REPAIR INSERTS KITS, <i>NATIONAL FINE</i> .	H-13
	PIÈCES FILETÉES DE RECHANGE, MÉTRIQUE. THREAD REPAIR INSERTS, METRIC.	H-14
	ENS. PIÈCES FILETÉES DE RECHANGE, MÉTRIQUE. THREAD REPAIR INSERTS KITS, METRIC.	H-14
	TARAUDS À PIÈCES FILETÉES DE RECHANGE, INTERMÉDIAI	H-16



NOTRE CODE	D	A	T	G=DIA	W=WIDTH
OUR CODE	HOUSING DIA.	FREE DIA.	RING THICK	GROOVE	
SR300025	1/4 (.250)	.280	.015	.268	.018
SR300031	5/16 (.315)	.346	.015	.330	.018
SR300037	3/8 (.375)	.415	.025	.397	.029
SR300043	7/16 (.438)	.482	.025	.461	.029
SR300045	29/64 (.453)	.498	.025	.477	.029
SR300050	1/2 (.500)	.548	.035	.530	.039
SR300056	9/16 (.562)	.620	.035	.596	.039
SR300062	5/8 (.625)	.694	.035	.665	.039
SR300068	11/16 (.688)	.763	.035	.732	.039
SR300075	3/4 (.750)	.831	.035	.796	.039
SR300081	13/16 (.812)	.901	.042	.862	.046
SR300087	7/8 (.875)	.971	.042	.931	.046
SR300093	15/16 (.938)	1.041	.042	1.000	.046
SR300100	1 (1.00)	1.111	.042	1.066	.046
SR300102	* (1.023)	1.136	.042	1.091	.046
SR300106	1-1/16 (1.062)	1.180	.050	1.130	.056
SR300112	1-1/8 (1.125)	1.249	.050	1.197	.056
SR300118	1-3/16 (1.188)	1.319	.050	1.262	.056
SR300125	1-1/4 (1.250)	1.388	.050	1.330	.056
SR300131	1-5/16 (1.312)	1.456	.050	1.396	.056
SR300137	1-3/8 (1.375)	1.526	.050	1.461	.056
SR300143	1-7/16 (1.438)	1.596	.050	1.528	.056
SR300150	1-1/2 (1.500)	1.660	.050	1.594	.056
SR300156	1-9/16 (1.562)	1.734	.062	1.658	.068
SR300162	1-5/8 (1.625)	1.804	.062	1.725	.068
SR300165	* (1.653)	1.835	.062	1.755	.068
SR300168	1-11/16 (1,688)	1.874	.062	1.792	.068
SR300175	1-3/4 (1.750)	1.942	.062	1.858	.068
SR300181	1-13/16 (1.812)	2.012	.062	1.922	.068
SR300187	1-7/8 (1.875)	2.072	.062	1.989	.068
SR300193	1-15/16 (1.938)	2.141	.062	2.056	.068
SR300200	2 (2.000)	2.210	.062	2.122	.068
SR300206	2-1/16 (2.062)	2.280	.078	2.186	.086
SR300212	2-1/8 (2.125)	2.350	.078	2.251	.086
*****	2-3/16 (2.188)	2.415	.078	2.318	.086
SR300225	2-1/4 (2.250)	2.490	.078	2.232	.086

AUTRES DIMENSIONS DISPONIBLES / OTHER DIMENSIONS ARE AVAILABLE



Tel.: (819) 346-2903 / (888) 345-2903 Fax.: (819) 346-3389

Email: distributeur@boulonstrie.com



NOTRE CODE	D	A	T	G=DIA	W=WIDTH
OUR CODE	HOUSING DIA.	FREE DIA.	RING THICK	GROOVE	
*****	2-5/16 (2.312)	2.560	.078	2.450	.086
SR300237	2-3/8 (2.375)	2.630	.078	2.517	.086
SR300244	2-7/16 (2.440)	2.702	.078	2.584	.086
SR300250	2-1/2 (2.500)	2.775	.078	2.648	.086
SR300262	2-5/8 (2.625)	2.910	.093	2.781	.103
SR300268	2-11/16 (2.688)	2.980	.093	2.848	.103
SR300275	2-3/4 (2.750)	3.050	.093	2.914	.103
SR300281	2-13/16 (2.812)	3.121	.093	2.980	.103
SR300287	2-7/8 (2.875)	3.191	.093	3.051	.103
SR300300	3 (3.000)	3.325	.093	3.182	.103
SR300306	3-1/16 (3.062)	3.418	.109	3.248	.120
*****	3-1/8 (3.125)	3.488	.109	3.315	.120
SR300315	3-5/32 (3.156)	3.523	.109	3.348	.120
*****	3-1/4 (3.250)	3.623	.109	3.446	.120
SR300350	3-1/2 (3.500)	3.890	.109	3.710	.120

AUTRES DIMENSIONS DISPONIBLES / OTHER DIMENSIONS ARE AVAILABLE

AUSSI DISPONIBLE / ALSO AVAILABLE

PLAQUÉ ZINC / ZINC PLATED

STAINLESS STEEL PH 15-7 Mo



Tel.: (819) 346-2903 / (888) 345-2903 Fax.: (819) 346-3389

Email: distributeur@boulonsestrie.com



NOTRE CODE	D	A	T	G=DIA	W=WIDTH
OUR CODE	HOUSING DIA.	FREE DIA.	RING THICK	GROOVE	
SR310018	3/16 (.188)	.168	.015	.175	.018
SR310025	1/4 (.250)	.225	.025	.230	.029
SR310031	5/16 (.315)	.281	.025	.290	.029
SR310035	* (.354)	.320	.025	.330	.029
SR310037	3/8 (.375)	.338	.025	.352	.029
*****	* (.394)	.354	.025	.369	.029
SR310040	13/32 (.406)	.366	.025	.382	.029
SR310043	7/16 (.438)	.395	.025	.412	.029
SR310046	15/32 (.469)	.468	.025	.443	.029
SR310050	1/2 (.500)	.461	.035	.468	.039
SR310056	9/16 (.562)	.521	.035	.530	.039
SR310059	19/32 (.594)	.550	.035	.559	.039
SR300062	5/8 (.625)	.579	.035	.558	.039
SR310066	* (.669)	.621	.035	.629	.039
SR310067	43/64 (.672)	.621	.035	.631	.039
SR310068	11/16 (.688)	.635	.042	.646	.046
SR310075	3/4 (.750)	.693	.042	.704	.046
SR310078	25/32 (.781)	.722	.042	.733	.046
SR310081	13/16 (.812)	.751	.042	.762	.046
SR310084	27/32 (.844)	.780	.042	.791	.046
SR310087	7/8 (.875)	.810	.042	.821	.046
SR310093	15/16 (.938)	.867	.042	.882	.046
SR310098	63/64 (.984)	.910	.042	.926	.046
SR310100	1 (1.00)	.925	.042	.940	.046
SR310102	* (1.023)	.946	.042	.961	.046
SR310106	1-1/16 (1.062)	.982	.050	.998	.056
SR310112	1-1/8 (1.125)	1.041	.050	1.059	.056
SR310118	1-3/16 (1.188)	1.098	.050	1.118	.056
SR310125	1-1/4 (1.250)	1.156	.050	1.176	.056
SR310131	1-5/16 (1.312)	1.214	.050	1.232	.056
SR310137	1-3/8 (1.375)	1.272	.050	1.291	.056
SR310143	1-7/16 (1.438)	1.333	.050	1.350	.056
SR310150	1-1/2 (1.500)	1.387	.050	1.406	.056
SR310156	1-9/16 (1.562)	1.446	.062	1.468	.068
SR310162	1-5/8 (1.625)	1.446	.062	1.529	.068
SR310168	1-11/16(1.688)	1.560	.062	1.589	.068
SR310175	1-3/4 (1.750)	1.618	.062	1.650	.068

AUTRES DIMENSIONS DISPONIBLES / OTHER DIMENSION ARE AVAILABLE



Tel.: (819) 346-2903 / (888) 345-2903 Fax.: (819) 346-3389

Email: distributeur@boulonstrie.com



NOTRE CODE	D	A	T	G=DIA	W=WIDTH
OUR CODE	HOUSING DIA.	FREE DIA.	RING THICK	GROOVE	
*****	* (1.772)	1.637	.062	1.669	.068
*****	1-13/16 (1.812)	1.675	.062	1.708	.068
SR310187	1-7/8 (1.875)	1.735	.062	1.769	.068
SR310196	1-31/32 (1.969)	1.819	.062	1.857	.068
SR310200	2 (2.000)	1.850	.062	1.886	.068
SR310206	2-1/16 (2.062)	1.906	.078	1.946	.086
SR310212	2-1/8 (2.125)	1.964	.078	2.003	.086
SR310215	2-5/32 (2.156)	1.993	.078	2.032	.086
SR310225	2-1/4 (2.250)	2.081	.078	2.120	.086
SR310231	2-5/16 (2.375)	2.139	.078	2.178	.086
SR310237	2-3/8 (2.375)	2.197	.078	2.239	.086
SR310243	2-7/16 (2.440)	2.255	.078	2.299	.086
SR310250	2-1/2 (2.500)	2.313	.078	2.360	.086
SR310262	2-5/8 (2.625)	2.428	.078	2.481	.086
*****	2-11/16 (2.688)	2.485	.078	2.541	.086
SR310275	2-3/4 (2.750)	2.543	.093	2.602	.103
SR310287	2-7/8 (2.875)	2.659	.093	2.721	.103
SR310293	2-15/16 (2.938)	2.717	.093	2.779	.103
SR310300	3 (3.000)	2.775	.093	2.828	.103
SR310306	3-1/16 (3.062)	2.832	.093	2.898	.103
*****	3-1/8 (3.125)	2.892	.093	2.957	.103
SR310315	3-5/32 (3.156)	2.920	.093	2.986	.103
*****	3-1/4 (3.250)	3.006	.093	3.076	.103
SR310343	3-7/16 (3.438)	3.179	.093	3.257	.103
SR310350	3-1/2 (3.500)	3.237	.109	3.316	.120

AUTRES DIMENSIONS DISPONIBLES / OTHER DIMENSIONS ARE AVAILABLE

AUSSI DISPONIBLE / ALSO AVAILABLE

PLAQUÉ ZINC / ZINC PLATED

STAINLESS STEEL PH 15-7 Mo



Tel.: (819) 346-2903 / (888) 345-2903 Fax.: (819) 346-3389

Email: distributeur@boulonstrie.com

**CORPS D'ALUMINIUM / CLOU D'ALUMINIUM
ALUMINUM BODY / ALUMINUM MANDREL**

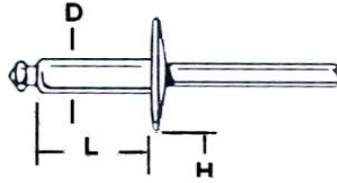

NOTRE CODE	RIVET BODY DIA.	GRIP RANGE	BODY LENGHT
OUR CODE	D	H	L
*****	3/32	.031 À .125	.240
*****	3/32	.126 À .250	.365
*****	3/32	.251 À .375	.490
PR10041	1/8	.031 À .062	.203
PR10042	1/8	.063 À .125	.265
PR10043	1/8	.126 À .187	.328
PR10044	1/8	.188 À .250	.390
PR10045	1/8	.251 À .312	.453
PR10046	1/8	.313 À .375	.515
PR10048	1/8	.376 À .500	.640
PR100410	1/8	.501 À .625	.765
*****	5/32	.063 À .125	.290
*****	5/32	.126 À .187	.365
PR10054	5/32	.188 À .250	.415
PR10056	5/32	.251 À .375	.540
PR10058	5/32	.376 À .500	.665
PR10062	3/16	.063 À .125	.315
PR10064	3/16	.126 À .250	.440
PR10066	3/16	.251 À .375	.565
PR10068	3/16	.376 À .500	.690
PR100610	3/16	.501 À .625	.815
PR100612	3/16	.626 À .750	.940
*****	3/16	.751 À 1.00	1.190
*****	1/4	.063 À .250	.490
PR10086	1/4	.251 À .375	.615
PR10088	1/4	.376 À .500	.740
PR100812	1/4	.625 À .750	.990

**AUSSI DISPONIBLE / ALSO AVAILABLE:
COLLERETTE LARGE / LARGE FLANGE**

**CORPS D'ALUMINIUM / CLOU D'ACIER
ALUMINUM BODY / STEEL MANDREL**

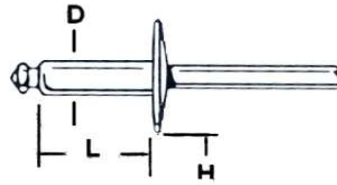

NOTRE CODE	RIVET BODY DIA.	GRIP RANGE	BODY LENGHT
OUR CODE	D	H	L
PR110041	1/8	.031 À .062	.203
PR110042	1/8	.063 À .125	.265
PR110043	1/8	.126 À .187	.328
PR110044	1/8	.188 À .250	.390
PR110045	1/8	.251 À .312	.453
PR110046	1/8	.313 À .375	.515
PR110048	1/8	.376 À .500	.640
PR110049	1/8	.501 À .625	.765
PR110052	5/32	.063 À .125	.290
PR110053	5/32	.126 À .187	.353
PR110054	5/32	.188 A .250	.415
PR110058	5/32	.376 À .500	.665
PR110062	3/16	.063 À .125	.345
PR110064	3/16	.126 À .250	.440
PR110066	3/16	.251 À .375	.565
PR110068	3/16	.376 À .500	.690
PR110610	3/16	.501 À .625	.815
PR110612	3/16	.626 À .750	.940
PR110084	1/4	.063 À .250	.490
PR110086	1/4	.251 À .375	.615
PR110088	1/4	.376 À .500	.740
PR110810	1/4	.501 À .625	.865
PR110812	1/4	.626 À .750	.990

**AUSSI DISPONIBLE / ALSO AVAILABLE:
COLLERETTE LARGE / LARGE FLANGE**

**CORPS D'ACIER / CLOU D'ACIER
STEEL BODY / STEEL MANDREL**

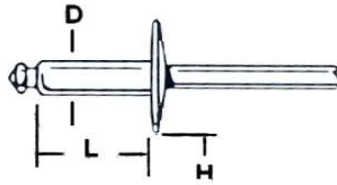

NOTRE CODE	RIVET BODY DIA.	GRIP RANGE	BODY LENGHT
OUR CODE	D	H	L
*****	3/32	.031 À .125	.240
*****	3/32	.126 À .250	.365
PR120041	1/8	.031 À .062	.203
PR120042	1/8	.063 À .125	.265
PR120043	1/8	.126 À .187	.328
PR120044	1/8	.188 À .250	.390
PR120045	1/8	.251 À .312	.453
PR120046	1/8	.313 À .375	.515
PR120048	1/8	.376 À .500	.640
*****	5/32	.063 À .125	.290
PR120053	5/32	.126 À .187	.353
PR120054	5/32	.188 À .250	.415
PR120056	5/32	.251 À .375	.540
PR120062	3/16	.063 À .125	.315
PR120064	3/16	.126 À .250	.440
PR120066	3/16	.251 À .375	.565
PR120068	3/16	.376 À .500	.690
PR120069	3/16	.501 À .625	.815
*****	3/16	.626 À .750	.940
*****	3/16	.751 À .875	1.065
*****	3/16	.751 À 1.000	1.190
*****	1/4	.063 À .250	.490
PR120086	1/4	.251 À .375	.615
PR120088	1/4	.376 À .500	.740
*****	1/4	.501 À .625	.865
*****	1/4	.626 À .750	.990
*****	1/4	.751 À 1.000	1.240

**AUSSI DISPONIBLE / ALSO AVAILABLE:
COLLERETTE LARGE / LARGE FLANGE**

CORPS EN ACIER INOXYDABLE / CLOU EN ACIER INOXYDABLE
BODY IN STAINLESS STEEL / MANDREL IN STAINLESS STEEL

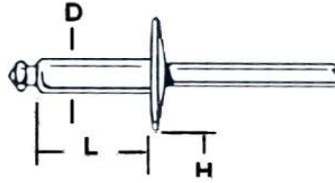

NOTRE CODE	RIVET BODY DIA.	GRIP RANGE	BODY LENGHT
OUR CODE	D	H	L
PR120142	1/8	.031 À .125	.265
PR120143	1/8	.126 À .187	.328
PR120144	1/8	.188 À .250	.390
PR120146	1/8	.313 À .375	.515
PR120148	1/8	.376 À .500	.640
*****	5/32	.063 À .125	.290
PR120154	5/32	.126 À .250	.415
*****	5/32	.251 À .375	.540
PR120162	3/16	.063 À .125	.315
PR120164	3/16	.126 À .250	.440
PR120166	3/16	.251 À .375	.565
PR120168	3/16	.376 À .500	.690
PR120610	3/16	.501 À .625	.815
PR120612	3/16	.626 À .750	.940
PR120810	1/4	.501 À .625	.865

AUSSI DISPONIBLE / ALSO AVAILABLE:
COLLERETTE LARGE / LARGE FLANGE

OUTILS DE RIVETAGE

RIVETING TOOLS

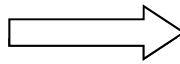
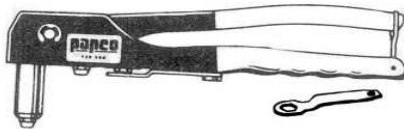

SUR DEMANDE / ON REQUEST
OUTIL ÉCONOMIQUE /
MEDIUM DUTY BLIND RIVETER

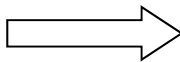
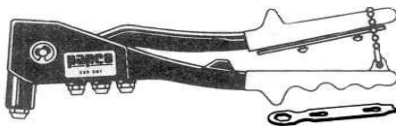

NO: OU901000
RIVETEUSE GROS TRAVAUX /
HEAVY DUTY BLIND RIVETER

*100, 500, 1000 / BOÎTE
 *100, 500, 1000 / BOX

RONDELLES DE RENFORT/ BACK UP PLATE

RONDELLES PLATES
POUR RIVET "POP"

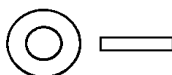

FLAT WASHERS
FOR POP RIVETS

ALUMINIUM / ALUMINUM

NOTRE CODE	DESCRIPTION	QTÉ/BTE
OUR CODE	DESCRIPTION	QTY/BOX
PR000125	1/8	100
PR000156	5/32	100
PR000187	3/16	100

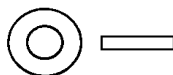

ACIER/STEEL

NOTRE CODE	DESCRIPTION	QTÉ/BTE
OUR CODE	DESCRIPTION	QTY/BOX
PR002125	1/8	100
PR002187	3/16	100



Tel.: (819) 346-2903 / (888) 345-2903 Fax.: (819) 346-3389

Email: distributeur@boulonsestrie.com



NOTRE CODE	DESCRIPTION	DIA. MÈCHE POUR... / DRILL SIZES FOR...	
OUR CODE	DESCRIPTION	ALUMINIUM	STEEL-MAGNESIUM-PLASTIC
HC300112	4-40 X .112	# 31	# 31
HC300113	4-40 X .168	# 31	# 31
HC300114	4-40 X .224	# 31	# 31
HC300119	5-40 X .188	3.4 mm	3.4 mm
HC300137	6-32 X .138	# 26	# 27
HC300138	6-32 X .207	# 26	# 27
HC300140	6-32 X .276	# 26	# 27
HC300164	8-32 X .246	# 17	# 16
HC300165	8-32 X .328	# 17	# 16
HC300186	10-24 X .285	13/64	# 5
HC300187	10-24 X .380	13/64	# 5
HC300252	1/4-20 X .250	# H	# H
HC300253	1/4-20 X .375	# H	# H
HC300255	1/4-20 X .500	# H	# H
HC300312	5/16-18 X .312	# Q	# Q
HC300314	5/16-18 X .469	# Q	# Q
HC300316	5/16-18 X .625	# Q	# Q
HC300377	3/8-16 X .375	# X	# X
HC300378	3/8-16 X .562	# X	# X
HC300379	3/8-16 X .750	# X	# X
HC300437	7/16-14 X .438	29/64	29/64
HC300438	7/16-14 X .656	29/64	29/64
HC300440	7/16 X-14 X .875	29/64	29/64
HC300500	1/2-13 X .500	33/64	17/32
HC300503	1/2-13 X .750	33/64	17/32

AUTRES DIMENSIONS DISPONIBLES/OTHER DIMENSIONS ARE AVAILABLE



Tel.: (819) 346-2903 / (888) 345-2903 Fax.: (819) 346-3389

Email: distributeur@boulonstrie.com



NOTRE CODE	DESCRIPTION	DIA. MÈCHE POUR... / DRILL SIZES FOR...	
OUR CODE	DESCRIPTION	ALUMINIUM	STEEL-MAGNESIUM-PLASTIC
HC300505	1/2-13 X 1.00	33/64	17/32
HC300562	9/16 -12 X .562	37/64	19/32
HC300564	9/16-12 X .844	37/64	19/32
HC300568	9/16-12 X 1.125	37/64	19/32
HC300625	5/8 -11 X .625	21/32	21/32
HC300627	5/8-11 X .938	21/32	21/32
HC300630	5/8-11 X 1.250	21/32	21/32
HC300750	3/4-10 X .750	25/32	25/32
HC300752	3/4-10 X 1.875	25/32	25/32
HC300753	3/4-10 X 1.500	25/32	25/32
HC300875	7/8-9 X .875	29/32	29/32
HC300879	7/8-9 X 1.312	29/32	29/32
HC300882	7/8-9 X 1.750	29/32	29/32
HC301000	1-8 X 1.00	1 1/32	1 1/32
HC301005	1-8 X 1.500	1 1/32	1 1/32

AUTRES DIMENSIONS DISPONIBLES/OTHER DIMENSIONS ARE AVAILABLE



Tel.: (819) 346-2903 / (888) 345-2903 Fax.: (819) 346-3389

Email: distributeur@boulonsestrie.com

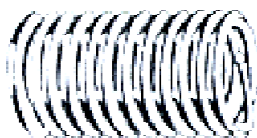

NOTRE CODE	DESCRIPTION	DIA.MÈCHE POUR... / DRILL SIZES FOR...	
OUR CODE	DESCRIPTION	ALUMINIUM	STEEL-MAGNESIUM-PLASTIC
HC000190	10-32 X .190	# 7	13/64
HC000191	10-32 X .285	# 7	13/64
HC000250	1/4-28 X .250	G	6.7 mm
HC000251	1/4-28 X .375	G	6.7 mm
HC000252	1/4-28 X .500	G	6.7 mm
HC000315	5/16-24 X .312	21/64	21/64
HC000316	5/16-24 X .469	21/64	21/64
HC000318	5/16-24 X .625	21/64	21/64
HC000375	3/8-24 X .375	25/64	25/64
HC000377	3/8-24 X .562	25/64	25/64
HC000379	3/8-24 X .750	25/64	25/64
HC000437	7/16-20 X .438	29/64	29/64
HC000439	7/16-20 X .656	29/64	29/64
HC000441	7/16-20 X .875	29/64	29/64
HC000500	1/2-20 X .500	33/64	33/64
HC000562	9/16-18 X .562	37/64	37/64
HC000565	9/16-18 X .844	37/64	37/64
HC000568	9/16-18 X 1.125	37/64	37/64
HC000625	5/8-18 X .625	41/64	41/64
HC000750	3/4-16 X .750	49/64	49/64
HC000753	3/4-16 X 1.125	49/64	49/64
HC000755	3/4-16 X 1.500	49/64	49/64
HC000875	7/8-14 X .875	57/64	57/64
HC000878	7/8-14 X 1.312	57/64	57/64
HC000880	7/8-14 X 1.75	57/64	57/64
HC001000	1-14 X 1.500	1 1/64	1 1/32
HC001005	1-14 X 2.00	1 1/64	1 1/32

AUTRES DIMENSIONS DISPONIBLES / OTHER DIMENSIONS ARE AVAILABLE



Tel.: (819) 346-2903 / (888) 345-2903 Fax.: (819) 346-3389

Email: distributeur@boulonstrie.com

CHAQUE ENSEMBLE CONTIENT/ EACH KIT CONTAIN:

1 TARAUD À MAIN PLUG (#2) / 1 PLUG (#2) TAP
 1 OUTIL D'INSTALLATION / 1 HAND TOOL
 PIÈCES FILETÉES DE RECHANGE (6) /
 THREAD REPAIR INSERTS (6)

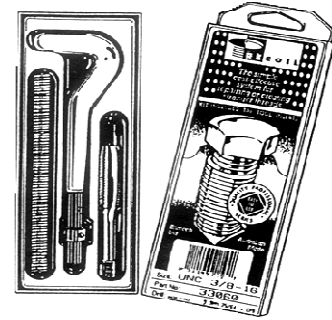
***GROS FILETS / NATIONAL COARSE***

NOTRE CODE	DESCRIPTION
OUR CODE	DESCRIPTION
*****	6-32
HK500008	8-32
HK500010	10-24
HK500012	12-24
HK500250	1/4-20
HK500312	5/16-18
HK500375	3/8-16
HK500437	7/16-14
HK500500	1/2-13
HK500562	9/16-12
HK500625	5/8-11
HK500750	3/4-10

PIÈCES FILETÉES DE RECHANGE EN ACIER INOXYDABLE /
 THREAD REPAIR INSERTS IN STAINLESS STEEL

FILETS FINS / NATIONAL FINE

NOTRE CODE	DESCRIPTION
OUR CODE	DESCRIPTION
HK500006	6-40
*****	8-36
HK500011	10-32
*****	12-28
HK500251	1/4-28
HK500313	5/16-24
HK500376	3/8-24
HK500438	7/16-20
*****	1/2-20
HK500563	9/16-18
HK500626	5/8-18
HK500751	3/4-16

PIÈCES FILETÉES DE RECHANGE EN ACIER INOXYDABLE /
 THREAD REPAIR INSERTS IN STAINLESS STEEL



Tel.: (819) 346-2903 / (888) 345-2903 Fax.: (819) 346-3389
 Email: distributeur@boulonstrie.com

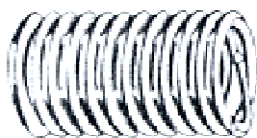

NOTRE CODE	DESCRIPTION	QTÉ/BTE
OUR CODE	DESCRIPTION	QTY/BOX
HC406010	M6 X 1.00 X 9 mm	100
HC408124	M8 X 1.25 X 12 mm	100
HC408125	M8 X 1.25 X 16 mm	100
HC410015	M10 X 1.50 X 15 mm	100
HC412017	M12 X 1.75 X 18 mm	100
HC414012	M14 X 1.25 X .375"	50
HC414013	M14 X 1.25 X .750"	50
HC414014	M14 X 1.50 X 21 mm	50
HC414020	M14 X 2.00 X 21 mm	50
HC416015	M16 X 1.50 X 16 mm	50
HC416016	M16 X 1.50 X 24 mm	50
HC416024	M16 X 2.00 X 24 mm	50
HC418015	M18 X 1.50 X .500"	25
HC418020	M18 X 1.50 X 25 mm	25
HC418025	M18 X 2.50 X 27 mm	25
HC420025	M20 X 2.50 X 30 mm	10

ENSEMBLE DE PIÈCES
FILETÉES DE RECHANGE

MÉTRIQUE / METRIC

NOTRE CODE	DESCRIPTION
OUR CODE	DESCRIPTION
HK600004	M4 X 0.70
HK600005	M5 X 0.80
HK600006	M6 X 1.00
HK600007	M7 X 1.00
HK600008	M8 X 1.25
HK600010	M10 X 1.50
HK600012	M12 X 1.50
HK600013	M12 X 1.75
HK600014	M14 X 2.00
HK600016	M16 X 2.00

THREAD REPAIR INSERTS KITS

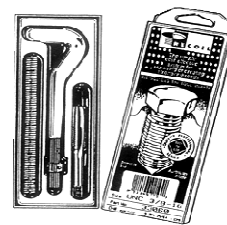

CHAQUE ENSEMBLE CONTIENT:

- 1 TARAUD À MAIN PLUG (#2)
- 1 OUTIL D'INSTALLATION
- PIÈCES FILETÉES DE RECHANGE (6)

EACH KIT CONTAIN:

- 1 PLUG (#2) TAP
- 1 HAND TOOL
- THRED REPAIR INSERTS (6)



MATÉRIEL: OXYDE DE CARBONE	FILET / THREAD			GRANDEUR / SIZE		FILET / THREAD	
	INTÉRIEUR INTERNAL	EXTÉRIEUR EXTERNAL	LONGUEUR LENGTH	MÈCHE TAP DRILL	TARAUD TAP	MIN. PROFOND MIN. DEPTH	
MADE OF CARBON STEEL	4-40	10-32	0,250	5/32	10/32	9/32	
	6-32	1/4-20	0,280	7	1/4-20	11/32	
	8-32	5/16-18	0,290	F	5/16-18	7/16	
	GROS FILETS COARSE THREAD	10-24	3/8-16	0,406	5/16	3/8-16	15/32
		1/4-20	7/16-14	0,437	23/64	7/16-14	1/2
		5/16-18	1/2-13	0,484	27/64	1/2-13	9/16
		3/8-16	9/16-12	0,515	31/64	9/16-12	19/32
		7/16-14	5/8-11	0,656	17/32	5/8-11	23/32
		1/2-13	3/4-10	0,656	21/32	3/4-10	3/4
		5/8-11	7/8-9	0,687	49/64	7/8-9	13/16
		5/8-11	7/8-9	1,125	49/64	7/8-9	1 1/4
		3/4-10	1-8	0,781	7/8	1-8	7/8
		7/8-9	1 1/4-7	1,125	1 7/64	1 1/4-7	1 1/8
	1-8	1 3/8-12	1,250	1 9/32	1 3/8-12	1 3/8	
	FILETS FINS FINE THREAD	10-32	3/8-16	0,406	5/16	3/8-16	15/32
		1/4-28	7/16-14	0,437	23/64	7/16-14	1/2
5/16-24		1/2-13	0,484	27/64	1/2-13	9/16	
3/8-24		9/16-12	0,515	31/64	9/16-12	19/32	
7/16-20		5/8-11	0,656	17/32	5/8-11	23/32	
1/2-20		3/4-10	0,656	21/32	3/4-10	3/4	
5/8-18		7/8-9	0,687	49/64	7/8-9	13/16	
3/4-16		1-8	0,781	7/8	1-8	7/8	
FILETS MÉTRIQUES METRIC THREAD	M4-0,7	M8-1,25	7,5 mm	6,9 mm	M8-1,25	9,00 mm	
	M6-1,0	3/8-16	0,406	5/16	3/8-16	15/32	
	M8-1,25	1/2-13	0,484	27/64	1/2-13	9/16	
	M10-1,50	9/16-12	0,515	31/64	9/16-12	19/32	
	M12-1,75	3/4-10	0,656	31/32	3/4-10	3/4	
	M14-2,0	7/8-9	0,687	49/64	7/8-9	13/16	
	M16-2,0	1-8	0,781	7/8	1-8	7/8	



MÉTRIQUE DISPONIBLE
SUR DEMANDE

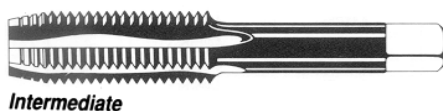

METRIC AVAILABLE
ON REQUEST

NOTRE CODE	DESCRIPTION
OUR CODE	DESCRIPTION
HC700112	4-48 NF
HC700164	8-32 NC
HC700190	10-24 NC
HC700216	12-24 NC
HC700250	1/4-20 NC
HC700316	5/16-24 NF
HC700437	7/16-14 NC
HC700500	1/2-13 NC
HC700501	1/2-20 NF
HC700562	9/16-12 NC
HC700563	9/16-18 NF
HC700625	5/8-11 NC
HC700626	5/8-18 NF
HC700751	3/4-16 NF
HC700876	7/8-14 NF

AUTRES DIMENSIONS DISPONIBLE / OTHER DIMENSIONS ARE AVAILABLE

OUTILS D'INSTALLATION



INSTALLATION TOOLS

MÉTRIQUE DISPONIBLE
SUR DEMANDE

METRIC AVAILABLE
ON REQUEST

NOTRE CODE	DESCRIPTION
OUR CODE	DESCRIPTION
HC800190	10-24 NC
HC800216	12-24 NC
HC800315	5/16-18 NC
HC800437	7/16-14 NC
HC800500	1/2-13 NC
HC800625	5/8-11 NC
HC800751	3/4-16 NF

AUTRES DIMENSIONS DISPONIBLE / OTHER DIMENSIONS ARE AVAILABLE



DROIT / 30 DEG(2) 45 DEG(3) 67 1/2 DEG(4) 90 DEG(5) THREAD FORMING(6)

STRAIGHT (1)

NOTRE CODE	TYPE	DESCRIPTION	QTÉ/BTE
OUR CODE	TYPE	DESCRIPTION	QTY/BOX
GF904610	1	1/8 NPT DROIT / STRAIGHT	25
GF904611	2	1/8 NPT 30 DEGRÉS / DEGRES	25
GF904688	3	1/8 NPT 45 DEGRÉS / DEGRES	25
GF904612	4	1/8 NPT 67 1/2 DEGRÉS / DEGRES	25
GF904613	5	1/8 NPT 90 DEGRÉS / DEGRES	25
GF904627	1	1/4 NPT DROIT / STRAIGHT	25
GF904629	4	1/4 NPT 67 1/2 DEGRÉS / DEGRES	25
GF904641	1	1/4-28 DROIT / STRAIGHT	25
GF904636	3	1/4-28 45 DEGRÉS COURT / DEGRES SHORT	25
GF904637	3	1/4-28 45 DEGRÉS LONG / DEGRES LONG	25
GF904652	1	1/4-28 DROIT LONG / STRAIGHT LONG	25
GF904690	6	1/4-28 THREAD FORMING	25
GF904691	5	1/4-28 90 DEGRÉS / DEGRES	25
GF904992	1	5/16-24 DROIT / STRAIGHT	25
GF904693	1	3/8-24 DROIT / STRAIGHT	25

OUR CODE	TYPE	DESCRIPTION	QTÉ/BTE
NOTRE CODE	TYPE	DESCRIPTION	QTY/BOX
GF904701	1	6 mm X 1.0 DROIT / STRAIGHT	25
GF904745	3	6mm X 1.0 45 DEGRÉS / DEGRES	25
GF904790	5	6mm X 1.0 90 DEGRÉS / DEGRES	25
GF904702	1	8mm X 1.0 DROIT / STRAIGHT	25
GF904746	1	8mm X 1.0 45 DEGRÉS / DEGRES	25
GF904791	3	8 mm X 1.0 90 DEGRÉS / DEGRES	25
GF904703	5	10 mm X 1.0 DROIT / STRAIGHT	25
GF904792	3	10mm X 1.0 45 DEGRÉS / DEGRES	25
GF904793	5	10mm X 1.0 90 DEGRÉS / DEGRES	25

AUSSI DISPONIBLE / ALSO AVAILABLE: GREASE FITTING " PRESS FIT"

**CONTENANTS & SYSTEMES DE RANGEMENT
SYSTEMS OF SHELVING & CONTAINERS**

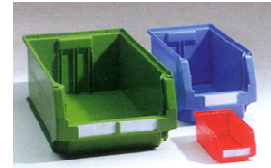

CONTENANTS SEMI-OUVERTS

SEMI-OPEN FRONT CONTAINERS

CODE DE REF.	LONG. X LARG. X HAUT.	BLEU	ROUGE	JAUNE	VERT
REF. CODE	DEEP X WIDTH X HIGH	BLUE	RED	YELLOW	GREEN
LF-110	3.8" X 4.0" X 2.0"	QB600110	QB600111	QB600112	QB600114
LF-211	6.5" X 4.3" X 3.0"	QB600211	QB600212	Égarage	QB600214
LF-221	9.2" X 5.9" X 4.8"	QB600221	QB600222	QB600223	QB600224
LF-321	13.6" X 8.3" X 5.8"	QB600321			
LF-322	13.6" X 8.3" X 7.9"	QB600322	QB600323	QB600324	QB600325
LF-532	19.7" X 12.3" X 7.9"	QB600532			

SÉPARATEURS

DIVIDERS

CODE DE REF.	NOTRE CODE	DESCRIPTION
REF. CODE	OUR CODE	DESCRIPTION
ZW-211	QB6ZW211	SÉPARATEUR POUR BOITE 211
ZW-221	QB6ZW221	SÉPARATEUR POUR BOITE 221
ZW-321	QB6ZW321	SÉPARATEUR POUR BOITE 321
ZW-322	QB6ZW322	SÉPARATEUR POUR BOITE 322

PANNEAUX MURAUX POUR CONTENANTS LF

LOUVERED PANELS

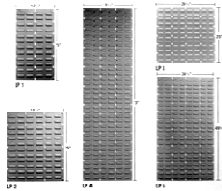

CODE DE REF.	NOTRE CODE	DESCRIPTION
REF. CODE	OUR CODE	DESCRIPTION
LP1	QB600LP1	12 3/4 W X 25" H
LP2	QB600LP2	18 3/4 W X 25" H
LP3	*****	24 3/4 W X 25" H
LP4	QB600LP4	18 3/4 W X 73" H
LP5	QB600LP5	24 3/4 W X 49 3/4 H

QUANTITÉ DE CONTENANTS LF POUR COUVRIR LES PANNEAUX PERFORÉS /

NUMBER OF LF CONTAINERS PER PANEL

PANNEAU PANEL	LF110	LF211	LF221	LF321	LF322
LP 1	18	18	8	***	***
LP 2	24	24	12	6	4
LP 3	36	36	16	9	6
LP 4	72	72	36	18	12
LP 5	72	72	32	18	18
	LF341	LF531	LF532		
LP 1	***	3	2		
LP 2	5	***	***		
LP 3	***	6	4		
LP 4	10	***	***		
LP 5	6	12	8		

COFFRETS ET CABINETS

CABINETS AND BOLT BINS

COFFRETS

DRAWERS



MODÈLES / MODEL				
SPECIFICATIONS	107	102	111	ADJUSTABLE / ADJUSTABLE 119
LARGEUR(PO) / WIDTH(IN)	18	18	18	18
HAUTEUR(PO) / HEIGTH(IN)	3	3	3	3
PROFOND.(PO) / DEPTH(IN)	12	12	12	12
COULEUR / COLOR	GRIS FONCÉ / GRAY BAKED ENAMEL			
NB.OF COMPARTIMENTS	32	24	20	VARIABLE

CABINETS À COFFRETS

DRAWER SLIDE CABINETS

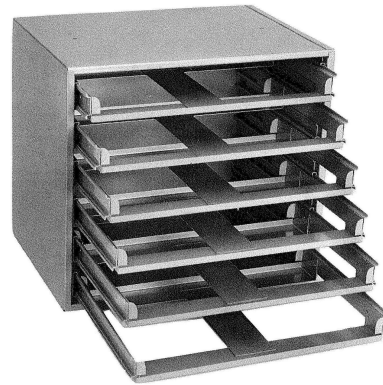
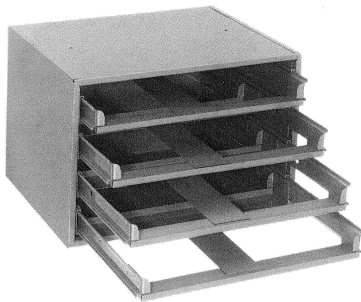

MODÈLES / MODEL			
SPECIFICATIONS	307	308	
LARGEUR(PO) / WIDTH(IN)	15 1/4	15 1/4	
HAUTEUR(PO) / HEIGTH(IN)	11 1/4	16 3/8	
PROFOND.(PO) / DEPTH(IN)	11 3/4	11 3/4	
COULEUR / COLOR	GRIS FONCÉ / GRAY BAKED ENAMEL		
NB.OF DRAWERS	4	6	



Tel.: (819) 346-2903 / (888) 345-2903 Fax.: (819) 346-3389

Email: distributeur@boulonsestrie.com

H-19

CABINETS

BINS

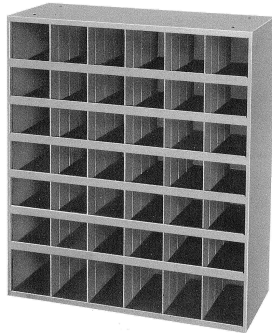

MODÈLE / MODEL		
SPECIFICATIONS	360	363
LARGEUR(PO) / WIDTH(IN)	33 3/4	33 3/4
HAUTEUR(PO) / HEIGTH(IN)	42	42
PROFOND.(PO) / DEPTH(IN)	12	12
COULEUR / COLOR : GRIS FONCÉ / GRAY BAKED ENAMEL		
NO.OF BINS	42	72
LARGEUR BIN WIDTH(IN)	5 3/8	4
HAUTEUR BIN HEIGHT (IN)	5 1/2	4 1/2
PROFONDEUR BIN DEPTH(IN)	11 7/8	11 7/8

AUSSI DISPONIBLE / ALSO AVAILABLE

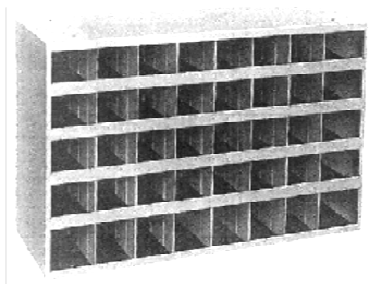

40 COMPARTIMENTS / 40 BINS
36" W X 24" H X 12" D
DIM. COMP. / BIN SIZE: 4 1/2 X 4 1/2 X 12
NOTRE CODE / OUR CODE: CO123040

CABINETS À TIROIRS

DRAWER CABINETS

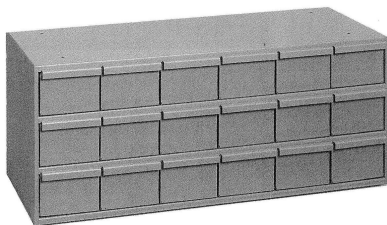

MODÈLE / MODEL		
SPECIFICATIONS	005	007
LARGEUR(PO) / WIDTH(IN)	33 3/4	33 3/4
HAUTEUR(PO) / HEIGTH(IN)	10 7/8	14 3/8
PROFOND.(PO) / DEPTH(IN)	11 5/8	11 5/8
COULEUR / COLOR : GRIS FONCÉ / GRAY BAKED ENAMEL		
NO.OF DRAWERS	18	24
LARGEUR DRAWER WIDTH(IN)	5 3/8	5 3/8
HAUTEUR DRAWER HEIGHT	2 3/4	2 3/4
PROFONDEUR DRAWER DEPTH	11 1/4	11 1/4
SEPARAT. DRAWER DIVIDERS	36	48



Tel.: (819) 346-2903 / (888) 345-2903 Fax.: (819) 346-3389

Email: distributeur@boulonsestrie.com

H-20

CABINET TOUT-USAGE

MULTI-PURPOSE BIN

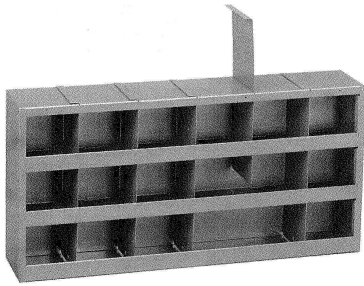

MODÈLE / MODEL		
SPECIFICATIONS	319	
LARGEUR(PO) / WIDTH(IN)	23 3/4	
HAUTEUR(PO) / HEIGTH(IN)	12 1/4	
PROFOND.(PO) / DEPTH(IN)	4 3/4	
COULEUR / COLOR : GRIS FONCÉ / GRAY BAKED ENAMEL		
NO.OF BINS	18	
LARGEUR BIN WIDTH (IN)	3 7/8	
HAUTEUR BIN HEIGHT (IN)	3 3/4	
PROFONDEUR BIN DEPTH(IN)	4 5/8	

CLASSEUR À TIGES

RODS CABINET

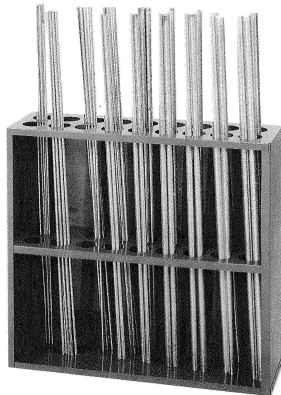

MODÈLE / MODEL		
SPECIFICATIONS	367	
LARGEUR(PO) / WIDTH(IN)	24 1/8	
HAUTEUR(PO) / HEIGTH(IN)	24	
PROFOND.(PO) / DEPTH(IN)	6 7/8	
COULEUR / COLOR : GRIS FONCÉ / GRAY BAKED ENAMEL		
NO.OF SECTIONS	18	



Tel.: (819) 346-2903 / (888) 345-2903 Fax.: (819) 346-3389

Email: distributeur@boulonsestrie.com

COFFRETS ET CABINETS

CABINETS AND BOLT BINS

COFFRETS

DRAWERS



MODÈLE / MODEL				
SPECIFICATIONS	107	102	111	AJUSTABLE / ADJUSTABLE 119
LARGEUR(PO) / WIDTH(IN)	18	18	18	18
HAUTEUR(PO) / HEIGHT(IN)	3	3	3	3
PROFOND.(PO) / DEPTH(IN)	12	12	12	12
COULEUR / COLOR	GRIS FONCÉ / GRAY BAKED ENAMEL			
NB.OF COMPARTIMENTS	32	24	20	VARIABLE

CABINETS À COFFRETS

DRAWER SLIDE CABINETS

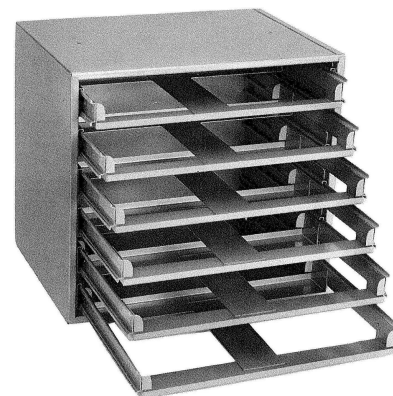
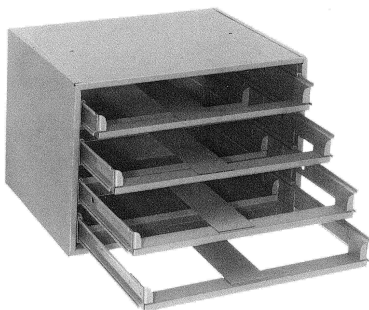

MODÈLE / MODEL		
SPECIFICATIONS	307	308
LARGEUR(PO) / WIDTH(IN)	15 1/4	15 1/4
HAUTEUR(PO) / HEIGHT(IN)	11 1/4	16 3/8
PROFOND.(PO) / DEPTH(IN)	11 3/4	11 3/4
COULEUR / COLOR	GRIS FONCÉ / GRAY BAKED ENAMEL	
NB.OF DRAWERS	4	6



Tel.: (819) 346-2903 / (888) 345-2903 Fax.: (819) 346-3389

Email: distributeur@boulonsestrie.com

CABINETS

BINS

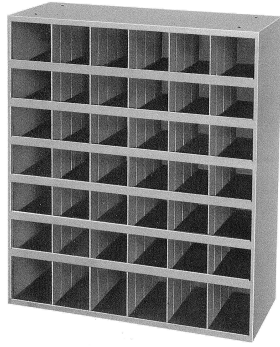

MODÈLE / MODEL		
SPECIFICATIONS	360	363
LARGEUR(PO) / WIDTH(IN)	33 3/4	33 3/4
HAUTEUR(PO) / HEIGHT(IN)	42	42
PROFOND.(PO) / DEPTH(IN)	12	12
COULEUR / COLOR :	GRIS FONCÉ / GRAY BAKED ENAMEL	
NO.OF BINS	42	72
LARGEUR BIN WIDTH(IN)	5 3/8	4
HAUTEUR BIN HEIGHT (IN)	5 1/2	4 1/2
PROFONDEUR BIN DEPTH(IN)	11 7/8	11 7/8

AUSSI DISPONIBLE / ALSO AVAILABLE

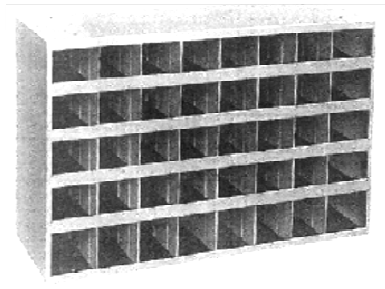

➔ *VIDE / EMPTY* ➔

<p>40 COMPARTIMENTS / 40 BINS 36" W X 24" H X 12" D DIM. COMP. / BIN SIZE: 4 1/2 X 4 1/2 X 12 NOTRE CODE / OUR CODE: CO123040</p>
--

CABINETS À TIROIRS

DRAWER CABINETS

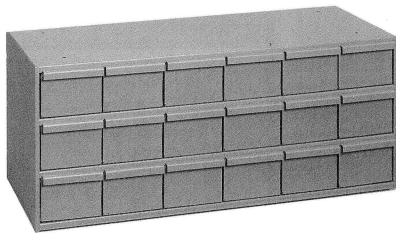

MODÈLE / MODEL		
SPECIFICATIONS	005	007
LARGEUR(PO) / WIDTH(IN)	33 3/4	33 3/4
HAUTEUR(PO) / HEIGHT(IN)	10 7/8	14 3/8
PROFOND.(PO) / DEPTH(IN)	11 5/8	11 5/8
COULEUR / COLOR :	GRIS FONCÉ / GRAY BAKED ENAMEL	
NO.OF DRAWERS	18	24
LARGEUR DRAWER WIDHT(IN)	5 3/8	5 3/8
HAUTEUR DRAWER HEIGHT	2 3/4	2 3/4
PROFONDEUR DRAWER DEPTH	11 1/4	11 1/4
SEPARAT. DRAWER DIVIDERS	36	48



Tel.: (819) 346-2903 / (888) 345-2903 Fax.: (819) 346-3389

Email: distributeur@boulonsestrie.com

COFFRETS ET CABINETS

CABINETS AND BOLT BINS

CABINET TOUT-USAGE

MULTI-PURPOSE BIN

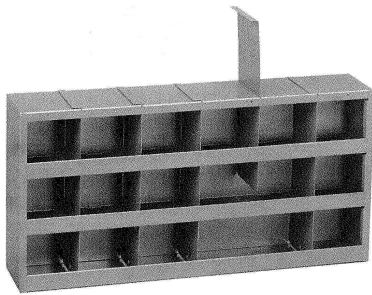

MODÈLE / MODEL	
SPECIFICATIONS	319
LARGEUR(PO) / WIDTH(IN)	23 3/4
HAUTEUR(PO) / HEIGHT(IN)	12 1/4
PROFOND.(PO) / DEPTH(IN)	4 3/4
COULEUR / COLOR :	GRIS FONCÉ / GRAY BAKED ENAMEL
NO.OF BINS	18
LARGEUR BIN WIDHT (IN)	3 7/8
HAUTEUR BIN HEIGHT (IN)	3 3/4
PROFONDEUR BIN DEPTH(IN)	4 5/8

CLASSEUR À TIGES

RODS CABINET

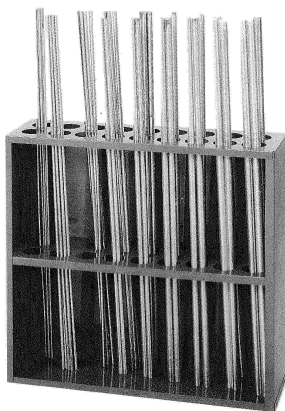

MODÈLE / MODEL	
SPECIFICATIONS	367
LARGEUR(PO) / WIDTH(IN)	24 1/8
HAUTEUR(PO) / HEIGHT(IN)	24
PROFOND.(PO) / DEPTH(IN)	6 7/8
COULEUR / COLOR :	GRIS FONCÉ / GRAY BAKED ENAMEL
NO.OF SECTIONS	18

















Tel.: (819) 346-2903 / (888) 345-2903 Fax.: (819) 346-3389

Email: distributeur@boulonsestrie.com

SECTION I















CÂBLE, CHÂÎNE ET ACCESSOIRES CABLE, CHAIN AND ACCESSORIES

INFORMATION TECHNIQUE.....DÉBUT DE LA SECTION
TECHNICAL INFORMATION.....BEGINNING OF THIS SECTION

	DESCRIPTION	SECTION-PAGE
	CÂBLE D'AVIATION GALVANISÉ. GALVANIZED AIRCRAFT CABLE .	I-1
	CÂBLE D'AVIATION ACIER INOXYDABLE. STAINLESS STEEL AIRCRAFT CABLE .	I-2
	SERRE-CÂBLES GALVANISÉS. GALVANIZED MALLEABLE CLIPS.	I-2
	COSES À CÂBLE GALVANISÉS. GALVANIZED THIMBLES.	I-3
	BAGUES OVALES ALUMINIUM. ALUMINUM OVAL SLEEVES.	I-3
	BAGUES D'ARRÊT EN ALUMINIUM. ALUMINUM STOP SLEEVES.	SUR DEMANDE ON REQUEST
	EMBOUTISSEURS MANUELS. HAND SWAGERS.	I-4
	TENDEURS. TURNBUCKLES.	I-5
	CHÂÎNE EN ROULEAU. CHAIN ON REEL.	I-6
	CHÂÎNE À MAILLONS TORSADÉS. TWIST LINKS MACHINE CHAIN.	I-6
	CHÂÎNE À MAILLONS BLOQUÉS "TENSO". COIL CHAIN "TENSO".	I-6
	CHÂÎNE À CHASSIS. SASH CHAIN.	I-6
	CHÂÎNE À MAILLONS ORDINAIRES, GRADE 30. PROOF COIL CHÂÎNE , GRADE 30.	I-7
	CHÂÎNE DE TRANSPORT, GRADE 70 . TRANSPORT CHAIN, GRADE 70.	I-7





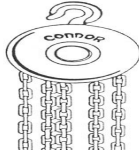
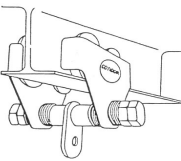







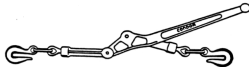

SECTION I

CÂBLE, CHÂÎNE ET ACCESSOIRES CABLE, CHAIN AND ACCESSORIES

	DESCRIPTION	SECTION-PAGE
	CHAÎNE DE LEVAGE, GRADE 80. ALLOY LIFTING CHAINE, GRADE 80.	I-7
	COUPE BOULONS. BOLT CUTTERS.	I-8
	CROCHETS GRAPPINS À MANILLE, GRADE 30. CLEVIS GRAB HOOKS, GRADE 30.	I-9
	CROCHETS GRAPPINS À MANILLE, GRADE 70. CLEVIS GRAB HOOKS, GRADE 70.	I-9
	CROCHETS GRAPPINS À ŒIL, GRADE 30. EYE TYPE GRAB HOOKS, GRADE 30.	I-9
	CROCHETS COULISSANTS À MANILLE, GRADE 30. CLEVIS SLIP HOOKS, GRADE 30.	I-10
	CROCHETS COULISSANTS À MANILLE, GRADE 70. CLEVIS SLIP HOOKS, GRADE 70.	I-10
	CROCHETS COULISSANTS À ŒIL, GRADE 30. EYE TYPE SLIP HOOKS, GRADE 30.	I-10
	CROCHETS À ŒIL AVEC LINGUETS DE SÉCURITÉ. EYE HOOKS WITH SECURITY LATCH.	I-11
	LINGUETS. LATCHES.	I-11
	CROCHETS COULISSANTS À MANILLE, GRADE 70. CLEVIS SLIP HOOKS, GRADE 70.	I-11
	CROCHETS GRAPPINS À MANILLE, GRADE 70. CLEVIS GRAB HOOKS, GRADE 70.	I-12
	CROCHETS GRAPPINS À MANILLE, GRADE 80. CLEVIS GRAB HOOKS, GRADE 80.	I-12
	CROCHETS COULISSANTS D'ÉLINGUE À MANILLE. CLEVIS CHAIN SLIP HOOKS.	I-12
	PALANS À CHAÎNE / CHARIOTS. CHAIN BLOCK / TROLLEYS.	I-13
		



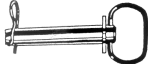











SECTION I

CÂBLE, CHÂÎNE ET ACCESSOIRES CABLE, CHAIN AND ACCESSORIES

DESCRIPTION	SECTION-PAGE	
	MANILLES D'ANCRAGE. CLEVIS SCREWS.	I-14
	MAILLONS À RIVET. RIVET LINKS.	I-16
	MAILLONS RAPIDES . QUICK LINKS.	I-16
	MAILLONS FROIDS. STEEL COLD SHUT.	SUR DEMANDE ON REQUEST
	MAILLONS FENDUS. SPLIT REPAIR LINKS.	SUR DEMANDE ON REQUEST
	MAILLONS JUMEAUX. MID LINKS.	SUR DEMANDE ON REQUEST
	ATTACHES DE CHARGE . LOAD BINDERS.	I-8
	ELINGUES DE CHÂÎNE. CHAIN SLINGS.	SUR DEMANDE ON REQUEST
	ÉMÉRILLONS EN FONTE MALLÉABLE, <u>ZINC.</u> MALLEABLE IRON CHAIN SWIVEL, <u>PLATED.</u>	SUR DEMANDE ON REQUEST
	GOUPILLES D'ATTACHE . LINCH PINS.	I-17
	ANNEAUX À CLÉ. KEY RINGS.	I-17
	ANNEAUX SOUDÉS. STEEL RINGS.	I-32
	GOUPILLES D'ATELAGE. HITCH PINS.	I-17
	TENDEURS DIVERS. TURNBUCKLES.	I-19
	PITONS AVEC ÉCROUS. EYE BOLTS & NUTS.	I-20

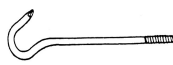
SECTION I

CÂBLE, CHÂÎNE ET ACCESSOIRES CABLE, CHAIN AND ACCESSORIES

DESCRIPTION	SECTION-PAGE
	<p>PITONS À BOIS, TIRE-FONDS. EYE LAG BOLTS.</p> <p style="text-align: right;">I-22</p>
	<p>"A" SUITE , PETIT ŒILLETS À VIS . SCREW EYES "A" SUIT.</p> <p style="text-align: right;">I-21</p>
	<p>"B" SUITE ,ŒILLETS À VIS MÉDIUM. MEDIUM SCREW EYES "B" SUIT.</p> <p style="text-align: right;">I-21</p>
	<p>CROCHETS POUR TABLEAUX. PICTURE HANGERS.</p> <p style="text-align: right;">I-23</p>
	<p>CROCHETS EN "S". "S" HOOKS.</p> <p style="text-align: right;">I-23</p>
	<p>"M" SUIT CROCHETS VIS. SCREW HOOKS "M" SUIT.</p> <p style="text-align: right;">I-23</p>
	<p>CROCHETS DE CORNICHE. CORNICHE HOOKS.</p> <p style="text-align: right;">I-24</p>
	<p>CROCHETS DE TASSE, LAITON. BRASS SCREW (SHOULDER) HOOKS.</p> <p style="text-align: right;">I-24</p>
	<p>CROCHETS DE TASSE, LAITON. CUP BRASS HOOKS.</p> <p style="text-align: right;">I-24</p>
	<p>CROCHETS DE PORTE À ŒILLETS À VIS. GATE HOOKS AND SCREW EYES.</p> <p style="text-align: right;">I-24</p>
	<p>CROCHETS DE CORDE À LINGE. CLOTHE LINE HOOKS.</p> <p style="text-align: right;">SUR DEMANDE ON REQUEST</p>
	<p>BOULONS À ANNEAU AVEC ÉCROUS. RING BOLTS AND NUTS.</p> <p style="text-align: right;">I-25</p>
	<p>ANNEAUX D'ACCROCHAGE À BOIS. HITCHING RING (LAG THREAD).</p> <p style="text-align: right;">I-25</p>
	<p>ANNEAUX D'ACCROCHAGE (AVEC PLAQUE). HITCHING RINGS (PLATE STYLE).</p> <p style="text-align: right;">I-25</p>
	<p>MOUSQUETONS DIVERS. VARIOUS SNAPS.</p> <p style="text-align: right;">I-26</p>

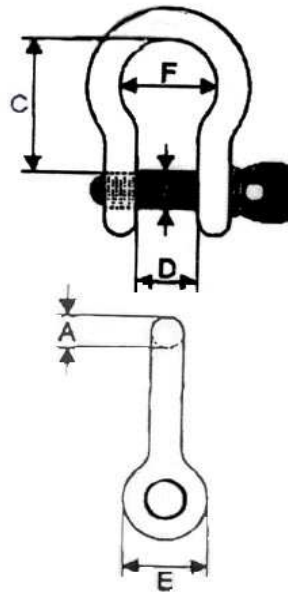

DIMENSION	CHARGE ADM.	DIAM. TIGE	DIMENSIONS (POUCES)			
SIZE	WLL	PIN DIAMETER	DIMENSIONS (INCHES)			
(A)	(TONNE/TON)		C	D	E	F
3/16	1/3	1/4	0,88	0,38	0,56	0,63
1/4	1/2	5/16	1,06	0,47	0,66	0,75
5/16	3/4	3/8	1,25	0,53	0,81	0,84
3/8	1	7/16	1,44	0,63	0,97	1,00
7/16	1 1/2	1/2	1,69	0,75	1,06	1,13
1/2	2	5/8	1,88	0,81	1,31	1,25
5/8	3 1/4	3/4	2,44	1,06	1,56	1,69
3/4	4 3/4	7/8	2,88	1,19	1,88	1,94
7/8	6 1/2	1	3,38	1,44	2,13	2,19
1	8 1/2	1 1/8	3,81	1,69	2,38	2,63
1 1/8	9 1/2	1 1/4	4,25	1,75	2,63	2,88
1 1/4	12	1 3/8	4,69	2,00	3,00	3,13
1 3/8	13 1/2	1 1/2	5,31	2,13	3,25	3,50
1 1/2	17	1 5/8	5,69	2,31	3,50	3,75
1 3/4	25	2	7,06	2,88	4,25	4,88
2	35	2 1/4	7,75	3,31	4,88	5,44



Tel.: (819) 346-2903 / (888) 345-2903 Fax.: (819) 346-3389

Email: distributeur@boulonsestrie.com



CLASSIFICATION 7 X 19

NOTRE CODE	DESCRIPTION	RÉSISTANCE À LA RUPTURE	
OUR CODE	DESCRIPTION	BREAKING STRENGTH	
*****	1/16	480	LBS
CH200093	3/32	1000	LBS
CH200094	3/32 X 250'	1000	LBS
CH200095	3/32 X 500'	1000	LBS
CH200096	3/32 X 1000'	1000	LBS
CH200125	1/8	2000	LBS
CH200126	1/8 X 250'	2000	LBS
CH200127	1/8 X 500'	2000	LBS
CH200128	1/8 X 1000'	2000	LBS
*****	5/32	2800	LBS
CH200187	3/16	4200	LBS
CH200188	3/16 X 250'	4200	LBS
CH200189	3/16 X 500'	4200	LBS
CH200190	3/16 X 1000'	4200	LBS
*****	7/32	5600	LBS
CH200250	1/4 x 100'	7000	LBS
CH200251	1/4 X 250'	7000	LBS
CH200252	1/4 X 500'	7000	LBS
CH200253	1/4 X 1000'	7000	LBS
CH200315	5/16	9800	LBS
CH200316	5/16 X 250'	9800	LBS
CH200317	5/16 X 500'	9800	LBS
CH200318	5/16 X 1000'	9800	LBS
CH200375	3/8	14400	LBS
CH200376	3/8 X 150'	14400	LBS
CH200377	3/8 X 250'	14400	LBS
CH200378	3/8 X 500'	14400	LBS
CH200379	3/8 X 1000'	14400	LBS

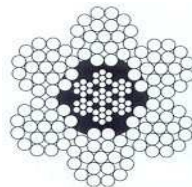

CLASSIFICATION 6 X 19

NOTRE CODE	DESCRIPTION	RÉSISTANCE À LA RUPTURE	
OUR CODE	DESCRIPTION	BREAKING STRENGTH	
CH200500	1/2	20700	LBS
CH200501	1/2 X 250'	20700	LBS
CH200502	1/2 X 500'	20700	LBS

CÂBLE D'AVIATION
 ACIER INOXYDABLE
 *** 304 ***



AIRCRAFT CABLE
 STAINLESS STEEL
 *** 304 ***

CLASSIFICATION 7 X 19

NOTRE CODE	DESCRIPTION	RÉSISTANCE À LA RUPTURE	
OUR CODE	DESCRIPTION	BREAKING STRENGTH	
*****	1/16	480	LBS
*****	3/32	1100	LBS
CH201125	1/8	1700	LBS
*****	5/32	2900	LBS
CH201187	3/16	3700	LBS
*****	7/32	5000	LBS
CH201250	1/4	6400	LBS
*****	5/16	9400	LBS
CH201375	3/8	12000	LBS

**AUSSI DISPONIBLE / ALSO AVAILABLE:
 ACIER INOXYDABLE 316 / STAINLESS STEEL 316**

SERRE-CÂBLES
 GALVANISÉS



GALVANIZED
 MALLEABLE CLIPS

NOTRE CODE	DIMENSION	AUSSI DISPONIBLE / ALSO AVAILABLE :
OUR CODE	DIMENSION	
CH300125	1/8	ACIER INOXYDABLE 304 & 316 STAINLESS STEEL 304 & 316
CH300187	3/16	
CH300250	1/4	
CH300315	5/16	
CH300375	3/8	
*****	7/16	
CH300500	1/2	
CH300625	5/8	
CH300750	3/4	
CH300875	7/8	
CH301000	1	



Tel.: (819) 346-2903 / (888) 345-2903 Fax.: (819) 346-3389
 Email: distributeur@boulonsestrie.com

**COSSES À CÂBLE STANDARDS
GALVANISÉES**



**STANDARD THIMBLES
GALVANIZED**

NOTRE CODE	DIMENSION
OUR CODE	DIMENSION
CH400125	1/8
CH400187	3/16
CH400250	1/4
CH400315	5/16
CH400375	3/8
CH400500	1/2
*****	5/8
CH400750	3/4
*****	7/8

BAGUES OVALES EN ALUMINIUM

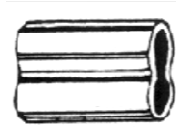

ALUMINUM OVAL SLEEVES

NOTRE CODE	DIMENSION
OUR CODE	DIMENSION
CH140876	1/16
CH140877	1/8
CH140878	3/16
CH140879	1/4
CH140880	5/16
CH140881	3/8
CH140883	1/2

**SUR DEMANDE /
ON REQUEST**



**BAGUES D'ARRÊT EN ALUMINIUM
ALUMINUM STOP SLEEVES**

**NOUS POUVONS VOUS FOURNIR TOUTE LA GAMME
D'ACCESSOIRES SE RAPPORTANT AU CÂBLE D'ACIER /
WE CAN SUPPLY YOU ALL THE STEEL CABLE ACCESSORIES**



**Tel.: (819) 346-2903 / (888) 345-2903 Fax.: (819) 346-3389
Email: distributeur@boulonsestrie.com**

OU000HS5

**EMBOUTISSOIR À MULTICOMPRESSION MUNI D'UN COUPE-CÂBLE
MULTICOMPRESSION HAND SWAGER WITH CABLE CUTTER
LONGUEUR / LENTH : 28"**

POUR BAGUES OVALES / FOR OVAL SLEEVES	POUR BAGUES D'ARRÊT / FOR STOP SLEEVES
1/16 - 3/32 - 1/8 - 5/32 - 3/16	1/16 - 3/32 - 1/8 - 5/32 - 3/16 - 7/32

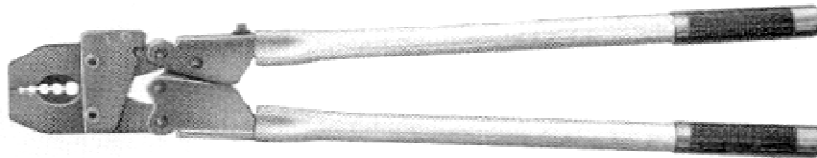

**EMBOUTISSOIR À MAIN, 1 CAVITÉ (REF. HS-1B)
HAND SWAGER, 1 CAVITY (REF. HS-1B)
LONGUEUR / LENTH : 20"**

DISPONIBLE POUR: POUR BAGUES OVALES / FOR OVAL SLEEVES	POUR BAGUES D'ARRÊT / AVAILABLE FOR: FOR STOP SLEEVES
7/32 OU 1/4 OU 9/32 OU 5/16	1/4 - 9/32 - 5/16

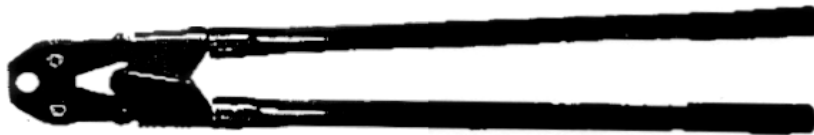

**PETIT EMBOUTISSOIR MANUEL COMPACT
SMALL AND COMPACT HAND SWAGER
LONGUEUR / LENTH : 9"**

POUR BAGUES OVALES / FOR OVAL SLEEVES	POUR BAGUES D'ARRÊT / FOR STOP SLEEVES
1/32 - 3/64 - 1/16	1/32 - 3/64 - 1/16

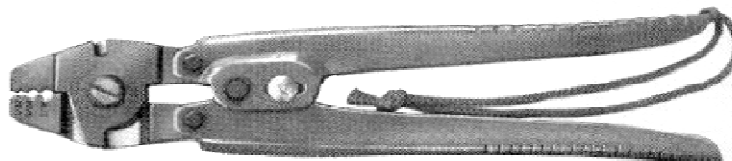

TENDEURS
GALVANISÉS,
ACIER FORGÉ

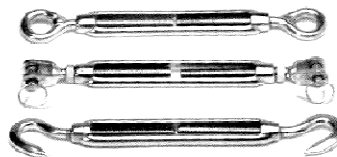

TURNBUCKLES
GALVANIZED
DROP-FORGED

DIMENSION	ŒIL & ŒIL	CROCHET ET CROCHET	MÂCHOIR & MÂCHOIR
DIMENSION	EYE & EYE	HOOK & HOOK	JAW & JAW
DIAMÈTRE X AJUSTEMENT	CHARGE ADM. (LBS)	CHARGE ADM. (LBS)	CHARGE ADM. (LBS)
DIAMETER X TAKE UP	ADM. CHARGE (LBS)	ADM. CHARGE (LBS)	ADM. CHARGE (LBS)
3/8 X 6	1200	1000	1200
1/2 X 6	2200	1500	2200
1/2 X 9	2200	1500	2200
1/2 X 12	2200	1500	2200
5/8 X 6	3500	2250	3500
5/8 X 9	3500	2250	3500
5/8 X 12	3500	2250	3500
3/4 X 6	5200	3000	5200
3/4 X 9	5200	3000	5200
3/4 X 12	5200	3000	5200
3/4 X 18	5200	3000	5200
7/8 X 12	7200	4000	7200
7/8 X 18	7200	4000	7200
1 X 12	10000	5000	10000
1 X 18	10000	5000	10000
1 X 24	10000	5000	10000
1 1/4 X 12	15200	5000	15200
1 1/4 X 18	15200	5000	15200
1 1/2 X 12	21400	7500	21400
1 1/2 X 18	21400	7500	21400

TENDEURS
À ERGOT



TURNBUCKLES
ROD END

DIAMÈTRE X AJUSTEMENT	CHARGE ADM. (LBS)
DIAMETER X TAKE UP	ADM. CHARGE (LBS)
3/8 X 6	1200
1/2 X 6	2200
5/8 X 6	3500
3/4 X 6	5200
7/8 X 6	7200
1 X 6	10000

CORPS SEULEMENT EST DISPONIBLE / BODY ONLY IS AVAILABLE
AUTRES DIMENSIONS DISPONIBLE / OTHER DIMENSIONS ARE AVAILABLE

CHAÎNE EN ROULEAU
CHAÎNE À MAILLONS
ORDINAIRES
ZINC

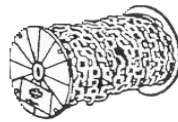

CHAIN ON REEL
PROOF COIL CHAIN
PLATED

GRADE 30

NOTRE CODE	DIMENSION	QTÉ/ROULEAU	EFFORT ADMISSIBLE, LBS
OUR CODE	DIMENSION	QTY/ROLL	SAFE WORKING LOAD, LBS
*****	1/8	198'	300
*****	5/32	98'	375
CH141044	3/16	98'	630
CH141045	1/4	98'	1100
CH141046	5/16	75'	1700
CH141047	3/8	49'	2400

CHAÎNE À MAILLONS TORSADÉS
ZINC

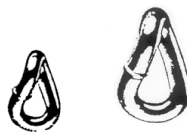

TWIST LINKS MACHINE CHAIN
PLATED

NOTRE CODE	NO - (DIA. FIL)	QTÉ/ROULEAU	EFFORT ADMISSIBLE, LBS
OUR CODE	NO - (WIRE DIA.)	QTY/ROLL	SAFE WORKING LOAD, LBS
CH141043	4 - (1/8")	98'	200
*****	2 - (5/32")	98'	287
CH141042	2/0 - (3/16")	75'	520

CHAÎNE À MAILLONS BLOQUÉS
"TENSO"
ZINC



COIL CHAIN
"TENSO"
PLATED

NOTRE CODE	NO - (DIA. FIL)	QTÉ/ROULEAU	EFFORT ADMISSIBLE, LBS
OUR CODE	NO - (WIRE DIA.)	QTY/ROLL	SAFE WORKING LOAD, LBS
*****	4 - (.079")	197'	70
*****	3 - (.080")	197'	90
CH141049	1 - (.103")	98'	155
*****	2/0 - (.135")	180'	255

CHAÎNE À CHASSIS
ZINC



SASH CHAIN
PLATED

NOTRE CODE	DIMENSION	QTÉ/ROULEAU	EFFORT ADMISSIBLE, LBS
OUR CODE	DIMENSION	QTY/ROLL	SAFE WORKING LOAD, LBS
*****	8	197'	75
CH141048	80 OU /OR 35	98'	106

CHAÎNE À MAILLONS
ORDINAIRES
GRADE 30

PROOF COIL
CHAIN
GRADE 30



ZINC / PLATED

NOTRE CODE	DIMENSION	CHARGE ADM. LBS	POIDS APPROX / 100 PI. LBS
OUR CODE	DIMENSION	LOAD LIMIT. LBS	APPROX WEIGHT / 100 FT. LBS
CH141019	1/8	300 lbs	20.39
CH141025	3/16	630 lbs	39.35
CH141030	1/4	1100 lbs	63.60
CH141035	5/16	1900 lbs	100.62
CH141040	3/8	2650 lbs	145.63
CH141041	1/2	4500 lbs	263.68

GALVANISÉ ET ACIER NOIR DISPONIBLE / GALVANIZED AND BARE STEEL IS AVAILABLE

ATTENTION: LES CHAÎNES GRADE 30 NE SONT PAS CONÇUES POUR DES APPLICATIONS DE LEVAGE.

CHAÎNE DE TRANSPORT
GRADE 70

TRANSPORT CHAIN
GRADE 70

PLAQUÉE AU CHROMATE JAUNE / CHROMATE YELLOW PLATED

NOTRE CODE	DIMENSION	CHARGE ADM. LBS	POIDS APPROX / 100 PI. LBS
OUR CODE	DIMENSION	LOAD LIMIT. LBS	APPROX WEIGHT / 100 FT. LBS
CH141050	1/4	3150 lbs	61.47
CH141060	5/16	4700 lbs	93.95
CH141065	3/8	6600 lbs	145.62
CH141066	1/2	11300 lbs	263.68

ATTENTION: LES CHAÎNES GRADE 70 NE SONT PAS CONÇUES POUR DES APPLICATIONS DE LEVAGE.

CHAÎNE DE LEVAGE EN ACIER ALLIÉ
GRADE 80

ALLOY LIFTING CHAIN
GRADE 80

NOTRE CODE	DIMENSION	CHARGE ADM. LBS	POIDS APPROX / PI. LBS
OUR CODE	DIMENSION	LOAD LIMIT. LBS	APPROX WEIGHT / FT. LBS
*****	9/32	3500	.71
*****	3/8	7100	.144
*****	1/2	12000	.236
*****	5/8	18100	.380
*****	3/4	28300	.556

COUPE-BOULONS / BOLT CUTTERS

COUPE-BOULONS
À COUPE CENTRALE

BOLT CUTTERS FOR
CENTRAL CUT

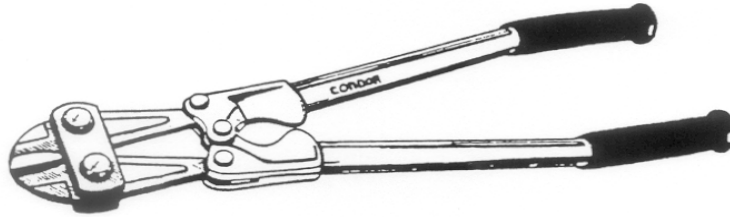

NOTRE CODE	LONGUEUR	CAP. COUPE
OUR CODE	LENGTH	CUTTING CAP.
OU00BC10	18"	5/16
*****	24"	3/8
*****	36"	5/8

JEU DE MACHOÎRES
AVEC PLAQUE

REPLACEMENT SET OF
JAWS WITH PLATES

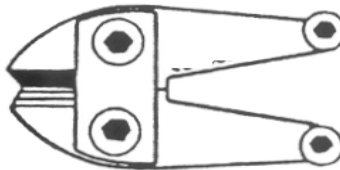

NOTRE CODE	LONGUEUR	EMB.
OUR CODE	LENGTH	PACK
*****	18"	1
*****	24"	1
*****	36"	1

ATTACHES DE CHARGE

LOAD BINDERS

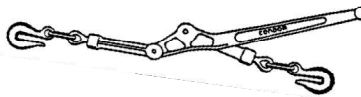

NO. CODE	CAP. CHAÎNE	OUVERTURE	LONGUEUR LEVIER	EFFORT ADM.	RESIS. À LA RUPTURE
OUR CODE	CHAIN CAP.	OPEN SPREAD	LEVER LENGTH	SAFE WORKING	BREAKING STRENGTH
CH141070	1/4"	15-1/2"	13"	1250 LB	5 300 LB
CH141071	5/16" - 3/8"	22-1/2"	16"	5400 LB	19 000 LB
*****	3/8" - 1/2"	28-1/2"	18-1/2"	9200 LB	33 000 LB



Tel.: (819) 346-2903 / (888) 345-2903 Fax.: (819) 346-3389

Email: distributeur@boulonsestrie.com

CROCHETS FORGÉS POUR CHAÎNE / FORGED CHAIN HOOKS

**CROCHETS GRAPPIN
A MANILLE**



**CLEVIS GRAB
HOOKS**

GRADE 30

ACIER AU CARBONE COULEUR GRIS / CARBON STEEL COLOUR GREY

NOTRE CODE	DESCRIPTION	CHARGE AMD. (lbs)
OUR CODE	DESCRIPTION	SAFE WORKING LOAD
CH140330	1/4	2600
CH140340	5/16	3900
CH140350	3/8	5400
CH140360	7/16	7200
CH140370	1/2	9200

GRADE 70

ACIER D'ALLIAGE DE CHROMATE JAUNE / CHROMATE YELLOW STEEL PLATED

NOTRE CODE	DESCRIPTION	CHARGE AMD. (lbs)
OUR CODE	DESCRIPTION	SAFE WORKING LOAD
CH140335	1/4	3150
CH140345	5/16	4700
CH140355	3/8	6600
CH140361	7/16	8800
*****	1/2	11300

**CROCHETS
GRAPPIN A CEIL**



**EYE TYPE
GRAB HOOKS**

GRADE 30

ACIER AU CARBONE COULEUR GRIS / CARBON STEEL COLOUR GREY

NOTRE CODE	DESCRIPTION	CHARGE AMD. (lbs)
OUR CODE	DESCRIPTION	SAFE WORKING LOAD
*****	1/4	2600
*****	5/16	3900
*****	3/8	5400

CROCHETS FORGÉS POUR CHAÎNE / FORGED CHAIN HOOKS

CROCHETS GRAPPIN
À MANILLE



CLEVIS GRAB
HOOKS

GRADE 30

ACIER AU CARBONE COULEUR GRIS / CARBON STEEL COLOUR GREY

NOTRE CODE	DESCRIPTION	CHARGE AMD. (lbs)
OUR CODE	DESCRIPTION	SAFE WORKING LOAD
CH140330	1/4	2600
CH140340	5/16	3900
CH140350	3/8	5400
CH140360	7/16	7200
CH140370	1/2	9200

GRADE 70

ACIER D'ALLIAGE DE CHROMATE JAUNE / CHROMATE YELLOW STEEL PLATED

NOTRE CODE	DESCRIPTION	CHARGE AMD. (lbs)
OUR CODE	DESCRIPTION	SAFE WORKING LOAD
CH140335	1/4	3150
CH140345	5/16	4700
CH140355	3/8	6600
CH140361	7/16	8800
CH140371	1/2	11300

CROCHETS
GRAPPIN À ŒIL



EYE TYPE
GRAB HOOKS

GRADE 30

ACIER AU CARBONE COULEUR GRIS / CARBON STEEL COLOUR GREY

NOTRE CODE	DESCRIPTION	CHARGE AMD. (lbs)
OUR CODE	DESCRIPTION	SAFE WORKING LOAD
*****	1/4	2600
*****	5/16	3900
*****	3/8	5400

CROCHETS FORGÉS POUR CHAÎNE / FORGED CHAIN HOOKS

CROCHETS COULISSANTS
À MANILLE



CLEVIS SLIP
HOOKS

GRADE 30

ACIER AU CARBONE COULEUR GRIS / CARBON STEEL COLOUR GREY

NOTRE CODE	DESCRIPTION	CHARGE AMD. (lbs)
OUR CODE	DESCRIPTION	SAFE WORKING LOAD
CH140390	1/4	1950
CH140400	5/16	2875
CH140410	3/8	4000
CH140407	7/16	5000
CH140411	1/2	6500

GRADE 70

ACIER D'ALLIAGE DE CHROMATE JAUNE / CHROMATE YELLOW STEEL PLATED

NOTRE CODE	DESCRIPTION	CHARGE AMD. (lbs)
OUR CODE	DESCRIPTION	SAFE WORKING LOAD
CH140392	1/4	2750
CH140401	5/16	4300
CH140408	3/8	5250
CH140413	7/16	7000
*****	1/2	9000

CROCHETS COULISSANTS
À ŒIL



EYE TYPE
SLIP HOOKS

GRADE 30

ACIER AU CARBONE COULEUR GRIS / CARBON STEEL COLOUR GREY

NOTRE CODE	DESCRIPTION	CHARGE AMD. (lbs)
OUR CODE	DESCRIPTION	SAFE WORKING LOAD
*****	1/4	1950
*****	5/16	2875
CH140409	3/8	4000



Tel.: (819) 346-2903 / (888) 345-2903 Fax.: (819) 346-3389
Email: distributeur@boulonstrie.com

**CROCHETS À ŒIL AVEC
LINGUET DE SÉCURITÉ
POUR CABLE**



**EYE HOOKS WITH
SECURITY LATCH
FOR CABLE**

ACIER AU CARBONE / CARBON STEEL

NOTRE CODE	CHARGE ADM.	OUVERTURE (LINGUET)	DIAMÈTRE ŒILLET
OUR CODE	ADM. CHARGE	OPENING (LATCH)	EYE DIAMETER
CH140414	3/4 T	7/8	3/4
CH140415	1 T	1	7/8
CH140416	1 1/2 T	1 1/16	1 1/8
*****	2 T	1 1/4	1 3/16
*****	3 T	1 1/2	1 9/16
*****	5 T	1 7/8	2
*****	7 1/2 T	2 1/4	-

LINGUETS

LATCHES

ACIER INOXYDABLE / STAINLESS STEEL

NOTRE CODE	CHARGE ADM.
OUR CODE	ADM. CHARGE
CH140417	3/4 - 1 T

AVEC LINGUET / WITH LATCH

NOTRE CODE	DESCRIPTION	CHARGE ADM. (lbs)
OUR CODE	DESCRIPTION	SAFE WORKING LOAD
*****	1/4	3150
*****	5/16	4700
CH140404	3/8	6600
*****	1/2	11300

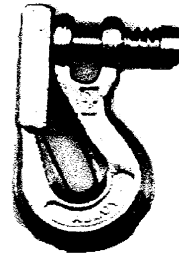

ACCESSOIRES POUR CHAÎNE DE LEVAGE
GRADE 80



NOTRE CODE	DESCRIPTION	CHARGE ADM. (lbs)
OUR CODE	DESCRIPTION	SAFE WORKING LOAD
*****	9/32	3500
CH140356	3/8	7100
*****	1/2	12000
*****	5/8	18100
*****	3/4	28300



AVEC LINGUET DE SÉCURITÉ / WITH SECURITY LATCH

NOTRE CODE	DESCRIPTION	CHARGE ADM. (lbs)
OUR CODE	DESCRIPTION	SAFE WORKING LOAD
*****	9/32	3500
CH140405	3/8	7100
*****	1/2	12000
*****	5/8	18100
*****	3/4	28300



NOTRE CODE	CAPACITÉ	HAUTEUR LIBRE	ÉLÉVATION NORMALE
OUR CODE	CAPACITY	CLEARANCE HEIGHT	STANDARD LIFT
	TONNE / TON	PO / IN	PI / FT
*****	1/2 t.	12"	10'
QP0TR110	1	15"	10'
QP0TR115	1 1/2	16"	10'
*****	2	18"	10'
*****	3	21"	10'

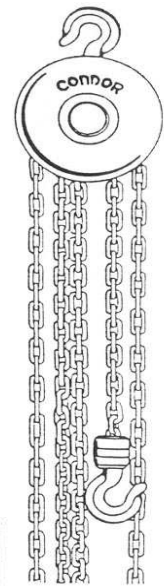

ENGRENAGE TRIPLE, FABRIQUÉ D'ACIER DE HAUTE QUALITÉ.
 CHAÎNE EN ALLIAGE D'ACIER TRAITÉ THERMIQUEMENT.
 MODÈLE LÉGER, UTILISATION FACILE ET SÉCURITAIRE.
 MEULÉ AVEC PRÉCISION, CROCHETS EN ACIER FORGÉ.

TRIPLE SPURED GEARS OF HIGH QUALITY STEEL,
 WITH PRECISION CUT TEETH.
 FORGED STEEL HOOKS HIGH ALLOY HEAT TREATED STEEL CHAIN.
 SAFETY IN OPERATION, LIGHT WEIGHT AND EASY HANDLING.

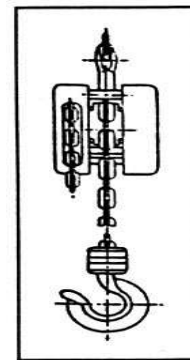

CHARIOTS

TROLLEY

NOTRE CODE	CAPACITÉ	POUR POUTRE EN " I "
OUR CODE	CAPACITY	FOR " I " BEAM
QP0PT410	1 t.	2" - 5"
QP0PT420	2	3" - 6"
*****	3	3" - 6"

COUSSINETS À ROULEAUX.
 CHARIOTS RÉGLABLE "SPEED".

ROLLER BEARINGS.
 "SPEED" ADJUSTABLE TROLLEY.

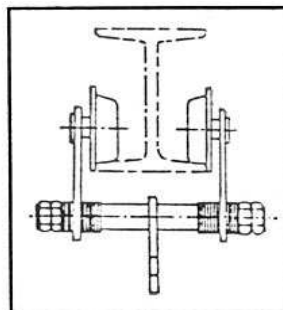
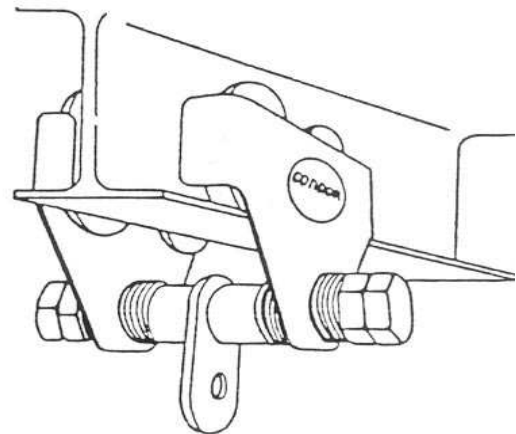

Tel.: (819) 346-2903 / (888) 345-2903 Fax.: (819) 346-3389

Email: distributeur@boulonsestrie.com



"Golden pin"

NOTRE CODE	DESCRIPTION	CHARGE ADM. (TONNES)
OUR CODE	DESCRIPTION	ADM.CHARGE(TONS)
CH140470	3/16	1/3
CH140471	1/4	1/2
CH140472	5/16	3/4
CH140473	3/8	1
CH140474	7/16	1 1/2
CH140475	1/2	2
CH140476	5/8	3 1/4
CH140477	3/4	4 3/4
CH140478	7/8	6 1/2
CH140479	1	8 1/2
*****	1 1/8	9 1/2
*****	1 1/4	12
CH140481	1 3/8	13 1/2
*****	1 1/2	17
*****	1 3/4	25
*****	2	35
*****	2 1/2	55

*** NE JAMAIS DÉPASSER LA CHARGE ADM. ÉCRITE PLUS HAUT***
DON'T OVERLOADED (VERIFY AMD.CHARGE)

AUSSI DISPONIBLE / ALSO AVAILABLE

MANILLES D'ANCRAGE EN ACIER INOXYDABLE SS316
CLEVIS SCREWS IN STAINLESS STEEL SS316



Tel.: (819) 346-2903 / (888) 345-2903 Fax.: (819) 346-3389

Email: distributeur@boulonstrie.com



FINI GALVANISÉ / GALVANIZED FINISH

NOTRE CODE	DESCRIPTION	CHARGE ADM.(TONNES)
OUR CODE	DESCRIPTION	ADM. CHARGE (TONS)
CH140459	3/16	1/3
CH140460	1/4	1/2
CH140461	5/16	3/4
CH140462	3/8	1
CH140463	7/16	1 1/2
CH140464	1/2	2
CH140465	5/8	3 1/4
CH140466	3/4	4 3/4
CH140467	1	8 1/2
CH140468	1 1/8	9 1/2

****NE JAMAIS DÉPASSER LA CHARGE ADM. ÉCRITE PLUS HAUT****
****DON'T OVERLOADED (VERIFY AMD. CHARGE)****

***** SANS CLASSIFICATION DE CHARGE *****

ZINC/PLATED

NOTRE CODE	DESCRIPTION	CHARGE ADM.
OUR CODE	DESCRIPTION	ADM. CHARGE
CH140450	1/4	<p>SANS CLASSIFICATION *****</p>
CH140451	5/16	
CH140452	3/8	
CH140453	7/16	
CH140454	1/2	
CH140455	5/8	
CH140456	3/4	
CH140457	7/8	

****CES MANILLES D'ANCRAGE NE SONT PAS CONÇUES POUR DES APPLICATIONS DE LEVAGE****

****THOSE CLEVIS SCREWS ARE NOT CONCEIVE TO LIFT****



Tel.: (819) 346-2903 / (888) 345-2903 Fax.: (819) 346-3389

Email: distributeur@boulonsestrie.com

MAILLONS À RIVET

RIVET LINKS

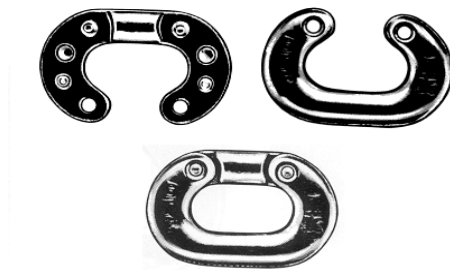

NOTRE CODE	DESCRIPTION	LONGUEUR INTERNE	LARGEUR INTERNE
OUR CODE	DESCRIPTION	INDIDE LENGTH	INSIDE WIDTH
CH140979	3/16	11/16	11/32
CH140980	1/4	7/8	7/16
CH140981	5/16	15/16	15/32
CH140982	3/8	1 1/8	9/16
CH140983	1/2	1 15/32	21/32
*****	5/8	1 13/16	25/32
*****	3/4	2 1/8	15/16
*****	7/8	2 1/2	1 1/8

MAILLONS RAPIDES

QUICK LINKS

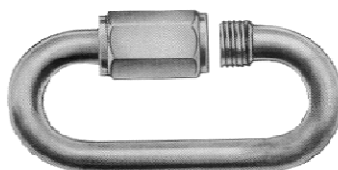

NOTRE CODE	DESCRIPTION	LONGUEUR INTERNE	LARGEUR INTERNE
OUR CODE	DESCRIPTION	INDIDE LENGTH	INSIDE WIDTH
CH140600	1/8	31 mm	11 mm
*****	5/32	34 mm	12 mm
CH140610	3/16	39 mm	13 mm
CH140620	1/4	45 mm	14 mm
CH140630	5/16	58 mm	17 mm
CH140640	3/8	70 mm	21 mm
CH140650	7/16	78 mm	22 mm
CH140660	1/2	80 mm	24 mm



Tel.: (819) 346-2903 / (888) 345-2903 Fax.: (819) 346-3389

Email: distributeur@boulonstrie.com

GOUPILLES À ANNEAU

LINCH PINS

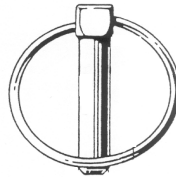

NOTRE CODE	DIAMÈTRE GOUPILLE	LONGUEUR GOUPILLE
OUR CODE	PIN DIAMETER	PIN LENGTH
CH187187	3/16	1 9/16
CH187188	1/4	1 3/4
CH187189	5/16	1 3/4
CH187191	3/8	1 3/4
CH187192	7/16	1 3/4

GOUPILLES D'ATTACHE

HITCH PINS

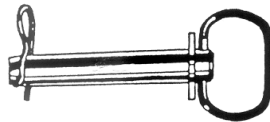

NOTRE CODE	DIAMÈTRE GOUPILLE	LONGUEUR GOUPILLE
OUR CODE	PIN DIAMETER	PIN LENGTH
CH187208	5/8	3 3/4
CH187209	5/8	6
CH187210	3/4	6 1/4
CH187212	7/8	6 1/2
CH187249	1	4 3/4
CH187250	1	6 3/4

ANNEAUX À CLÉ

KEY RINGS

NOTRE CODE	DIAMÈTRE EXTÉRIEUR
OUR CODE	OUTSIDE DIAMETER
KR000625	5/8
KR000750	3/4
KR001000	1
KR001500	1 1/2
KR002000	2

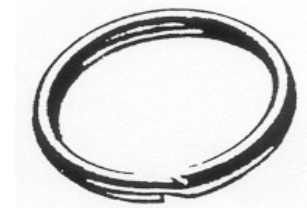

SUR DEMANDE / ON REQUEST



MAILLONS FROIDS
STEEL COLD SHUT

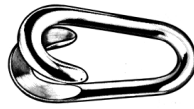

MAILLONS FENDUS
SPLIT REPAIR LINKS



MAILLONS JUMEAUX
MID LINKS



*****VOIR PAGE Q-13*****

SANGLES EN CAOUTCHOUC AVEC CROCHETS
RUBBER TARP STRAPS WITH HOOKS

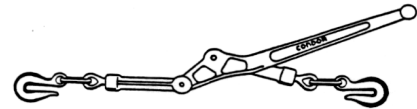

*****VOIR PAGE I-8*****

ATTACHES DE CHARGE
LOAD BINDERS



ÉLINGUES DE CHAÎNE
CHAIN SLINGS

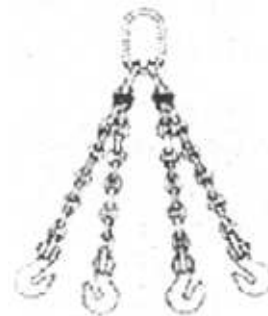

SIMPLE ,DOUBLE,TRIPLE ET QUADRUPLE



ÉMÉRILLONS EN FONTE MALLÉABLE PLAQUÉ ZINC
MALLEABLE IRON CHAIN SWIVEL ZINC PLATED



Tel.: (819) 346-2903 / (888) 345-2903 Fax.: (819) 346-3389
Email: distributeur@boulonsestrie.com

**ŒIL/ŒIL
EYE/EYE**

TENDEURS

TURNBUCKLES



NOTRE CODE	#REF	DIA. FILETAGE	LONGUEUR FERMÉE	LONGUEUR OUVERTE	DIA. INT. ŒILLET	LONGUEUR DU CORPS
OUR CODE	#REF	THRED DIA.	CLOSED LENGTH	OPENED LENGTH	EYE INSIDE DIA.	BODY LENGTH
*****	5011	5/32	3 1/2	4 3/4	7/32	1 3/4
TU187037	5012	3/16	3 7/8	5 1/2	1/4	2 3/4
TU121047	5013	7/32	4 1/2	6 3/8	5/16	2 3/4
TU125055	5014	1/4	5 1/2	7 5/8	11/32	3 1/8
TU131070	5015	5/16	6 3/4	9 3/8	3/8	3 3/4
TU137075	5016	3/8	7 1/2	10 1/2	1/2	4 1/8

**CROCHET/ŒIL
HOOK/EYE**

TENDEURS

TURNBUCKLES



NOTRE CODE	#REF	DIA. FILETAGE	LONGUEUR FERMÉE	LONGUEUR OUVERTE	DIA. INT. ŒILLET	LONGUEUR DU CORPS
OUR CODE	#REF	THREAD DIA.	CLOSED LENGTH	OPENED LENGTH	EYE INSIDE DIA.	BODY LENGTH
*****	5021	5/32	3 1/2	4 3/4	7/32	1 3/4
*****	5022	3/16	3 7/8	5 1/2	1/4	2 3/4
*****	5023	7/32	4 1/2	6 3/8	5/16	2 3/4
TU125030	5024	1/4	5 1/2	7 5/8	11/32	3 1/8
*****	5025	5/16	6 3/4	9 3/8	3/8	3 3/4
*****	5026	3/8	7 1/2	10 1/2	1/2	4 1/8

AUSSI DISPONIBLE SS-316 / ALSO AVAILABLE SS-316

PITONS AVEC ÉCROUS

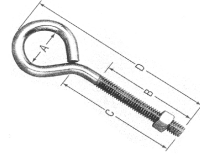

EYE BOLTS AND NUTS

NOTRE CODE	# REF	DIA. FILETAGE	LONGUEUR TOTALE	DIA. INT. ŒILLET	LONGUEUR FILATAGE	LONGUEUR TIGE
OUR CODE	# REF	THREAD DIA.	OVERALL LENGTH	EYE INSIDE DIA.	THREAD LENGTH	SHANK LENGTH
EB018020	5102	3/16	2	3/8	1 1/8	1 5/16
EB018025	5104	3/16	2 1/2	3/8	1 5/8	1 3/4
EB025020	5106	1/4	2	9/16	7/8	1
EB025025	5107	1/4	2 1/2	9/16	1 3/8	1 1/2
EB025030	5108	1/4	3	9/16	1 3/4	2
EB025040	5109	1/4	4	9/16	2 3/4	3
EB025050	5110	1/4	5	9/16	3	4
EB025060	5111	1/4	6	7/16	3	5
EB031032	5112	5/16	3 1/4	11/16	1 3/4	2
EB031040	5113	5/16	4	11/16	2 1/2	2 3/4
EB031050	5114	5/16	5	11/16	3	3 3/4
EB031060	5115	5/16	6	11/16	3	4 3/4
EB037040	5117	3/8	4	7/8	2 1/8	2 3/8
EB037050	5118	3/8	5	7/8	3 1/4	3 3/8
EB037060	5119	3/8	6	7/8	3 1/4	4 3/8
EB037080	5120	3/8	8	7/8	3 1/4	6 3/8
EB050060	5226	1/2	6	1 1/4	3	4
*****	5228	1/2	8	1 1/4	3	6
*****	5229	1/2	10	1 1/4	3	8
*****	5230	1/2	12	1 1/4	3	10

PITONS AVEC ÉCROUS AVEC ÉPAULEMENT
EYE BOLTS SHOULDER & NUTS



ÉCROUS À ŒIL
EYE NUTS



"A" SUITE, PETITS
ŒILLETS À VIS



SCREW EYES
"A" SUIT

NOTRE CODE	#REF	LONG. TOTALE	LONGUEUR TIGE	DIA. FIL	DIA. INT. ŒILLET
OUR CODE	#REF	OVERALL LENGTH	SHANK LENGTH	WIRE DIA.	EYE INSIDE DIA.
*****	5401	5/8	3/8	1/16	1/8
*****	5402	3/4	15/32	3/32	9/64
OV00093	5404	7/8	9/16	3/32	5/32
*****	5406	1 3/32	37/64	1/8	13/64
*****	5408	1 5/16	3/4	5/32	1/4
OV001562	5410	1 9/16	15/16	3/16	9/32
OV000500	5415	1/2	7/32	1/16	9/64
*****	5417	7/16	7/32	1/16	1/8

"B" SUITE, ŒILLETS
À VIS MÉDIUM



MEDIUM SCREW EYES
"B" SUIT

NOTRE CODE	#REF	LONG. TOTALE	LONGUEUR TIGE	DIA. FIL	DIA. INT. ŒILLET
OUR CODE	#REF	OVERALL LENGTH	SHANK LENGTH	WIRE DIA.	EYE INSIDE DIA.
OV000812	5501	13/16	1/2	.070	7/32
OV000875	5502	7/8	1/2	.083	15/64
OV001000	5504	1	9/16	.106	9/32
OV001125	5506	1 1/8	5/8	.128	5/16
OV001312	5508	1 5/16	3/4	.158	11/32
OV001561	5510	1 9/16	7/8	.182	3/8
OV001875	5512	1 7/8	1 1/8	.205	15/32
OV002125	5514	2 1/8	1 1/8	.232	1/2
OV002375	5516	2 3/8	1 3/8	.270	17/32
OV002625	5518	2 5/8	1 1/2	.292	9/16
OV002875	5520	2 7/8	1 5/8	.320	5/8





NOTRE CODE	#REF	DIA. FILETAGE	LONG. FILETAGE	LONG. TOTALE	LONG. TIGE	DIA. INT CILLET
OUR CODE	#REF	THREAD DIA.	THREAD LENGTH	OVERALL LENGTH	SHANK LENGTH	EYE INSIDE DIA.
PB250037	5151	1/4	1 9/16	3 3/4	2 3/4	9/16
PB250050	5152	1/4	1 9/16	5	4	9/16
PB315040	5153	5/16	1 9/16	4	2 3/4	3/4
PB315060	5154	5/16	1 9/16	6	4 3/4	3/4
PB375045	5155	3/8	1 3/4	4 1/2	3	7/8
PB375080	5156	3/8	1 3/4	8	6 1/4	7/8





NOTRE CODE	# REF	RÉSISTANCE (lb.)	QTÉ/BTE
OUR CODE	#REF	RESISTANCE (kg ou g)	QTY/BOX
*****	BL30685	1 lb./500 g	6
*****	BL30690	5 lb./2 kg	6
CC000010	BL30695	10 lb./4.5 kg	6
CC000020	BL30700	20 lb./9 kg	6
CC000030	BL30705	30 lb./14 kg	5
CC000040	BL30710	40 lb./18 kg	4
*****	BL30715	50 lb./23 kg	3
CC000100	BL30720	100 lb. /45 kg	2

CROCHETS EN "S"



"S" HOOKS

NOTRE CODE	#REF	DIA. FIL X LONG. TOTAL	QTÉ/BTE
OUR CODE	#REF	WIRE DIA. X OVERALL LENGTH	QTY/BOX
SH000100	5130	3/32 X 1	100
SH000140	5131	1/8 X 1 1/2	20
SH000176	5132	3/16 X 2	20
SH000212	5134	1/4 X 2 1/2	20
SH000307	5136	5/16 X 3	20

"M" SUIT



SCREW HOOKS

CROCHETS VIS

"M" SUIT

NOTRE CODE	#REF	DIA. FIL X LONG. TOTAL	QTÉ/BTE
OUR CODE	#REF	WIRE DIA. X OVERALL LENGTH	QTY/BOX
*****	5702	3/32 X 1 3/8	100
CV001625	5704	3/32 X 1 5/8	100
*****	5706	1/8 X 1 7/8	100
CV002250	5708	5/32 X 2 1/4	100
CV002750	5710	3/16 X 2 3/4	100
*****	5712	7/32 X 3 1/4	100
CV003750	5714	1/4 X 3 3/4	50
CV004250	5716	9/32 X 4 1/4	50
CV004500	5718	9/32 X 4 1/2	50
CV004501	5720	5/16 X 4 1/2	50



NOTRE CODE	#REF	DIA. FIL X LONGUEUR TOTALE	QTÉ/BTE
OUR CODE	#REF	WIRE DIA. X OVERALL LENGTH	QTY/BOX
CC512012	5732	1/8 X 1 1/4	100
CC512015	5735	1/8 X 1 1/2	100
CC515020	5737	5/32 X 2	100
CC518030	5740	3/16 X 3	100

CROCHETS À VIS
EN LAITON

BRASS SCREW
(SHOULDER) HOOKS



NOTRE CODE	#REF	GRANDEUR X DIA. FIL X LONGUEUR TOTALE	QTÉ/BTE
OUR CODE	#REF	SIZE X WIRE DIA. X OVERALL LENGTH	QTY/BOX
*****	5750	1/2 X 1/16 X 7/8	100
*****	5752	3/4 X 3/32 X 1 1/8	100
CC005754	5754	1" X 1/8 X 1 1/2	100

CROCHETS DE TASSE
EN LAITON

CUP HOOKS
BRASS



NOTRE CODE	#REF	GRANDEUR X DIA. FIL X LONGUEUR TOTALE	QTÉ/BTE
OUR CODE	#REF	SIZE X WIRE DIA. X OVERALL LENGTH	QTY/BOX
CT000500	5780	1/2 X 3/32 X 7/8	100
CT000625	5781	5/8 X 3/32 X 1	100
CT000750	5782	3/4 X 3/32 X 1 1/8	100
CT000875	5783	7/8 X 1/8 X 1 5/16	100
CT001000	5784	1 X 1/8 X 1 1/2	100
CT001250	5785	1 1/4 X 5/32 X 1 3/4	50
CT001500	5786	1 1/2 X 5/32 X 2 1/8	50

CROCHETS DE PORTE
À GÊILLES À VIS

GATE HOOKS
AND SCREW EYES



NOTRE CODE	#REF	DIA. FIL X LONGUEUR TOTALE	QTÉ/BTE
OUR CODE	#REF	WIRE DIA. X OVERALL LENGTH	QTY/BOX
*****	5815	1/8 X 1 1/2	100
CP000200	5820	5/32 X 2	100
*****	5825	5/32 X 2 1/2	100
CP000300	5830	3/16 X 3	100



NOTRE CODE	#REF	DIA. FIL X LONGUEUR TOTALE	QTÉ/BTE
OUR CODE	#REF	WIRE DIA. X OVERALL LENGTH	QTY/BOX
CP000400	5840	3/16 X 4	50
CP000600	5860	1/4 X 6	50
*****	5908	3/16 X 8	50
*****	5910	3/16 X 10	20
*****	5912	3/16 X 12	20

BOULONS À ANNEAU
AVEC ÉCROUS



RING BOLTS
AND NUTS

NOTRE CODE	#REF	LONGUEUR DE LA TIGE (RING DIA.)	QTÉ/BTE
OUR CODE	#REF	SHANK LENGHT(DIAMÈTRE ANNEAU)	QTY/BOX
*****	5172	2 1/2 (2 X 9/32)	10
*****	5173	6 (2 X 9/32)	10

ANNEAUX D'ACCROCHAGE À BOIS



HITCHING RINGS (LAG THREAD)

NOTRE CODE	#REF	DIAM. ANNEAU X (LONGUEUR TIGE)	QTÉ/BTE
OUR CODE	#REF	RING DIAMETER X (SHANK LENGTH)	QTY/BOX
Q0005177	5177	2" X 5/16 X (2 1/2")	10

ANNEAUX D'ACCROCHAGE



HITCHING RINGS (PLATE STYLE)

NOTRE CODE	#REF	DIAM. ANNEAU X (GRANDEUR PLAQUE)	QTÉ/BTE
OUR CODE	#REF	RING DIAMETER X (PLATE SIZE)	QTY/BOX
Q0005178	5178	2" X 5/16 X (2 X 2")	10



Tel.: (819) 346-2903 / (888) 345-2903 Fax.: (819) 346-3389

Email: distributeur@boulonsestrie.com

EXEMPLE: 7/8 X 3 3/4
 7/8 EST LE DIAMÈTRE
 DE L'OEIL ET 3 3/4 EST
 LA LONGUEUR DU MOUSQUETON

EXEMPLE: 7/8 X 3 3/4
 7/8 IS THE EYE DIAMETER
 AND 3 3/4 IS THE LENGTH SNAIL

MOUSQUETON
 SIMPLEX ŒIL PIVOT



SIMPLEX WIRE SNAP
 SWIVEL EYE

N° DE RÉFÉRENCE	DIAMÈTRE ŒIL X LONGUEUR	QTÉ/EMB
REFERENCE N°	EYE DIAMETER X LENGTH	QTY/PACK
734A	1/2 X 1 1/2	10

MOUSQUETON
 ŒIL FIXE



BABY SNAP
 FIX EYE

N° DE RÉFÉRENCE	DIAMÈTRE ŒIL X LONGUEUR	QTÉ/EMB
REFERENCE N°	EYE DIAMETER X LENGTH	QTY/PACK
150	3/8 X 1 3/4	10

MOUSQUETON
 ŒIL ROND



CHAMPION SNAP
 ROUND EYE

N° DE RÉFÉRENCE	DIAMÈTRE ŒIL X LONGUEUR	QTÉ/EMB
REFERENCE N°	EYE DIAMETER X LENGTH	QTY/PACK
108-19	3/4 X 3 3/8	10

MOUSQUETON
 ŒIL PIVOT OUVERT



CHAMPION SNAP
 OPEN SWIVEL EYE

N° DE RÉFÉRENCE	DIAMÈTRE ŒIL X LONGUEUR	QTÉ/EMB
REFERENCE N°	EYE DIAMETER X LENGTH	QTY/PACK
1087	3/8 X 2 1/2	10

MOUSQUETON
 ŒIL ROND PIVOT



CHAMPION SNAP
 SWIVEL ROUND EYE

N° DE RÉFÉRENCE	DIAMÈTRE ŒIL X LONGUEUR	QTÉ/EMB
REFERENCE N°	EYE DIAMETER X LENGTH	QTY/PACK
1088	3/8 X 2 1/2	10



Tel.: (819) 346-2903 / (888) 345-2903 Fax.: (819) 346-3389
 Email: distributeur@boulonsestrie.com

EXEMPLE: 7/8 X 3 3/4
 7/8 EST LE DIAMÈTRE
 DE L'OEIL ET 3 3/4 EST
 LA LONGUEUR DU MOUSQUETON

EXEMPLE: 7/8 X 3 3/4
 7/8 IS THE EYE DIAMETER
 AND 3 3/4 IS THE LENGTH SNAIL

MOUSQUETON
 ŒIL CARRÉ À ROULEAU



EYE SNAP, SQUARE
 EYE WITH ROLLER

N° DE RÉFÉRENCE	DIAMÈTRE ŒIL X LONGUEUR	QTÉ/EMB
REFERENCE N°	EYE DIAMETER X LENGTH	QTY/PACK
1089	5/8 X 2 1/4	10

MOUSQUETONS À BOULON
 ŒIL PIVOT



BOLT SNAPS
 SWIVEL EYE

N° DE RÉFÉRENCE	DIAMÈTRE ŒIL X LONGUEUR	QTÉ/EMB
REFERENCE N°	EYE DIAMETER X LENGTH	QTY/PACK
50-10	3/8 X 3	10
CH145013	1/2 X 3	10
50-16	5/8 X 3 1/4	10
CH145019	3/4 X 3 3/8	10
CH145020	1 X 3 7/8	10
CH145021	1 1/8 X 4 1/4	10

MOUSQUETON À BOULON
 ŒIL OUVERT



BOLT SNAP
 OPEN EYE

N° DE RÉFÉRENCE	DIAMÈTRE ŒIL X LONGUEUR	QTÉ/EMB
REFERENCE N°	EYE DIAMETER X LENGTH	QTY/PACK
70	5/8 X 4	10

MOUSQUETONS À BOULONS
 ŒIL CARRÉ PIVOT



BOLT SNAPS
 SQUARE SWIVEL EYE

N° DE RÉFÉRENCE	DIAMÈTRE ŒIL X LONGUEUR	QTÉ/EMB
REFERENCE N°	EYE DIAMETER X LENGTH	QTY/PACK
CH145219	3/4 X 3	10
CH145014	1 X 3	10



Tel.: (819) 346-2903 / (888) 345-2903 Fax.: (819) 346-3389
 Email: distributeur@boulonsestrie.com

EXEMPLE: 7/8 X 3 3/4
 7/8 EST LE DIAMÈTRE
 DE L'OEIL ET 3 3/4 EST
 LA LONGUEUR DU MOUSQUETON

EXEMPLE: 7/8 X 3 3/4
 7/8 IS THE EYE DIAMETER
 AND 3 3/4 IS THE LENGTH SNAP

MOUSQUETONS À
 BOULON DOUBLE

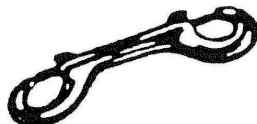

DOUBLE BOLT SNAPS

N° DE RÉFÉRENCE	DIAMÈTRE ŒIL X LONGUEUR	QTÉ/EMB
REFERENCE N°	EYE DIAMETER X LENGTH	QTY/PACK
72-35	1/2 X 3 1/2	10
CH140724	1/2 X 4	10
72-45	1/2 X 4 1/2	10

MOUSQUETONS
 ŒIL CARRÉ FIXE
 ACIER MALLÉABLE



CHAMPION SNAPS
 SQUARE FIXED EYE
 MALLEABLE CAST STEEL

N° DE RÉFÉRENCE	DIAMÈTRE ŒIL X LONGUEUR	QTÉ/EMB
REFERENCE N°	EYE DIAMETER X LENGTH	QTY/PACK
135-19	3/4 X 2 5/8	10
135-25	1 X 3 1/8	10
135-29	1 1/8 X 3 1/8	10
135-38	1 1/2 X 3 1/8	5
135-51	2 X 3 1/2	5

MOUSQUETONS
 ŒIL PIVOT
 RESSORT INOXYDABLE

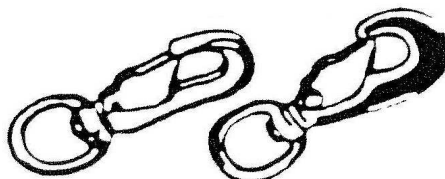

LEVER SNAPS
 SWIVEL EYE
 STAINLESS SPRINGS

N° DE RÉFÉRENCE	DIAMÈTRE ŒIL X LONGUEUR	QTÉ/EMB
REFERENCE N°	EYE DIAMETER X LENGTH	QTY/PACK
188-16	5/8 X 3 1/8	10
188-19	3/4 X 3 1/4	10
188-25	1 X 1 1/2	10
CH141829	1 1/8 X 4 3/4	10



Tel.: (819) 346-2903 / (888) 345-2903 Fax.: (819) 346-3389
 Email: distributeur@boulonsestrie.com

EXEMPLE: 7/8 X 3 3/4
 7/8 EST LE DIAMÈTRE
 DE L'OEIL ET 3 3/4 EST
 LA LONGUEUR DU MOUSQUETON

EXEMPLE: 7/8 X 3 3/4
 7/8 IS THE EYE DIAMETER
 AND 3 3/4 IS THE LENGTH SNAI

MOUSQUETON ŒIL DOUBLE



SNAP DOUBLE BREAST

N° DE RÉFÉRENCE	DIAMÈTRE ŒIL X LONGUEUR	QTÉ/EMB
REFERENCE N°	EYE DIAMETER X LENGTH	QTY/PACK
187	5	5

MOUSQUETOS TYPE
 CISEAU, ŒIL PIVOT

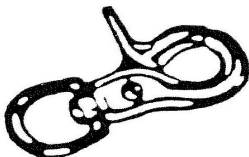

SCISSOR SNAP
 SWIVEL EYE

N° DE RÉFÉRENCE	DIAMÈTRE ŒIL X LONGUEUR	QTÉ/EMB
REFERENCE N°	EYE DIAMETER X LENGTH	QTY/PACK
CH140875	5/8 X 3	10

MOUSQUETONS
 SÉCURITAIRE, ŒIL PIVOT



SECURITY SNAP HOOKS
 SWIVEL EYE

N° DE RÉFÉRENCE	DIAMÈTRE ŒIL X LONGUEUR	QTÉ/EMB
REFERENCE N°	EYE DIAMETER X LENGTH	QTY/PACK
3142	7/8 X 3 3/4	10
3145	1 X 5	5

MOUSQUETON
 ANTI-PANIQUE, ŒIL FIXE



PANIC SNAP
 FIXED EYE

N° DE RÉFÉRENCE	DIAMÈTRE ŒIL X LONGUEUR	QTÉ/EMB
REFERENCE N°	EYE DIAMETER X LENGTH	QTY/PACK
1001	1/2 X 4	5



Tel.: (819) 346-2903 / (888) 345-2903 Fax.: (819) 346-3389
 Email: distributeur@boulonsestrie.com

EXEMPLE: 7/8 X 3 3/4
 7/8 EST LE DIAMÈTRE
 DE L'OEIL ET 3 3/4 EST
 LA LONGUEUR DU MOUSQUETON

EXEMPLE: 7/8 X 3 3/4
 7/8 IS THE EYE DIAMETER
 AND 3 3/4 IS THE LENGTH SNAIL

MOUSQUETON
 ANTI-PANIQUE
 ŒIL PIVOT

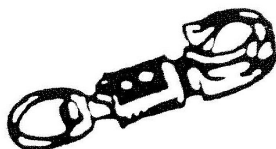

PANIC SNAP
 SWIVEL EYE

N° DE RÉFÉRENCE	DIAMÈTRE ŒIL X LONGUEUR	QTÉ/EMB
REFERENCE N°	EYE DIAMETER X LENGTH	QTY/PACK
1002	7/8 X 4 3/4	5

MOUSQUETON
 D'AMARRAGE



MOORING
 SNAP

N° DE RÉFÉRENCE	DIAMÈTRE ŒIL X LONGUEUR	QTÉ/EMB
REFERENCE N°	EYE DIAMETER X LENGTH	QTY/PACK
2311	3/4 X 3 1/2	5

MOUSQUETONS DE
 SÉCURITÉ



SECURITY WIRE
 SNAP HOOKS

PLAQUÉ ZINC

ZINC PLATED

N° DE RÉFÉRENCE	DIAMÈTRE ŒIL X LONGUEUR	QTÉ/EMB
REFERENCE N°	EYE DIAMETER X LENGTH	QTY/PACK
CH140187	3/16 X 2	10
CH140250	1/4 X 2 1/4	10
CH140315	5/16 X 3 1/8	10
CH140316	3/8 X 4	10
2355/120	7/16 X 4 3/4	10
2355/140	15/32 X 5 1/2	10



Tel.: (819) 346-2903 / (888) 345-2903 Fax.: (819) 346-3389
 Email: distributeur@boulonstrie.com

EXEMPLE: 7/8 X 3 3/4
 7/8 EST LE DIAMÈTRE
 DE L'OEIL ET 3 3/4 EST
 LA LONGUEUR DU MOUSQUETON

EXEMPLE: 7/8 X 3 3/4
 7/8 IS THE EYE DIAMETER
 AND 3 3/4 IS THE LENGTH SNAP

MOUSQUETONS EN LAITON POUR BATEAU / POLISH BRASS BOAT SNAP

MOUSQUETONS À BOULON
 ŒIL PIVOT



BOLT SNAPS
 SWIVEL EYE

N° DE RÉFÉRENCE	DIAMÈTRE ŒIL X LONGUEUR	QTÉ/EMB
REFERENCE N°	EYE DIAMETER X LENGTH	QTY/PACK
CH142359	1/2 X 3 1/8	10
CH142360	3/4 X 3 1/4	10
2359-25	1 X 3 1/2	10

MOUSQUETONS POUR
 BATEAU À ŒIL FIXE



BOAT SNAPS
 FIXED EYE

N° DE RÉFÉRENCE	DIAMÈTRE ŒIL X LONGUEUR	QTÉ/EMB
REFERENCE N°	EYE DIAMETER X LENGTH	QTY/PACK
2363 * 0	7/16 X 2 1/8	10
2363 * 1	5/8 X 2 7/8	10
CH142363	3/4 X 3 1/4	10
2363 * 3	3/4 X 3 7/8	10

MOUSQUETONS POUR BATEAU
 ŒIL PIVOT



BOAT SNAPS
 SWIVEL EYE

N° DE RÉFÉRENCE	DIAMÈTRE ŒIL X LONGUEUR	QTÉ/EMB
REFERENCE N°	EYE DIAMETER X LENGTH	QTY/PACK
2364 * 1	5/8 X 3 1/4	10
2364 * 2	3/4 X 3 3/4	10
CH142364	3/4 X 4 1/4	10



Tel.: (819) 346-2903 / (888) 345-2903 Fax.: (819) 346-3389
 Email: distributeur@boulonstrie.com

EXEMPLE: 7/8 X 3 3/4
 7/8 EST LE DIAMÈTRE
 DE L'OEIL ET 3 3/4 EST
 LA LONGUEUR DU MOUSQUETON

EXEMPLE: 7/8 X 3 3/4
 7/8 IS THE EYE DIAMETER
 AND 3 3/4 IS THE LENGTH SNAP

MOUSQUETON À BOULON
 DOUBLE, EN LAITON



BRASS BOLT SNAP
 DOUBLE EYE

N° DE RÉFÉRENCE	DIAMÈTRE ŒIL X LONGUEUR	QTÉ/EMB
REFERENCE N°	EYE DIAMETER X LENGTH	QTY/PACK
CH140163	1/2 X 4 1/2	10

MOUSQUETON EN LAITON
 ŒIL OUVERT



BRASS BOLT SNAP
 OPEN EYE

N° DE RÉFÉRENCE	DIAMÈTRE ŒIL X LONGUEUR	QTÉ/EMB
REFERENCE N°	EYE DIAMETER X LENGTH	QTY/PACK
CH140164	1/2 X 4	10

MOUSQUETON DE
 SECURITÉ, BRONZE



SECURITY SNAP
 HOOK, BRONZE

N° DE RÉFÉRENCE	DIAMÈTRE ŒIL X LONGUEUR	QTÉ/EMB
REFERENCE N°	EYE DIAMETER X LENGTH	QTY/PACK
CH143002	1 X 4 1/2	5

ANNEAUX SOUDÉS EN ACIER
 PLAQUÉ NICKEL



NICKEL PLATED WELDED
 STEEL RINGS (HARNES)

N° DE RÉFÉRENCE	DIAMÈTRE ŒIL X LONGUEUR	QTÉ/EMB
REFERENCE N°	EYE DIAMETER X LENGTH	QTY/PACK
1336* 1	3/16 X 1	20
CH931010	3/16 X 1 1/4	20
CH931012	1/4 X 1 1/2	20

ANNEAUX SOUDÉS
 EN ACIER AU CARBONE,
 GALVANISÉS À CHAUD

















HOT DIP GALVANIZED WELDED
 CARBON STEEL RINGS

N° DE RÉFÉRENCE	DIAMÈTRE ŒIL X LONGUEUR	QTÉ/EMB
REFERENCE N°	EYE DIAMETER X LENGTH	QTY/PACK
CH931013	1/4 X 2	20
CH931025	5/16 X 2 1/2	10
1347-3	3/8 X 3	10

SECTION J











MÈCHES / DRILLS

INFORMATION TECHNIQUE.....DÉBUT DE LA SECTION
 TECHNICAL INFORMATION.....BEGINNING OF THIS SECTION

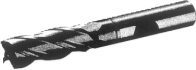
	DESCRIPTION	SECTION-PAGE
	MÈCHES EN ACIER RAPIDE. HIGH SPEED STEEL DRILL BITS.	J-1
	MÈCHES EN ACIER RAPIDE TIGE RÉDUITE. HIGH SPEED STEEL DRILLS REDUCED SHANK.	J-16
	MÈCHES MESURE EN LETTRE. LETTER SIZE DRILL BITS.	J-4
	MÈCHES EN ACIER RAPIDE MESURE EN NUMÉRO. NUMBER SIZE HIGH SPEED STEEL DRILL BITS.	J-5
	MÈCHES À BOIS. SPADE BITS.	J-16
	MÈCHES À EMBOUT RÉDUIT. REDUCED SHANK DRILLS.	J-2
	MÈCHES AU COBALT. COBALT DRILL BITS.	J-11
	MÈCHES EN ACIER RAPIDE AU TITANIUM. TITANIUM COATED DRILL BITS.	J-12
	MÈCHES EN ACIER RAPIDE, MÉTRIQUE. HIGH SPEED STEEL DRILL BITS, METRIC.	J-8
	MÈCHES EN ACIER RAPIDE STUB. SCREW MACHINE DRILLS.	J-3
	MÈCHES À CIMENT, BOUT CARBURE. MASONRY DRILLS, CARBIDE TIPPED.	J-13
	MÈCHES À CIMENT, TAPCON. MASONRY DRILL BITS, TAPCON.	J-13
	MÈCHES À CIMENT SDS-SHANK PLUS . MASONRY DRILL BITS SDS PLUS SHANK.	J-14
	ENS. DE MÈCHES TITANIUM, 1/16 À 1/2 (29 PCES). DRILL SET TITANIUM, 1/16 À 1/2 (29 PCES).	J-18
	ENS. DE MÈCHES SUPERBA, 9/16 À 1 (8 PCES). DRILL SET SUPERBA, 9/16 À 1 (8 PCES).	J-17
	ENS. DE MÈCHES ACIER RAPIDE, 1/16 À 1/2 (29 PCES). DRILL SET HIGH SPEED STEEL, 1/16 À 1/2 (29 PCES).	J-18

SECTION J

MÈCHES / DRILLS

DESCRIPTION	SECTION-PAGE
 <p>ENS. DE MÈCHES À ACIER RAPIDE 1/16 À 3/8 (21 PCES). DRILL SET HIGH SPEED STEEL 1/16 À 3/8 (21 PCES).</p>	J-17
 <p>ENS. DE MÈCHES ET D'EXTRACTEURS. DRILL AND EXTRACTOR SET.</p>	J-17
<p>COFFRE POUR 29 MÈCHES. BOX FOR 29 DRILLS.</p>	J-17
 <p>EXTRACTEURS DE VIS DROIT. STRAIGHT SCREW EXTRACTORS.</p>	J-19
 <p>EXTRACTEURS DE VIS SPIRAL. SPIRAL SCREW EXTRACTORS.</p>	J-19
 <p>FRAISES DEUX LÈVRES. END MILLS TWO FLUTE.</p>	J-20
 <p>FRAISES LÈVRE MULTIPLES. END MILLS MULTI-FLUTE.</p>	SUR DEMANDE ON REQUEST
 <p>FRAISES QUATRE LÈVRES. END MILLS FOUR FLUTE.</p>	SUR DEMANDE ON REQUEST
 <p>FRAISE SIX LÈVRES. END MILLS SIX FLUTE.</p>	SUR DEMANDE ON REQUEST
 <p>MÈCHES À CENTRER. COMBINED DRILL AND COUNTERSINK.</p>	J-21
 <p>MÈCHES À QUEUE CONIQUE. TAPER SHANK DRILL.</p>	SUR DEMANDE ON REQUEST
 <p>MÈCHES CONIQUES SIMPLE LÈVRE. SINGLE-FLUTE COUNTERSINKS.</p>	SUR DEMANDE ON REQUEST
 <p>MÈCHES CONIQUES TROIS & CINQ LÈVRES. THREE & FIVE FLUTE COUNTERSINKS.</p>	SUR DEMANDE ON REQUEST

APPLICATIONS /

FEATURES

PAGE J-1

HIGH SPEED STEEL

DRILL BIT

MÈCHE EN ACIER RAPIDE



APPLICATIONS:

- * POUR SERVICE INTENSE.
- * PERÇAGE DU BOIS-MÉTAL-PLASTIQUE.
- * IDÉAL POUR ACIER ET MÉTAL TREMPÉ.

CARACTÉRISTIQUES:

- * FINI NOIR HAUTE TEMPÉRATURE.
- * POINTE 135° RAPIDE À CENTRAGE AUTOMATIQUE ET COUPE RAPIDE.

APPLICATIONS :

- * DESIGNED FOR HEAVY DUTY APPLICATIONS.
- * DRILL IN WOODS, STEEL, AND PLASTICS.
- * IDEAL FOR CARBON AND ALLOY STEELS.

FEATURES:

- * HIGH-TEMPERATURE, BLACK OXYDE SURFACE.
- * TREATMENT FOR SUPERIOR WEAR RESISTANT
- * 135° SPLIT POINT STARTS CUTTING IMMEDIATELY.
- * NO CENTER PUNCH NEEDED.

MÈCHE À EMBOUT RÉDUIT

REDUCED SHANK DRILL

PAGE J-2



APPLICATIONS :

- * POINTE À 118° PERMET LE CENTRAGE ET UN MINIMUM D'EFFORT POUR PERCER.
- * POUR PERCEUSE AVEC MANDRIN DE 1/2".
- * FINI BRILLANT.

APPLICATIONS :

- * 118° POINT CENTERS EASILY AND REQUIRES A MINIMUM OF FEED PRESSURE.
- * FITS ALL 1/2" DRILLS AND DRILLS PRESSES.
- * BRIGHT FINISH.

MÈCHE EN ACIER RAPIDE

HIGH SPEED STEEL

COURTE

PAGE J-3

STUB DRILL BIT

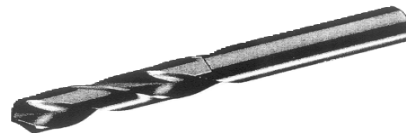

APPLICATIONS:

- * ACIER AU CARBON - ACIER TREMPÉ
- FONTE - LAITON.

CARACTÉRISTIQUES:

- * TIGE COURTE POUR PLUS DE SOLIDITÉ.
- * FINI BRILLANT, IDÉAL POUR LES MÉTAUX NON-FERREUX
- * POINTE À 118° QUI NE NÉCESSITE AUCUN POINÇONNAGE.

APPLICATIONS:

- * ALLOYED & CARBON STEEL,CAST IRON,BRASS.

FEATURES:

- *SHORT FLUTE LENGTH FOR ENHANCED RIGIDITY.
- * BRIGHT FINISH, EXCELLENT FOR NON-FERROUS APPLICATIONS & LOW TENSILE STEELS.
- * 118° POINT.

APPLICATIONS /**FEATURES****LETTER SIZE****MÈCHE MESURE****EN LETTRE****PAGE J-4****DRILL BIT**APPLICATIONS:

* PERÇAGE DE L'ACIER - BOIS - PLASTIQUE

* POINTE À 118° COUPE RAPIDE

APPLICATIONS:

* DRILLS IN STEEL, WOOD AND PLASTIC.

* 118° STARTS CUTTING IMMEDIATELY.

MÈCHE MESURE**EN NUMÉRO****PAGE J-5****NUMBER SIZE****DRILL BIT**APPLICATIONS:* POUR LE PERÇAGE DE TROUS DE
GRANDEURS PRÉCISES ENTRE LES
GROSSEURS FRACTIONNELLES.APPLICATIONS:* FOR USE WHERE PRECISION HOLE SIZING IS
REQUIRED IN SIZES UNDER 15/64.* WIRE GAUGE DIAMETER FALL IN
BETWEEN FRACTIONAL SIZES.* POPULAR TAPS THROUGH 1/4-28 REQUIRE
THE USE OF WIRE GAUGE DRILL BITS.CARACTÉRISTIQUES:

* POINTE À 118° USAGE GÉNÉRAL

FEATURES:

* 118° POINT FOR GENERAL PURPOSE DRILLING

MÈCHE MESURE**EN MÉTRIQUE****PAGE J-8****METRIC SIZE****DRILL BIT**APPLICATIONS:* POUR LE PERÇAGE DU MÉTAL TREMPÉ
ET DURCI - FONTE - ACIER CARBONEAPPLICATIONS:* ALLOYED STEEL, TOOL STEEL,
CAST IRON, CARBON STEEL.CARACTÉRISTIQUES:

* FINI NOIR

* RÉSISTANT À L'USURE

* POINTE À 118°

FEATURES:* GENERAL PURPOSE FLUTE CONSTRUCTION
FOR USE IN A WIDE VARIETY OF MATERIALS.* BLACK OXYDE FINISH INCREASES WEAR
RESISTANCE.* WHEN USED WITH COOLANT IT IMPROVES
LUBRICITY, REDUCING CHIP WELDING &
GALLING.

* 118° POINT FOR GENERAL PURPOSE DRILLING.

**APPLICATIONS /
FEATURES**

**MÈCHE AU
COBALT**

COBALT DRILL

PAGE J-10



APPLICATIONS:

- * IDÉAL POUR LE PERÇAGE DE L'ACIER INOXYDABLE

CARACTÉRISTIQUES:

- * POINTE À 135°

APPLICATIONS:

- * IDEAL FOR STAINLESS STEEL

FEATURES:

- * 135° POINT

**MÈCHE À FER
AU TITANIUM**

**TITANIUM COATED
DRILL BIT**

PAGE J-12



APPLICATIONS:

- * USINÉ AVEC PRÉCISION POUR L'ACIER - LE PLASTIQUE ET LE BOIS.
- * IDÉAL POUR L'ACIER TREMPÉ ET AU CARBONE.

CARACTÉRISTIQUES:

- * TITANIUM EST 6 FOIS PLUS PERFORMANT QUE LA MÈCHE ACIER RAPIDE.
- * POINTE À 135°.

APPLICATIONS:

- * PRECISION CRAFTED FOR DRILLING METALS, PLASTIC AND WOOD.
- * IDEAL FOR CARBON AND ALLOY STEEL.
- * NOT RECOMMENDED FOR DRILLING TITANIUM OR TITANIUM ALLOY.

FEATURES:

- * TITANIUM PROVIDES UP TO 6 TIMES THE LIFE OVER HIGH SPEED STEEL.
- * 135° SPLIT POINT STARTS CUTTING IMMEDIATELY.
- * NO CENTER PUNCH NEEDED.

**MÈCHE À CIMENT
BOUT AU CARBURE**

**CARBIDE TIP
MASONRY DRILL**

PAGE J-13



APPLICATIONS:

- * POUR LE PERÇAGE DE LA BRIQUE - CIMENT - TUILE.
- * POUR USAGE AVEC PERCEUSE ROTATIVE OU PERCUSSION.

APPLICATIONS:

- * SUITABLE FOR: BRICK - CEMENT - TILE - SLATE - CINDER BLOCK.
- * THE SPECIAL TUNGSTEN CARBIDE TIP CAN BE USED FOR ROTARY DRILLING OR FOR PERCUSSION.
- * TUNGSTEN CARBIDE
- * BLACK OXYDE
- * TEMPERED BODY FOR LONG LIFE



APPLICATIONS:

- * MÈCHE À CIMENT TIGE SDS
- * POUR LE PERÇAGE DU BÉTON -
BRIQUE - PIERRE.
- * POINTE AU CARBURE POUR
PERCEUSE À PERCUSSION.

APPLICATIONS:

- * FOR DRILLING IN CONCRETE, BRICK, STONE
AND OTHER MASONRY MATERIALS.
- * ANNEALED SHAFTS HELP PREVENT
BREAKAGE.
- * SHOT-PEENED FOR TORQUE TWIST
PROTECTION.
- * ALL BITS FALL WITHIN 90-100% ON
THE I.S.O. STANDARDS.

SDS-PLUS:

FITS ALL ROTARY HAMMERS WITH
SDS-PLUS AND HILTI
TE-C+ CHUCKS. ONLY USE DIAMETERS UP
TO 5/8" FOR HILTI TE 12. DIAMETERS EU
TO 3/4" MAY BE USED FOR HILTI TE 12 S.

- * SPECIAL FLUTING-DESIGNED TO
DRILL 15% FASTER THAN THE
AVERAGE FRILL.



CARACTÉRISTIQUES:

- * TRANCHANT À 15° POUR PERÇAGE PLUS
RAPIDE ET PLUS PROPRE.
- * PLEINE LONGUEUR TRAITÉE À CHAUD
POUR PLUS DE PUISSANCE

FEATURES:

- * UNIQUE 15° CHISEL EDGE DESIGN WITH
MORE ANGLE TO DIG INTO WOOD.
- * ISO-TEMP PROPRIETARY TOUGHENING
PROCESS PROVIDES GREATER DURABILITY.
- * ANGLED SPURS CUT A CLEANER, SMOOTHER
HOLE WITH LESS BINDING, BLASTING
THROUGHT WOOD KNOTS THAT STANDARD
BITS JUST CAN'T HANDLE!



Tel.: (819) 346-2903 / (888) 345-2903 Fax.: (819) 346-3389

Email: distributeur@boulonstrie.com

APPLICATIONS /

FEATURES

PAGE J-19

STRAIGHT

SCREW EXTRACTOR

**EXTRACTEUR DE VIS
DROIT**



APPLICATIONS:

- * PARFAIT POUR ENLEVER RAPIDEMENT ET FACILEMENT LES VIS- BOULONS- GOUJONS.

CARACTÉRISTIQUES:

- * ESTAMPÉ
- * MATÉRIEL HAUTE QUALITÉ ACIER RAPIDE
- * CALIBRE DE MÈCHE ET EXTRACTEUR APPROPRIÉ.

APPLICATIONS:

- * FOR QUICKLY AND EASILY REMOVING BROKEN SCREWS, PIPES,BOLTS AND STUDS.

FEATURES:

- * PERMANENTLY MARKED WITH PROPER DRILL TO USE.
- * SPECIAL TOOL STEEL, HEAT-TREATED AND HIGH TEMPERATURE SURFACE-TREATED TO RESIST RUST.
- * MANUFACTURED FROM HIGH QUALITY, HEAT-TREATED TOOL STEEL.
- * SIZES 1 THROUGHT 5 HAVE GROUND CENTER PUNCH POINTS.
- * SHARP, STRAIGHT TAPERED FLUTES BITE INTO WORK WITHOUT BINDING OR CHEWING.

**EXTRACTEUR DE VIS
SPIRAL**

PAGE J-19

**SPIRAL SCREW
EXTRACTOR**



APPLICATIONS:

- * PARFAIT POUR ENLEVER RAPIDEMENT ET FACILEMENT LES VIS- BOULONS- GOUJONS.

CARACTÉRISTIQUES:

- * ESTAMPÉ
- * MATÉRIEL HAUTE QUALITÉ ACIER RAPIDE
- * CALIBRE DE MÈCHE ET EXTRACTEUR APPROPRIÉ.

APPLICATIONS:

- * FOR QUICKLY AND EASILY REMOVING BROKEN SCREWS, PIPES,BOLTS AND STUDS.

FEATURES:

- * PERMANENTLY MARKED WITH PROPER DRILL TO USE.
- * SPIRAL FLUTE GRABS FIRMLY.
- * MANUFACTURED FROM HIGH QUALITY, HEAT-TREATED TOOL STEEL.
- * SIZES 1 THROUGHT 5 HAVE GROUND CENTER PUNCH POINTS.
- * HEAT TREATED AND TEMPERED TOOL STEEL FOR LONG LIFE.

**APPLICATIONS /
FEATURES**

MÈCHES

DRILLS

SPLIT POINT

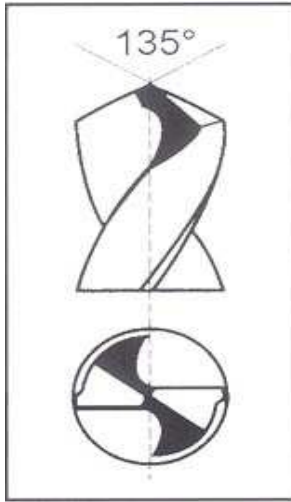

- * Un angle de coupe extra sur les deux pointes de coupe.
- * Pointe fendue est désignée ici en noir.
- * Le terme "pointe fendue " est de façon populaire réservé pour les mèches 135° acier rapide.

-
- * An extra cutting angle on the 2 cutting edges of a drill bit.
 - * Split Point is designated here in black.
 - * Split Pointing is almost always reserved for 135° HSS drill bits.

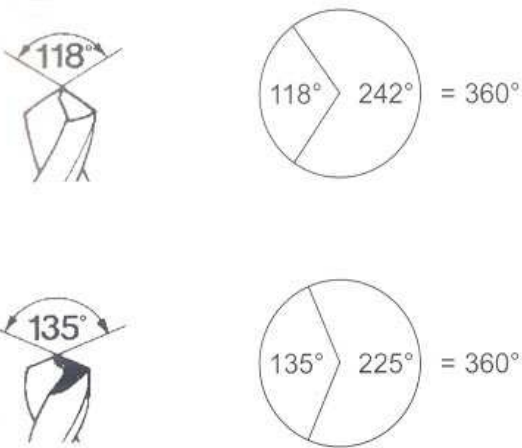

- * Les mèches 118° sont pour usage général.
- * Les mèches 118° ont tendance à glisser sur la surface si le matériel n'est pas poinçonné.

- * 118° drill bits have a sharp point and are common on standard / general purpose drill bits where light duty work is needed. Because of this sharp point, 118° drill bits will tend to " walk" or spin like a top on flat surfaces.
- This is why a centering drill or center punch is normally used to start off holes.
- If the operator has very steady hands, them the 118° drill bit can be used without center punching.

- * Les mèches 135° percent plus de trous.
- * Elles percent plus rapidement et ne glissent pas.

- * 135° drill bits have a flatter point which gives the drill bit more cutting surface area. When more surface area cuts the steel, drilling is faster.



TABLEAU ÉQUIVALENT / TECHNICAL DRILL

DECIMAL	FRACTION	METRIC
0.0059	#97	
0.0063	#96	
0.0067	#95	
0.0071	#94	
0.0075	#93	
0.0079	#92	.20
0.0083	#91	
0.0087	#90	.22
0.0091	#89	
0.0095	#88	
0.0098		.25
0.0100	#87	
0.0105	#86	
0.0110	#85	.28
0.0115	#84	
0.0118		.30
0.0120	#83	
0.0125	#82	
0.0126		.32
0.0130	#81	
0.0135	#80	
0.0138		.35
0.0145	#79	
0.0156	1/64	
0.0157		.40
0.0160	#78	
0.0177		.45
0.0180	#77	
0.0197		.50
0.0200	#76	
0.0210	#75	
0.0217		.55
0.0225	#74	
0.0236		.60
0.0240	#73	
0.0250	#72	
0.0256		.65
0.0260	#71	
0.0276		.70
0.0280	#70	
0.0292	#69	
0.0295		.75
0.0310	#68	
0.0312	1/32	
0.0315		.80

DECIMAL	FRACTION	METRIC
0.0320	#67	
0.0330	#66	
0.0335		.85
0.0350	#65	
0.0354		.90
0.0360	#64	
0.0370	#63	
0.0374		.95
0.0380	#62	
0.0390	#61	
0.0394		1.00
0.0400	#60	
0.0410	#59	
0.0413		1.05
0.0420	#58	
0.0430	#57	
0.0433		1.10
0.0453		1.15
0.0465	#56	
0.0469	3/64	
0.0472		1.20
0.0492		1.25
0.0512		1.30
0.0520	#55	
0.0531		1.35
0.0550	#54	
0.0551		1.40
0.0571		1.45
0.0591		1.50
0.0595	#53	
0.0610		1.55
0.0625	1/16	
0.0630		1.60
0.0635	#52	
0.0650		1.65
0.0669		1.70
0.0670	#51	
0.0689		1.75
0.0700	#50	
0.0709		1.80
0.0728		1.85
0.0700	#49	
0.0748		1.90
0.0760	#48	
0.0768		1.95

TABLEAU ÉQUIVALENT / TECHNICAL DRILL

DECIMAL	FRACTION	METRIC
0.0781	5/64	
0.0785	#47	
0.0787		2.00
0.0807		2.05
0.0810	#46	
0.0820	#45	
0.0827		2.10
0.0846		2.15
0.0860	#44	
0.0866		2.20
0.0886		2.25
0.0890	#43	
0.0906		2.30
0.0925		2.35
0.0935	#42	
0.0938	3/32	
0.0945		2.40
0.0960	#41	
0.0965		2.45
0.0980	#40	
0.0984		2.50
0.0995	#39	
0.1015	#38	
0.1024		2.60
0.1040	#37	
0.1063		2.70
0.1065	#36	
0.1083		2.75
0.1094	7/64	
0.1100	#35	
0.1102		2.80
0.1110	#34	
0.1130	#33	
0.1142		2.90
0.1160	#32	
0.1181		3.00
0.1200	#31	
0.1220		3.10
0.1250	1/8	
0.1260		3.20
0.1280		3.25
0.1285	#30	
0.1299		3.30
0.1339		3.40
0.1360	#29	

DECIMAL	FRACTION	METRIC
0.1378		3.50
0.1405	#28	
0.1406	9/64	
0.1417		3.60
0.1440	#27	
0.1457		3.70
0.1470	#26	
0.1476		3.75
0.1495	#25	
0.1496		3.80
0.1520	#24	
0.1535		3.90
0.1540	#23	
0.1562	5/32	
0.1570	#22	
0.1575		4.00
0.1590	#21	
0.1610	#20	
0.1614		4.10
0.1654		4.20
0.1660	#19	
0.1673		4.25
0.1693		4.30
0.1695	#18	
0.1719	11/64	
0.1730	#17	
0.1732		4.40
0.1770	#16	
0.1772		4.50
0.1800	#15	
0.1811		4.60
0.1820	#14	
0.1850	#13	
0.1870		4.75
0.1875	3/16	
0.1890	#12	
0.1910	#11	
0.1929		4.90
0.1935	#10	
0.1960	#9	
0.1969		5.00
0.1990	#8	
0.2008		5.10
0.2010	#7	
0.2031	13/64	

TABLEAU ÉQUIVALENT / TECHNICAL DRILL

DECIMAL	FRACTION	METRIC
0.2040	#6	
0.2047		5.20
0.2055	#5	
0.2067		5.25
0.2087		5.30
0.2090	#4	
0.2126		5.40
0.2130	#3	
0.2165		5.50
0.2188	7/32	
0.2205		5.60
0.2210	#2	
0.2244		5.70
0.2264		5.75
0.2280	#1	
0.2283		5.80
0.2323		5.90
0.2340	LTR A	
0.2344	15/64	
0.2362		6.00
0.2380	LTR B	
0.2402		6.10
0.2420	LTR C	
0.2441		6.20
0.2460	LTR D	
0.2461		6.25
0.2480		6.30
0.2500	1/4 , LTR E	
0.2520		6.40
0.2559		6.50
0.2570	LTR F	
0.2598		6.60
0.2610	LTR G	
0.2638		6.70
0.2656	17/64	
0.2657		6.75
0.2660	LTR H	
0.2677		6.80
0.2717		6.90
0.2720	LTR I	
0.2756		7.00
0.2770	LTR J	
0.2795		7.10
0.2810	LTR K	
0.2812	9/32	

DECIMAL	FRACTION	METRIC
0.2835		7.20
0.2854		7.25
0.2874		7.30
0.2900	LTR L	
0.2913		7.40
0.2950	LTR M	
0.2953		7.50
0.2969	19/64	
0.2992		7.60
0.3020	LTR N	
0.3031		7.70
0.3051		7.75
0.3071		7.80
0.3110		7.90
0.3125	5/16	
0.3150		8.00
0.3160	LTR O	
0.3189		8.10
0.3228		8.20
0.3230	LTR P	
0.3248		8.25
0.3268		8.30
0.3281	21/64	
0.3307		8.40
0.3320	LTR Q	
0.3346		8.50
0.3386		8.60
0.3390	LTR R	
0.3425		8.70
0.3438	11/32	
0.3445		8.75
0.3465		8.80
0.3480	LTR S	
0.3504		8.90
0.3543		9.00
0.3580	LTR T	
0.3583		9.10
0.3594	23/64	
0.3622		9.20
0.3642		9.25
0.3661		9.30
0.3680	LTR U	
0.3701		9.40
0.3740		9.50
0.3750	3/8	

TABLEAU ÉQUIVALENT / TECHNICAL DRILL

DECIMAL	FRACTION	METRIC
0.3770	LTR V	
0.3780		9.60
0.3819		9.70
0.3839		9.75
0.3858		9.80
0.3860	LTRW	
0.3898		9.90
0.3906	25/64	
0.3937		10.00
0.3970	LTR X	
0.4040	LTR Y	
0.4062	13/32	
0.4130	LTR Z	
0.4134		10.50
0.4219	27/64	
0.4331		11.00
0.4375	7/16	
0.4528		11.50
0.4531	29/64	
0.4688	15/32	
0.4724		12.00
0.4844	31/64	
0.4921		12.50
0.5000	1/2	
0.5118		13.00
0.5156	33/64	
0.5312	17/32	
0.5315		13.50
0.5469	35/64	
0.5512		14.00
0.5625	9/16	
0.5709		14.50
0.5781	37/64	
0.5906		15.00
0.5938	19/32	
0.6094	39/64	
0.6102		15.50
0.6250	5/8	
0.6299		16.00
0.6406	41/64	
0.6496		16.50
0.6562	21/32	
0.6693		17.00
0.6719	43/64	
0.6875	11/16	

DECIMAL	FRACTION	METRIC
0.6890		17.50
0.7031	45/64	
0.7087		18.00
0.7188	23/32	
0.7283		18.50
0.7344	47/64	
0.7480		19.00
0.7500	3/4	
0.7656	49/64	
0.7677		19.50
0.7812	25/32	
0.7874		20.0
0.7969	51/64	
0.8071		20.5
0.8125	13/16	
0.8268		21.0
0.8281	53/64	
0.8438	27/32	
0.8465		21.5
0.8594		55/64
0.8661		22.0
0.8750	7/8	
0.8858		22.5
0.8906	57/64	
0.9055		23.0
0.9062	29/32	
0.9219	59/64	
0.9252		23.5
0.9375	15/16	
0.9449		24.0
0.9531	61/64	
0.9646		24.5
0.9688	31/32	
0.9843		25.0
0.9844	63/64	
1.0000	1	
1.0039		25.50
1.0156	1 1/64	
1.0236		26.00
1.0312	1 1/32	
1.0433		26.50
1.0469	1 3/64	
1.0625	1 1/16	
1.0630		27.00
1.0781	1 5/64	

TABLEAU ÉQUIVALENT / TECHNICAL DRILL

DECIMAL	FRACTION	METRIC
1.0827		27.50
1.0938	1 3/32	
1.1024		28.00
1.1094	1 7/64	
1.1220		28.50
1.1250	1 1/8	
1.1406	1 9/64	
1.1417		29.00
1.1562	1 5/32	
1.1614		29.50
1.1719	1 11/64	
1.1811		30.00
1.1875	1 3/16	
1.2008		30.50
1.2031	1 13/64	
1.2188	1 7/32	
1.2205		31.00
1.2344	1 15/64	
1.2402		31.50
1.2500	1 1/4	
1.2598		32.00
1.2656	1 17/64	
1.2795		32.50
1.2812	1 9/32	
1.2969	1 19/64	
1.2992		33.0
1.3125	1 5/16	
1.3189		33.50
1.3281	1 21/64	
1.3386		34.0
1.3438	1 11/32	
1.3583		34.5
1.3594	1 23/64	
1.3750	1 3/8	
1.3780		35.0
1.3906	1 25/64	
1.3976		35.5
1.4062	1 13/32	
1.4173		36.0
1.4219	1 27/64	
1.4370		36.5
1.4375	1 7/16	
1.4531	1 29/64	
1.4567		37.0
1.4688	1 15/32	

DECIMAL	FRACTION	METRIC
1.4764		37.5
1.4844	1 31/64	
1.4961		38.0
1.5000	1 1/2	
1.5156	1 33/64	
1.5157		38.50
1.5312	1 17/32	
1.5354		39.00
1.5469	1 35/64	
1.5551		39.50
1.5625	1 9/16	
1.5748		40.00
1.5781	1 37/64	
1.5938	1 19/32	
1.5945		40.50
1.6094	1 39/64	
1.6142		41.00
1.6250	1 5/8	
1.6339		41.50
1.6406	1 41/64	
1.6535		42.00
1.6562	1 21/32	
1.6719	1 43/64	
1.6732		42.50
1.6875	1 11/16	
1.6929		43.00
1.7031	1 45/64	
1.7126		43.50
1.7188	1 23/32	
1.7323		44.00
1.7344	1 47/64	
1.7500	1 3/4	
1.7520		44.50
1.7656	1 49/64	
1.7717		45.00
1.7812	1 25/32	
1.7913		45.50
1.7969	1 51/64	
1.8110		46.00
1.8125	1 13/16	
1.8281	1 53/64	
1.8307		46.50
1.8438	1 27/32	
1.8504		47.00
1.8594	1 55/64	

TABLEAU ÉQUIVALENT / TECHNICAL DRILL

DECIMAL	FRACTION	METRIC
1.8701		47.50
1.8750	1 7/8	
1.8898		48.00
1.8906	1 57/64	
1.9062	1 29/32	
1.9094		48.50
1.9219	1 59/64	
1.9291		49.00
1.9375	1 15/16	
1.9488		49.50
1.9531	1 61/64	
1.9685		50.00
1.9688	1 31/32	
1.9844	1 63/64	
1.9882		50.50
2.0000	2	

SPLIT POINT



Tel.: (819) 346-2903 / (888) 345-2903 Fax.: (819) 346-3389

Email: distributeur@boulonsestrie.com

INFO TECHNIQUE J (T-12)



POINTE
135 DEGRÉS

SUPERBA

135 DEGRES
SPLIT POINT

"BLACK OXYDE & GOLD FINISH"

NOTRE CODE	DIAMÈTRE	DIA. EN DÉCIMALE	LONG. TOTALE	LONG.FLUTE	QTÉ/PQT
OUR CODE	DIAMETER	DECIMAL DIA.	OVERALL LENGTH	FLUTE LENGTH	QTY/PCK
MF200002	1/64	.0156			12
MF200003	1/32	.0312			12
MF200005	3/64	.0469			12
MF200006	1/16	.0625	1 7/8	7/8	12
MF200008	5/64	.0781	2	1	12
MF200009	3/32	.0938	2 1/4	1 1/4	12
MF200011	7/64	.1094	2 5/8	1 1/2	12
MF200012	1/8	.1250	2 3/4	1 5/8	12
MF200014	9/64	.1406	2 7/8	1 3/4	12
MF200016	5/32	.1562	3 1/8	2	12
MF200017	11/64	.1719	3 1/4	2 1/8	12
MF200018	3/16	.1875	3 1/2	2 5/16	12
MF200020	13/64	.2031	3 5/8	2 7/16	12
MF200022	7/32	.2188	3 3/4	2 1/2	12
MF200023	15/64	.2344	3 7/8	2 5/8	12
MF200025	1/4	.2500	4	2 3/4	12
MF200027	17/64	.2656	4 1/8	2 7/8	6
MF200028	9/32	.2812	4 1/4	2 5/16	6
MF200030	19/64	.2969	4 3/8	3 1/16	6
MF200031	5/16	.3125	4 1/2	3 3/16	6
MF200033	21/64	.3281	4 5/8	3 5/16	6
MF200034	11/32	.3438	4 3/4	3 7/16	6
MF200036	23/64	.3594	4 7/8	3 1/2	6
MF200037	3/8	.3750	5	3 5/8	6
MF200039	25/64	.3906	5 1/8	3 3/4	6
MF200041	13/32	.4062	5 1/4	3 7/8	6
MF200042	27/64	.4219	5 3/8	3 15/16	6
MF200043	7/16	.4375	5 1/2	4 1/16	6
MF200045	29/64	.4531	5 5/8	4 3/16	6
MF200047	15/32	.4688	5 3/4	4 5/16	6
MF200049	31/64	.4844	5 7/8	4 3/8	6
MF200050	1/2	.5000	6	4 1/2	6

MÈCHES À
EMBOÛT RÉDUIT 1/2"

1/2" REDUCED SHANK
DRILLS



POINTE
118 DEGRÉS

118 DEGRES
SPLIT POINT

SUPERBA SYLVER & DEMING

"BLACK OXYDE & GOLD FINISH"

NOTRE CODE	DIAMÈTRE	DIA. EN DÉCIMALE	LONG. TOTALE	LONG.FLUTE	QTÉ/PQT
OUR CODE	DIAMETER	DECIMAL DIA.	OVERALL LENGTH	FLUTE LENGTH	QTY/PCK
MF200515	33/64	.5156	6	3 7/8	1
MF200531	17/32	.5312	6	3 7/8	1
MF200562	9/16	.5625	6	3 7/8	1
MF200578	37/64	.5781	6	3 7/8	1
MF200593	19/32	.5938	6	3 7/8	1
MF200609	39/64	.6094	6	3 7/8	1
MF200625	5/8	.6250	6	3 7/8	1
MF200656	21/32	.6562	6	3 7/8	1
MF200687	11/16	.6875	6	3 7/8	1
MF200718	23/32	.7188	6	3 7/8	1
MF200734	47/64	.7344	6	3 7/8	1
MF200750	3/4	.7500	6	3 7/8	1
MF200815	13/16	.8152	6	3 7/8	1
MF200843	27/32	.8438	6	3 7/8	1
MF200859	55/64	.8594	6	3 7/8	1
MF200875	7/8	.8750	6	3 7/8	1
MF200890	57/64	.8906	6	3 7/8	1
MF200906	29/32	.9062	6	3 7/8	1
MF200937	15/16	.9375	6	3 7/8	1
MF200953	61/64	.9531	6	3 7/8	1
MF200968	31/32	.9688	6	3 7/8	1
MF200984	63/64	.9844	6	3 7/8	1
MF201000	1	1.0000	6	3 7/8	1
MF201062	1 1/16	1.0625	6	3 7/8	1
MF201093	1 3/32	1.0938	6	3 7/8	1
MF201187	1 3/16	1.1875	6	3 7/8	1
MF201250	1 1/4	1.2500	6	3 7/8	1
MF201315	1 5/16	1.3125	6	3 7/8	1



Tel.: (819) 346-2903 / (888) 345-2903 Fax.: (819) 346-3389

Email: distributeur@boulonstrie.com

POINTE
118 DEGRÉS

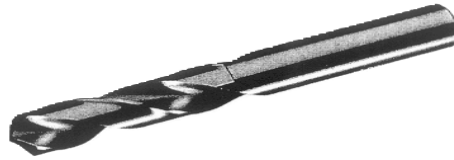

118 DEGRES
SPLIT POINT

"BRIGHT FINISH"

NOTRE CODE	DIAMÈTRE	DIA. EN DÉCIMALE	LONG. TOTALE	LONG.FLUTE
OUR CODE	DIAMETER	DECIMAL DIA.	OVERALL LENGTH	FLUTE LENGTH
MF100006	1/16	.0625	1 5/8	5/8
MF100007	5/64	.0781	1 11/16	11/16
MF100009	3/32	.0938	1 3/4	3/4
MF100011	7/64	.1094	1 13/16	13/16
MF100014	9/64	.1406	1 15/16	15/16
MF100016	5/32	.1562	2 1/16	1
MF100017	11/64	.1719	2 1/8	1 11/16
MF100018	3/16	.1875	2 3/16	1 1/8
MF100020	13/64	.2031	2 1/4	1 3/16
MF100022	7/32	.2188	2 3/8	1 1/4
MF100023	15/64	.2344	2 7/16	1 5/16
*****	1/4	.2500	2 1/2	1 3/8
MF100027	17/64	.2656	2 5/8	1 7/16
MF100028	9/32	.2812	2 11/16	1 1/2
MF100030	19/64	.2969	2 3/4	1 9/16
MF100031	5/16	.3125	2 13/16	1 5/8
MF100033	21/64	.3281	2 15/16	1 11/16
MF100034	11/32	.3438	3	1 11/16
MF100035	23/64	.3594	3 1/16	1 3/4
*****	3/8	.3750	3 1/8	1 13/16
MF100040	25/64	.3906	3 1/4	1 7/8
MF100041	13/32	.4062	3 5/16	1 15/16
MF100042	27/64	.4219	3 3/8	2
MF100044	7/16	.4375	3 7/16	2 11/16
MF100045	29/64	.4531	3 9/16	2 1/8
MF100047	15/32	.4688	3 5/8	2 1/8
MF100048	31/64	.4844	3 11/16	2 13/16
MF100050	1/2	.500	3 3/4	2 1/4

AUTRES DIMENSIONS DISPONIBLES / OTHER DIMENSIONS ARE AVAILABLE



Tel.: (819) 346-2903 / (888) 345-2903 Fax.: (819) 346-3389

Email: distributeur@boulonstrie.com

MÈCHES MESURE
EN LETTRE

LETTER SIZE
DRILL BITS

POINTE
135 DEGRÉS



135 DEGRES
SPLIT POINT

"BLACK OXYDE FINISH"

NOTRE CODE	DIM. EN LETTRE	DIA. EN DÉCIMALE	LONG. TOTALE	LONG.FLUTE	QTÉ/PQT
OUR CODE	LETTER SIZE	DECIMAL DIA.	OVERALL LENGTH	FLUTE LENGTH	QTY/PCK
MF110001	A	.2340	3 7/8	2 5/8	12
MF110002	B	.2380	4	2 3/4	12
MF110003	C	.2420	4	2 3/4	12
MF110004	D	.2460	4	2 3/4	12
MF110005	E	.2500	4	2 3/4	12
MF110006	F	.2570	4 1/8	2 7/8	12
MF110007	G	.2610	4 1/8	2 7/8	6
MF110008	H	.2660	4 1/8	2 7/8	6
MF110009	I	.2720	4 1/8	2 7/8	6
MF110010	J	.2770	4 1/8	2 7/8	6
MF110011	K	.2810	4 1/4	2 15/16	6
MF110012	L	.2900	4 1/4	2 15/16	6
MF110013	M	.2950	4 3/8	3 1/16	6
MF110014	N	.3020	4 3/8	3 1/16	6
MF110015	O	.3160	4 1/2	3 3/16	6
MF110016	P	.3230	4 5/8	3 5/16	6
MF110017	Q	.3320	4 3/4	3 7/16	6
MF110018	R	.3390	4 3/4	3 7/16	6
MF110019	S	.3480	4 7/8	3 1/2	6
MF110020	T	.3580	4 7/8	3 1/2	6
MF110021	U	.3680	5	3 5/8	6
MF110022	V	.3770	5	3 5/8	6
MF110023	W	.3860	5 1/8	3 3/4	6
MF110024	X	.3970	5 1/8	3 3/4	6
MF110025	Y	.4040	5 1/4	3 7/8	6
MF110026	Z	.4130	5 1/4	3 7/8	6



Tel.: (819) 346-2903 / (888) 345-2903 Fax.: (819) 346-3389

Email: distributeur@boulonstrie.com

MÈCHES EN
ACIER RAPIDE
MESURE EN NUMÉRO

HIGH SPEED STEEL
DRILL BITS
NUMBER SIZE



POINTE

135 DEGRES

135 DEGRÉS

"BLACK OXYDE FINISH"

SPLIT POINT

NOTRE CODE	DIA. EN NUMÉRO	DIA. EN DÉCIMALE	LONG. TOTALE	LONG. FLUTE	QTÉ/PQT
OUR CODE	NUMBER DIA.	DECIMAL DIA.	OVERALL LENGTH	FLUTE LENGTH	QTY/PCK
MF500001	1	.2280	3 7/8	2 5/8	12
MF500002	2	.2210	3 7/8	2 5/8	12
MF500003	3	.2130	3 3/4	2 1/2	12
MF500004	4	.2090	3 3/4	2 1/2	12
MF500005	5	.2055	3 3/4	2 1/2	12
MF500006	6	.2040	3 3/4	2 1/2	12
MF500007	7	.2010	3 5/8	2 7/16	12
MF500008	8	.1990	3 5/8	2 7/16	12
MF500009	9	.1960	3 5/8	2 7/16	12
MF500010	10	.1935	3 5/8	2 7/16	12
MF500011	11	.1910	3 1/2	2 5/16	12
MF500012	12	.1890	3 1/2	2 5/16	12
MF500013	13	.1850	3 1/2	2 5/16	12
MF500014	14	.1820	3 3/8	2 3/16	12
MF500015	15	.1800	3 3/8	2 3/16	12
MF500016	16	.1770	3 3/8	2 3/16	12
MF500017	17	.1730	3 3/8	2 3/16	12
MF500018	18	.1695	3 1/4	2 1/8	12
MF500019	19	.1660	3 1/4	2 1/8	12
MF500020	20	.1610	3 1/4	2 1/8	12
MF500021	21	.1590	3 1/4	2 1/8	12
MF500022	22	.1570	3 1/8	2	12
MF500023	23	.1540	3 1/8	2	12
MF500024	24	.1520	3 1/8	2	12
MF500025	25	.1495	3	1 7/8	12
MF500026	26	.1470	3	1 7/8	12
MF500027	27	.1440	3	1 7/8	12
MF500028	28	.1405	2 7/8	1 3/4	12
MF500029	29	.1360	2 7/8	1 3/4	12



Tel.: (819) 346-2903 / (888) 345-2903 Fax.: (819) 346-3389

Email: distributeur@boulonstrie.com

MÈCHES EN
ACIER RAPIDE
MESURE EN NUMÉRO

HIGH SPEED STEEL
DRILL BITS
NUMBER SIZE



POINTE

135 DEGRES

135 DEGRÉS

"BLACK OXYDE FINISH"

SPLIT POINT

NOTRE CODE	DIA. EN NUMÉRO	DIA. EN DÉCIMALE	LONG. TOTALE	LONG. FLUTE	QTÉ/PQT
OUR CODE	NUMBER DIA.	DECIMAL DIA.	OVERALL LENGTH	FLUTE LENGTH	QTY/PCK
MF500030	30	.1285	2 3/4	1 5/8	12
MF500031	31	.1200	2 3/4	1 5/8	12
MF500032	32	.1160	2 3/4	1 5/8	12
MF500033	33	.1130	2 5/8	1 1/2	12
MF500034	34	.1110	2 5/8	1 1/2	12
MF500035	35	.1100	2 5/8	1 1/2	12
MF500036	36	.1065	2 1/2	1 7/16	12
MF500037	37	.1040	2 1/2	1 7/16	12
MF500038	38	.1015	2 1/2	1 7/16	12
MF500039	39	.0995	2 3/8	1 3/8	12
MF500040	40	.0980	2 3/8	1 3/8	12
MF500041	41	.0960	2 3/8	1 3/8	12
MF500042	42	.0935	2 1/4	1 1/4	12
MF500043	43	.0890	2 1/4	1 1/4	12
MF500044	44	.0860	2 1/8	1 1/8	12
MF500045	45	.0820	2 1/8	1 1/8	12
MF500046	46	.0810	2	1 1/8	12
MF500047	47	.0785	2	1	12
MF500048	48	.0760	2	1	12
MF500049	49	.0730	2	1	12
MF500050	50	.0700	2	1	12
MF500051	51	.0670	2	1	12
MF500052	52	.0635	1 7/8	7/8	12
MF500053	53	.0595	1 7/8	7/8	12
MF500054	54	.0550	1 7/8	7/8	12
MF500055	55	.0520	1 7/8	7/8	12
MF500056	56	.0465	1 3/4	3/4	12
MF500057	57	.0430	1 3/4	3/4	12



Tel.: (819) 346-2903 / (888) 345-2903 Fax.: (819) 346-3389

Email: distributeur@boulonstrie.com

MÈCHES EN
ACIER RAPIDE
MESURE EN NUMÉRO

HIGH SPEED STEEL
DRILL BITS
NUMBER SIZE



POINTE
135 DEGRÉS

135 DEGRES
SPLIT POINT

"BLACK OXYDE FINISH"

NOTRE CODE	DIA. EN NUMÉRO	DIA. EN DÉCIMALE	LONG. TOTALE	LONG. FLUTE	QTÉ/PQT
OUR CODE	NUMBER DIA.	DECIMAL DIA.	OVERALL LENGTH	FLUTE LENGTH	QTY/PCK
MF500058	58	.0420	1 5/8	11/16	12
MF500059	59	.0410	1 5/8	11/16	12
MF500060	60	.0400	1 5/8	11/16	12
MF500061	61	.0390	1 5/8	11/16	12
MF500062	62	.0380	1 1/2	5/8	12
MF500063	63	.0370	1 1/2	5/8	12
MF500064	64	.0360	1 1/2	5/8	12
MF500065	65	.0350	1 1/2	5/8	12
MF500066	66	.0330	1 3/8	1/2	12
MF500067	67	.0320	1 3/8	1/2	12
MF500068	68	.0310	1 3/8	1/2	12
MF500069	69	.0292	1 3/8	1/2	12
MF500070	70	.0280	1 1/4	3/8	12
MF500071	71	.0260	1 1/4	3/8	12
MF500072	72	.0250	1 1/8	5/16	12
MF500073	73	.0240	1 1/8	5/16	12
MF500074	74	.0225	1	1/4	12
MF500075	75	.0210	1	1/4	12
MF500076	76	.0200	7/8	3/16	12
MF500077	77	.0180	7/8	3/16	12
MF500078	78	.0160	7/8	3/16	12
MF500079	79	.0145	3/4	1/8	12
MF500080	80	.0135	3/4	1/8	12



Tel.: (819) 346-2903 / (888) 345-2903 Fax.: (819) 346-3389

Email: distributeur@boulonstrie.com

POINTE
118 DEGRÉS



118 DEGRES
SPLIT POINT

"BRIGHT FINISH"

NOTRE CODE	DIAMÈTRE	DIA. EN DÉCIMALE	LONG. TOTALE	LONG.FLUTE
OUR CODE	DIAMETER	DECIMAL DIA.	OVERALL LENGTH	FLUTE LENGTH
MF230010	1.0 mm	.0394	41 mm	18 mm
MF230015	1.5 mm	.0591	48 mm	22 mm
MF230019	1.9 mm	.0748	51 mm	25 mm
MF230020	2.0 mm	.0787	54 mm	29 mm
MF230025	2.5 mm	.0984	60 mm	35 mm
MF230030	3.0 mm	.1180	70 mm	41 mm
MF230032	3.2 mm	.1260	70 mm	41 mm
MF230033	3.3 mm	.1299	73 mm	45 mm
MF230035	3.5 mm	.1378	73 mm	45 mm
MF230040	4.0 mm	.1575	83 mm	54 mm
MF230042	4.2 mm	.1654	83 mm	54 mm
MF230045	4.5 mm	.1772	86 mm	56 mm
MF230048	4.8 mm	.1890	89 mm	59 mm
MF230050	5.0 mm	.1969	92 mm	62 mm
MF230051	5.1 mm	.2008	92 mm	62 mm
MF230055	5.5 mm	.2165	95 mm	64 mm
MF230060	6.0 mm	.2362	102 mm	70 mm
MF230065	6.5 mm	.2559	105 mm	73 mm
MF230068	6.8 mm	.2677	105 mm	73 mm
MF230070	7.0 mm	.2756	105 mm	73 mm
MF230075	7.5 mm	.2953	111 mm	78 mm
MF230079	7.9 mm	.3110	114 mm	81 mm
MF230080	8.0 mm	.3150	114 mm	81 mm
MF230085	8.5 mm	.3346	121 mm	87 mm
MF230090	9.0 mm	.3543	124 mm	89 mm
MF230095	9.5 mm	.3740	127 mm	92 mm
MF230100	10 mm	.3937	130 mm	95 mm
MF230105	10.5 mm	.4134	137 mm	100 mm
MF230110	11 mm	.4180	140 mm	103 mm



MÈCHES EN
ACIER RAPIDE

MÉTRIQUE / METRIC

HIGH SPEED STEEL
DRILL BITS

POINTE
118 DEGRÉS



118 DEGRES
SPLIT POINT

"BRIGHT FINISH"

NOTRE CODE	DIAMÈTRE	DIA. EN DÉCIMALE	LONG. TOTALE	LONG.FLUTE
OUR CODE	DIAMETER	DECIMAL DIA.	OVERALL LENGTH	FLUTE LENGTH
MF230115	11.5 mm	.4528	143 mm	106 mm
MF230120	12.0 mm	.4724	150 mm	111 mm
MF230129	12.5 mm	.2047	152 mm	114 mm
MF230130	13.0 mm	.5118	152 mm	144 mm
MF230135	13.5 mm	.5315	168 mm	122 mm
MF230140	14.0 mm	.5512	168 mm	122 mm
MF230150	15.0 mm	.5906	181 mm	132 mm
MF230160	16.0 mm	.6299	181 mm	132 mm

AUTRES DIMENSIONS DISPONIBLES/OTHER DIMENSIONS AVAILABLE



Tel.: (819) 346-2903 / (888) 345-2903 Fax.: (819) 346-3389
Email: distributeur@boulonsestrie.com

Mèches cobalt / Cobalt Drill

- ◆ Spécialement conçu pour percer l'acier inoxydable et les abrasifs
- ◆ Specially designed to pierce stainless steel and abrasive

- ◆ Rockwell hardness : 66-68

- ◆ 135 degrés commence à percer immédiatement
- ◆ 135 degrees start to pierce immediately

- ◆ Conçu pour exécuter des gros travaux
- ◆ Designed to carry out hard work

Mèches titanium / titanium Drill

- ◆ Idéal pour percer le carbone et les alliages d'acier
- ◆ Perfect to pierce carbon and alloy steel

- ◆ Non recommandé pour le titanium et pour l'alliage de titanium
- ◆ Not recommended for titanium or titanium alloy

- ◆ 135 degrés commence à percer immédiatement
- ◆ 135 degrees start to pierce immediately

- ◆ Donne un meilleur rendement de vos outils
- ◆ Give a better output from your tools

POINTE
135 DEGRÉS



135 DEGRES
SPLIT POINT

"GOLD FINISH"

NOTRE CODE	DIAMÈTRE	DIA. EN DÉCIMALE	LONG. TOTALE	LONG.FLUTE	QTÉ/BTE
OUR CODE	DIAMETER	DECIMAL DIA.	OVERALL LENGTH	FLUTE LENGTH	QTY/BOX
MF230062	1/16	.0625	1 7/8	7/8	12
MF230078	5/64	.0781	2	1	12
MF230093	3/32	.0938	2 1/4	1 1/4	12
MF230109	7/64	.1094	2 5/8	1 1/2	12
MF230125	1/8	.1250	2 3/4	1 5/8	12
MF230141	9/64	.1406	2 7/8	1 3/4	12
MF230156	5/32	.1562	3 1/8	2	12
MF230172	11/64	.1719	3 1/4	2 1/8	12
MF230187	3/16	.1875	3 1/2	2 5/16	12
MF230203	13/64	.2031	3 5/8	2 7/16	12
MF230218	7/32	.2188	3 3/4	2 1/2	12
MF230234	15/64	.2344	3 7/8	2 5/8	12
MF230250	1/4	.2500	4	2 3/4	12
MF230265	17/64	.2656	4 1/8	2 7/8	6
MF230281	9/32	.2812	4 1/4	2 5/16	6
MF230296	19/64	.2964	4 3/8	3 1/16	6
MF230315	5/16	.3125	4 1/2	3 3/16	6
MF230328	21/64	.3281	4 5/8	3 5/16	6
MF230343	11/32	.3438	4 3/4	3 7/16	6
MF230359	23/64	.3594	4 7/8	3 1/2	6
MF230375	3/8	.3750	5	3 5/8	6
MF230390	25/64	.3906	5 1/8	3 3/4	6
MF230406	13/32	.4062	5 1/4	3 7/8	6
MF230421	27/64	.4219	5 3/8	3 15/16	6
MF230437	7/16	.4375	5 1/2	4 1/16	6
MF230453	29/64	.4531	5 5/8	4 3/16	6
MF230468	15/32	.4688	5 3/4	4 5/16	6
MF230484	31/64	.4844	5 7/8	4 3/8	6
MF230500	1/2	.5000	6	4 1/2	6



Tel.: (819) 346-2903 / (888) 345-2903 Fax.: (819) 346-3389

Email: distributeur@boulonstrie.com

POINTE
135 DEGRÉS



135 DEGRES
SPLIT POINT

"BRIGHT GOLD FINISH"

NOTRE CODE	DIAMÈTRE	DIA. EN DÉCIMALE	LONG. TOTALE	LONG. FLUTE	QTÉ/PQT
OUR CODE	DIAMETER	DECIMAL DIA.	OVERALL LENGTH	FLUTE LENGTH	QTY/PCK
MF220006	1/16	.0625	1 7/8	7/8	12
*****	5/64	.0781	2	1	12
MF220009	3/32	.0938	2 1/4	1 1/4	12
MF220010	7/64	.1094	2 5/8	1 1/2	12
MF220012	1/8	.1250	2 3/4	1 5/8	12
MF220013	9/64	.1406	2 7/8	1 3/4	12
MF220014	5/32	.1562	3 1/8	2	12
MF220015	11/64	.1719	3 1/4	2 1/8	12
MF220016	3/16	.1875	3 1/2	2 5/16	12
MF220017	13/64	.2031	3 5/8	2 7/16	12
MF220018	7/32	.2188	3 3/4	2 1/2	12
*****	15/64	.2344	3 7/8	2 5/8	12
MF220025	1/4	.2500	4	2 3/4	12
MF220026	17/64	.2656	4 1/8	2 7/8	6
MF220027	9/32	.2812	4 1/4	2 5/16	6
*****	19/64	.2969	4 3/8	3 1/16	6
MF220031	5/16	.3125	4 1/2	3 3/16	6
MF220032	21/64	.3281	4 5/8	3 5/16	6
MF220034	11/32	.3438	4 3/4	3 7/16	6
*****	23/64	.3594	4 7/8	3 1/2	6
MF220037	3/8	.3750	5	3 5/8	6
MF220038	25/64	.3906	5 1/8	3 3/4	6
*****	13/32	.4062	5 1/7	3 7/8	6
*****	27/64	.4219	5 3/8	3 15/16	6
MF220043	7/16	.4375	5 1/2	4 1/16	6
*****	29/64	.4531	5 5/8	4 3/16	6
*****	15/32	.4688	5 3/4	4 5/16	6
*****	31/64	.4844	5 7/8	4 3/8	6
MF220050	1/2	.5000	6	4 1/2	6



"BLACK OXYDE"



AUTRES DIMENSIONS DISPONIBLES / OTHER DIMENSIONS ARE AVAILABLE

NOTRE CODE	DIAMÈTRE	LONGUEUR TOTALE	DIAMÈTRE TIGE	QTÉ/PQT
OUR CODE	DIAMETER	OVERALL LENGTH	SHANK DIAMETER	QTY/PCK
MC012025	1/8	3	1/8	1
MC018035	3/16	3 1/2	3/16	1
MC018040	3/16	4	3/16	1
MC018060	3/16	6	3/16	1
MC025040	1/4	4	1/4	1
MC025060	1/4	6	1/4	1
MC025130	1/4	13	1/4	1
MC031060	5/16	6	1/4	1
MC031130	5/16	13	1/4	1
MC037040	3/8	4	1/4	1
MC037060	3/8	6	1/4	1
MC037130	3/8	13	1/4	1
MC043060	7/16	6	1/4	1
MC050060	1/2	6	3/8	1
MC050130	1/2	13	3/8	1
MC056060	9/16	6	3/8	1
MC062060	5/8	6	3/8	1
MC062130	5/8	13	3/8	1
MC075060	3/4	6	1/2	1
MC087060	7/8	6	1/2	1
MC090060	1	6	1/2	1
MC090180	1	18	1/2	1

MÈCHES À CIMENT



MASONRY DRILLS

TAPCON

NOTRE CODE	DESCRIPTION	QTÉ/BTE
OUR CODE	DESCRIPTION	QTY/BOX
MT915035	5/32 X 3 1/2	1
MT915045	5/32 X 4 1/2	1
MT915055	5/32 X 5 1/2	1
MT918035	3/16 X 3 1/2	1
MT918045	3/16 X 4 1/2	1
MT918055	3/16 X 5 1/2	1
MT918065	3/16 X 6 1/2	1
MT918075	3/16 X 7 1/2	1



NOTRE CODE	DIA.	LONGUEUR TOTALE	LONGUEUR UTILISABLE
OUR CODE	DIA.	OVERALL LENGTH	DRILLING DEPTH
*****	3/16	4 1/2"	2"
MC501806	3/16	6 1/4"	4"
*****	3/16	8 1/4"	6"
*****	3/16	10"	8"
*****	3/16	12"	10"
*****	3/16	14"	12"
*****	3/16	16"	14"
MC502504	1/4	4 1/2"	2"
MC502506	1/4	6 1/4"	4"
MC502508	1/4	8 1/4"	6"
*****	1/4	11"	8"
*****	1/4	12"	10"
*****	1/4	14"	12"
*****	1/4	16"	14"
MC503106	5/16	6 1/4"	4"
*****	5/16	12"	10"
MC503706	3/8	6 1/4"	4"
*****	3/8	10 1/4"	8"
MC503712	3/8	12 1/4"	10"
*****	3/8	18"	16"
*****	3/8	24"	22"
*****	7/16	6 1/4"	4"
*****	7/16	9"	6"
*****	7/16	12 1/4"	10"
*****	7/16	18"	16"
MC505006	1/2	6 1/4"	4"
MC505010	1/2	10 1/4"	8"
MC505012	1/2	12 1/4"	10"





NOTRE CODE	DIA.	LONGUEUR TOTALE	LONGUEUR UTILISABLE
OUR CODE	DIA.	OVERALL LENGTH	DRILLING DEPTH
*****	1/2	18"	16"
*****	1/2	24"	22"
*****	9/16	6 1/4"	4"
*****	9/16	2 1/4"	10"
*****	9/16	18"	16"
MC506206	5/8	6 1/4"	4"
MC506208	5/8	8"	6"
MC506212	5/8	12"	10"
*****	5/8	18"	16"
*****	5/8	24"	22"
*****	11/16	10"	8"
*****	11/16	18"	16"
*****	3/4	8"	6"
*****	3/4	10"	8"
MC507512	3/4	12"	10"
MC507518	3/4	18"	16"
*****	3/4	24"	22"
*****	7/8	8"	6"
*****	7/8	12"	10"
*****	7/8	18"	14"
*****	1	10"	8"
*****	1	18"	16"

AUTRES DIMENSIONS DISPONIBLE / OTHER DIMENSIONS ARE AVAILABLE





"WING TIP"

NOTRE CODE	DIAMÈTRE EN FRACTION	DIA. TIGE	LONGUEUR TOTALE	QTÉ/PQT
OUR CODE	FRACTION DIAMETER	SHANK DIA.	OVERALL LENGTH	QTY/PCK
MF000250	1/4	3/16	6"	6
*****	5/16	3/16	6"	6
MF000375	3/8	1/4	6"	6
MF000437	7/16	1/4	6"	6
MF000500	1/2	1/4	6"	6
*****	9/16	1/4	6"	6
MF000625	5/8	1/4	6"	6
MF000687	11/16	1/4	6"	6
MF000750	3/4	1/4	6"	6
MF000812	13/16	1/4	6"	6
MF000875	7/8	1/4	6"	6
MF000937	15/16	1/4	6"	6
MF001000	1	1/4	6"	6
*****	1 1/8	1/4	6"	6
MF001250	1 1/4	1/4	6"	6
MF001375	1 3/8	1/4	6"	6
MF001500	1 1/2	1/4	6"	6

MÈCHES EN ACIER RAPIDE

HIGH SPEED STEEL DRILLS

TIGE RÉDUITE 1/4"

REDUCED SHANK 1/4"



NOTRE CODE	DIAMÈTRE EN FRACTION	DIA. TIGE	LONGUEUR TOTALE	LG FLUTE
OUR CODE	FRACTION DIAMETER	SHANK DIA.	OVERALL LENGTH	FLUTE LGT
MF200051	25/64	1/4	5 1/8	3 3/4
MF200052	13/32	1/4	5 1/4	3 1/8
MF200053	27/64	1/4	5 3/8	3 15/16
MF200054	7/16	1/4	5 1/2	4 1/16
MF200055	29/64	1/4	5 5/8	4 3/16
MF200056	15/32	1/4	5 3/4	4 5/16
MF200057	31/64	1/4	5 7/8	4 3/8
MF200058	1/2	1/4	6"	4 1/2



**ENSEMBLE DE MÈCHES ET EXTRACTEURS /
DRILLS AND EXTRACTORS SET**

**MÈCHES/DRILLS : 5/64, 7/64, 5/32, 1/4, 17/64
(SPIRAL)**

EXTRACTEURS / EXTRACTORS: # 1 À 5

PART # MF199996

ENSEMBLE DE MÈCHES / DRILL SET

ACIER RAPIDE / HSS

1/16 À 3/8 (21 PCES)

135 DEGRÉS / SPLIT POINT

PART # MF199997

ENSEMBLE DE MÈCHES / DRILL SET

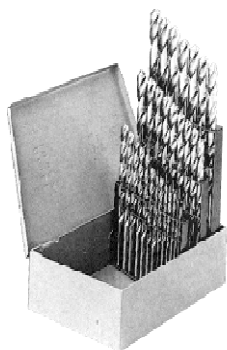

ENSEMBLE DE MÈCHES / DRILL SET

ACIER RAPIDE / HSS

1/16 À 1/2 (29 PCES)

135 DEGRÉS / SPLIT POINT

PART # MF200000

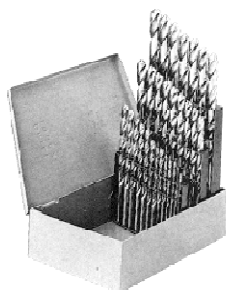

ENSEMBLE DE MÈCHES / DRILL SET

TITANIUM

1/16 À 1/2 (29 PCES)

135 DEGRÉS / SPLIT POINT

PART # MF200001

AUTRES ENSEMBLES DISPONIBLES / OTHER KITS AVAILABLE

SUPERBA



Tel.: (819) 346-2903 / (888) 345-2903 Fax.: (819) 346-3389

Email: distributeur@boulonsestrie.com

EXTRACTEURS DE VIS DROIT

STRAIGHT SCREW EXTRACTORS



NOTRE CODE	DESCRIPTION	POUR ENLEVER UNE VIS	DIA. DE LA MÈCHE
OUR CODE	DESCRIPTION	TO REMOVE DIA. SCREW	DRILL SIZE INCH
TG000001	#1	1/4 , 5/16	1/8
TG000002	#2	3/8	3/16
TG000003	#3	7/16	15/64
TG000004	#4	1/2 , 9/16 , 1/8 P	5/16
TG000005	#5	5/8 , 1/4 P	3/8
TG000006	#6	3/4 , 3/8 P	15/32
TG000007	#7	7/8 , 1/2 P	9/16
TG000018	ENS. / SET # 1 À 5	-	-

EXTRACTEURS DE VIS SPIRAL

SPIRAL SCREW EXTRACTORS



NOTRE CODE	DESCRIPTION	POUR ENLEVER UNE VIS	DIA. DE LA MÈCHE
OUR CODE	DESCRIPTION	TO REMOVE DIA. SCREW	DRILL SIZE INCH
TG000011	1	3/32 to 5/32	5/64
TG000012	2	5/32 to 7/32	7/64
TG000013	3	7/32 to 9/32	5/32
TG000014	4	9/32 to 3/8	1/4
*****	5	3/8 to 5/8 and 1/8 et 1/4 P	17/64
TG000017	ENS. / SET # 1 À 5	-	-

AUTRES DIMENSIONS DISPONIBLE / OTHER DIMENSIONS ARE AVAILABLE



Tel.: (819) 346-2903 / (888) 345-2903 Fax.: (819) 346-3389

Email: distributeur@boulonstrie.com

FRAISES
DEUX LÈVRES

END MILLS
TWO FLUTE

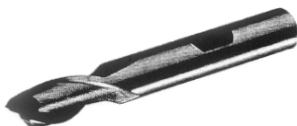

NOTRE CODE	DIA. FRAISE	DIA. TIGE	LONGUEUR DE COUPE
OUR CODE	MILL DIAMETER	SHANK DIA.	LENGTH OF CUT
EM020125	1/8	3/8	3/8
EM020187	3/16	3/8	7/16
EM020250	1/4	3/8	1/2
EM020315	5/16	3/8	9/16
EM020375	3/8	3/8	9/16
EM020437	7/16	3/8	13/16
EM020500	1/2	3/8	13/16
EM020562	9/16	1/2	1 1/8
EM020625	5/8	5/8	1 5/16
EM020687	11/16	1/2	1 5/16
EM020750	3/4	1/2	1 5/16
EM020812	13/16	5/8	1 1/2
EM020875	7/8	5/8	1 1/2
EM021000	1	5/8	1 1/2

AUSSI DISPONIBLE / ALSO AVAILABLE

FRAISES
LÈVRES MULTIPLES

END MILLS
MULTI-FLUTE

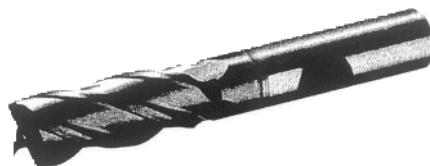

QUATRE LÈVRES / FOUR FLUTE

SIX LÈVRES / SIX FLUTE

...



Tel.: (819) 346-2903 / (888) 345-2903 Fax.: (819) 346-3389
Email: distributeur@boulonsestrie.com

J-20

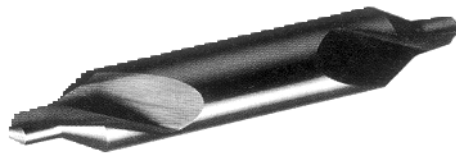

NOTRE CODE	# GRANDEUR	DIA. DU CORPS	LONGUEUR TOTALE
OUR CODE	SIZE NUMBER	BODY DIAMETER	OVERALL LENGTH
MF700001	1	1/8	1 1/4
MF700002	2	3/16	1 7/8
MF700003	3	1/4	2
MF700004	4	5/16	2 1/8
MF700005	5	7/16	2 3/4
MF700006	6	1/2	3
*****	7	5/8	3 1/4
*****	8	3/4	3 1/2

DISPONIBLES SUR DEMANDE
AVAILABLE ON REQUEST

*****MÈCHE À QUEUE CONIQUE

*****TAPER SHANK DRILL



*****MÈCHES CONIQUES SIMPLES

*****SINGLE-FLUTE COUNTERSINKS

&

*****MÈCHES CONIQUES TRIPLES

*****THREE-FLUTE COUNTERSINKS



Tel.: (819) 346-2903 / (888) 345-2903 Fax.: (819) 346-3389

Email: distributeur@boulonsestrie.com

SECTION K

TARAUDS ET FILIÈRES / TAPS AND DIES

INFORMATION TECHNIQUE.....DÉBUT DE LA SECTION
 TECHNICAL INFORMATION.....BEGINNING OF THIS SECTION

	DESCRIPTION	SECTION-PAGE
	TARAUDS À MAIN EN ACIER RAPIDE. HAND TAPS HSS.	K-1
	TARAUDS À MAIN EN ACIER RAPIDE, MÉTRIQUE. HAND TAPS HSS, MÉTRIC.	K-4
	ENS. DE TARAUDS À MAIN EN ACIER RAPIDE. HAND TAP HSS SETS.	K-3
	ENS. DE TARAUDS À MAIN, MÉTRIQUE. HAND TAP HSS METRIC, SETS.	SUR DEMANDE ON REQUEST
	TARAUDS POUR TUYAUX, FILETS NPT. TAPER PIPE TAPS, NPT.	K-5
	TARAUDS POINTE SPIRALE. SPIRAL POINT MACHINE TAPS.	SUR DEMANDE ON REQUEST
	TARAUDS À MAIN FILETS À GAUCHE. LEFT HAND TAPS.	SUR DEMANDE ON REQUEST
	ACCESSOIRES. ACCESSORIES.	SUR DEMANDE ON REQUEST
	FILIÈRES HEXAGONES. HEX RETREADING DIES.	K-6
	FILIÈRES RONDES. ROUND ADJUSTABLE DIES .	K-6
	ALÉSOIRS À LONGUEUR RÉGULIÈRE. REGULAR LENGTH CHUCKING REAMERS.	SUR DEMANDE ON REQUEST
	ALÉSOIRS À TIGE CONIQUE. TAPER SHANK CHUCKING REAMERS.	SUR DEMANDE ON REQUEST
	ALÉSOIRS À FRAISER À TIGE CONIQUE. TAPER SHANK SHORT SERIES COUNTERBORES.	SUR DEMANDE ON REQUEST
	ALÉSOIRS À MAIN. HAND REAMERS.	SUR DEMANDE ON REQUEST
	ACIER À OUTIL CARRÉ AU CARBONE. CARBON STEEL SQUARE TOOL BITS.	SUR DEMANDE ON REQUEST
	ACIER À OUTIL CARRÉ EN ACIER RAPIDE. HSS SQUARE TOOL BIT.	SUR DEMANDE ON REQUEST



DIM.	FLUTES	LONG. TOTALE	LONG. FILET	ÉBAUCHEUR(#1)	INTERMÉD.(#2)	FINISSEUR(#3)
SIZES	FLUTES	OVERALL LGTH	THREAD LGTH	STARTER(#1)	PLUG(#2)	BOTTOMING(#3)
0-80 N.F	2	1-5/8	5/16	TA000080	TA000081	TA000082
1-64 N.C	2	1-11/16	3/8	TA000164	TA000165	TA000166
1-72 N.F	2	1-11/16	3/8	TA000172	TA000173	TA000174
2-56 N.C	3	1-3/4	7/16	TA000256	TA000257	TA000258
2-64 N.F	3	1-3/4	7/16	TA000264	TA000265	TA000266
3-48 N.C	3	1-13/16	1/2	TA000348	TA000349	TA000350
3-56 N.F	3	1-13/16	1/2	TA000356	TA000357	TA000358
4-40 N.C	3	1-7/8	9/16	TA000440	TA000441	TA000442
4-48 N.F	3	1-7/8	9/16	TA000448	TA000449	TA000450
5-40 N.C	3	1-15/16	5/8	TA000540	TA000541	TA000542
5-44 N.F	3	1-15/16	5/8	TA000544	TA000545	TA000546
6-32 N.C	3	2	11/16	TA000632	TA000633	TA000634
6-40 N.F	3	2	11/16	TA000640	TA000641	TA000642
8-32 N.C	4	2-1/8	3/4	TA000832	TA000833	TA000834
8-36 N.F	4	2-1/8	3/4	TA000836	TA000837	TA000838
10-24 N.C	4	2-3/8	7/8	TA001024	TA001025	TA001026
10-32 N.F	4	2-3/8	7/8	TA001032	TA001033	TA001034
12-24 N.C	4	2-3/8	15/16	TA001224	TA001225	TA001226
12-28 N.F	4	2-3/8	15/16	TA001228	TA001229	TA001230
1/4-20 N.C	4	2-1/2	1	TA002520	TA002521	TA002522
1/4-28 N.F	4	2-1/2	1	TA002528	TA002529	TA002530
5/16-18 N.C	4	2-23/32	1-1/8	TA003118	TA003119	TA003120
5/16-24 N.F	4	2-23/32	1-1/8	TA003124	TA003125	TA003126
3/8-16 N.C	4	2-15/16	1-1/4	TA003716	TA003717	TA003718
3/8-24 N.F	4	2-15/16	1-1/4	TA003724	TA003725	TA003726
3/8-32 N.EF	4	2-15/16	1-1/4	60233	60234	TA003734
7/16-14 N.C	4	3-5/32	1-7/16	TA004314	TA004315	TA004316
7/16-20 N.F	4	3-5/32	1-7/16	TA004320	TA004321	TA004322
1/2-13 N.C	4	3-3/8	1-21/32	TA005013	TA005014	TA005015
1/2-20 N.F	4	3-3/8	1-21/32	TA005020	TA005021	TA005022
9/16-12 N.C	4	3-19/32	1-21/32	TA005612	TA005613	TA005614
9/16-18 N.F	4	3-19/32	1-21/32	TA005618	TA005619	TA005620
5/8-11 N.C	4	3-13/16	1-13/16	TA006211	TA006212	TA006213



Tel.: (819) 346-2903 / (888) 345-2903 Fax.: (819) 346-3389

Email: distributeur@boulonsestrie.com



DIM.	FLUTES	LONG. TOTALE	LONG. FILET	ÉBAUCHEUR(#1)	INTERMÉD.(#2)	FINISSEUR(#3)
SIZES	FLUTES	OVERALL LGTH	THREAD LGTH	STARTER(#1)	PLUG(#2)	BOTTOMING(#3)
5/8-18 N.F	4	3-13/16	1-13/16	TA006218	TA006219	55142
3/4-10 N.C	4	4-1/4	2	54838	TA007511	54840
3/4-16 N.F	4	4-1/4	2	TA007516	TA007517	TA007518
7/8-9 N.C	4	4-11/16	2-7/32	TA008709	TA008710	TA008711
7/8-14 N.F	4	4-11/16	2-7/32	TA008714	TA008715	TA008716
1-8 N.C	4	5-1/8	2-1/2	TA009001	TA009002	TA009003
1 1/8-7 N.C	4	5-7/16	2-9/16	TA011207	TA011208	TA011209
1 1/8-12 N.F	4	5-7/16	2-9/16	TA011212	54972	TA011214
1 1/4-7 N.C	4	5-3/4	2-9/16	54994	54995	54996
1 1/4-12 N.F	6	5-3/4	2-9/16	TA012512	TA012513	TA012514
1 3/8-6 N.C	4	6-1/16	3	55027	TA013707	55029
1 3/8-12 N.F	6	6-1/16	3	55030	55031	55032
1 1/2-6 N.C	4	6-3/8	3	TA015006	TA015007	-
1 1/2-12 N.F	6	6-3/8	3	55063	55064	55065





ENS. (# 1,2,3)	NOTRE CODE	ENS. (# 1,2,3)	NOTRE CODE
SET(# 1,2,3)	OUR CODE	SET(# 1,2,3)	OUR CODE
0-80 N.F	TA000083	3/8-24 N.F	TA003727
1-64 N.C	TA000167	3/8-32 N.EF	*****
1-72 N.F	TA000175	7/16-14 N.C	TA004317
2-56 N.C	TA000259	7/16-20 N.F	TA004323
2-64 N.F	TA000267	1/2-13 N.C	TA005016
3-48 N.C	TA000351	1/2-20 N.F	TA005023
3-56 N.F	TA000359	9/16-12 N.C	TA005615
4-40 N.C	TA000443	9/16-18 N.F	*****
4-48 N.F	TA000451	5/8-11 N.C	TA006214
5-40 N.C	TA000543	5/8-18 N.F	*****
5-44 N.F	TA000547	3/4-10 N.C	TA007513
6-32 N.C	TA000635	3/4-16 N.F	TA007519
6-40 N.F	TA000643	7/8-9 N.C	*****
8-32 N.C	TA000835	7/8-14 N.F	TA008717
8-36 N.F	TA000839	1-8 N.C	*****
10-24 N.C	TA001027	1-14 N.F.	*****
10-32 N.F	TA001035	1 1/8-7 N.C	*****
12-24 N.C	TA001227	1 1/8-12 N.F	*****
12-28 N.F	TA001231	1 1/4-7 N.C	*****
1/4-20 N.C	TA002523	1 1/4-12 N.F	*****
1/4-28 N.F	TA002531	1 3/8-7 N.C	*****
5/16-18 N.C	TA0003121	1 3/8-12 N.F	*****
5/16-24 N.F	TA003127	1 1/2-6 N.C	*****
3/8-16 N.C	TA003719	1 1/2-12 N.F	*****

*** TITATIUM DISPONIBLE ***
*** TIN COATED AVAILABLE ***



Tel.: (819) 346-2903 / (888) 345-2903 Fax.: (819) 346-3389

Email: distributeur@boulonsestrie.com



DIM.	FLUTES	LONG. TOTALE	LONG. FILET	EBAUCHEUR(#1)	INTERMÉD.(#2)	FINISSEUR(#3)
SIZES	FLUTES	OVERALL LGTH	THREAD LGTH	STARTER(#1)	PLUG(#2)	BOTTOMING(#3)
M2 X 0.40	3	1-3/4	7/16	TA220045	54074	54075
M2.5 X 0.45	3	1-13/16	1/2	54131	TA220049	54133
M3 X 0.50	3	1-15/16	5/8	TA220050	TA230051	TA220052
M4 X 0.70	4	2-1/8	3/4	TA245075	TA245076	TA245077
M5 X 0.80	4	2-3/8	7/8	TA250080	TA250081	TA250082
M6 X 1.00	4	2-1/2	1	TA260100	TA260101	TA260102
M7 X 1.00	4	2-23/32	1-1/8	TA270078	TA270079	TA270080
M8 X 1.00	4	2-23/32	1-1/8	TA280101	TA280102	TA280202
M8 X 1.25	4	2-23/32	1-1/8	TA280125	TA280126	TA280127
M10 X 1,25	4	2-15/16	1-1/4	TA310011	TA310012	TA310013
M10 X 1.50	4	2-15/16	1-1/4	TA310014	TA310015	TA310016
M12 X 1.75	4	3-3/8	1-21/32	TA312111	TA312112	TA312113
M14 X 1,50	4	3-19/32	1-21/32	TA314197	TA314198	TA314199
M14 X 2.00	4	3-19/32	1-21/32	TA314200	TA314201	TA314202
M16 X 2.00	4	3-13/16	1-13/16	54801	TA316202	54803
M18 X 1.50	4	4-1/32	1-13/16	54825	54826	54827
M18 X 2.50	4	4-1/32	1-13/16	54833	54834	54835
M20 X 1.50	4	4-15/32	2	54856	54857	54858
M20 X 2.50	4	4-15/32	2	54864	54865	54866
M22 X 2.50	4	4-11/16	2-7/32	54880	TA322251	54882
M24 X 2.00	4	4-29/32	2-7/32	54903	54904	54905
M24 X 3.00	4	4-29/32	2-7/32	54907	54908	54909
M30 X 2.00	4	5-7/16	2-9/16	54982	54983	54984
M30 X 3.50	4	5-7/16	2-9/16	54990	54991	54992
M36 X 3.00	4	6-1/16	3	55045	55046	55047
M36 X 4.00	4	6-1/16	3	55049	55050	55051

AUTRES DIMENSIONS DISPONIBLES / OTHER DIMENSIONS ARE AVAILABLE

ENSEMBLES MÉTRIQUES DISPONIBLES SUR DEMANDE / METRIC SETS ARE AVAILABLE ON REQUEST



Tel.: (819) 346-2903 / (888) 345-2903 Fax.: (819) 346-3389

Email: distributeur@boulonsestrie.com



NOTRE CODE	DIAMÈTRE	NOMBRE DE FLUTES	LONGUEUR TOTALE	LONGUEUR FILET
OUR CODE	DIAMETER	NUMBER OF FLUTES	OVERALL LENGTH	THREAD LENGTH
TA100062	1/16-27	4	2 1/8	11/16
TA100125	1/8-27	4	2 1/8	3/4
TA100250	1/4-18	4	2 7/16	1 1/16
TA100375	3/8-18	4	2 9/16	1 1/16
TA100500	1/2-14	4	3 1/8	1 3/8
TA100750	3/4-14	5	3 1/4	1 3/8
*****	1-11 1/2	5	3 3/4	1 3/4
*****	1 1/4-11 1/2	5	4	1 3/4
*****	1 1/2-11 1/2	7	4 1/4	1 3/4
*****	2-11 1/2	7	4 1/2	1 3/4

**** DISPONIBLE SUR DEMANDE ****
**** AVAILABLE ON REQUEST****

TARAUDS À MAIN FILETS À GAUCHE / LEFT HAND TAPS
POINTE SPIRAL / SPIRAL POINT



Tel.: (819) 346-2903 / (888) 345-2903 Fax.: (819) 346-3389
Email: distributeur@boulonsestrie.com

**FILIÈRES
HEXAGONES**  **HEXAGON
RETHREADING DIES**

ACIER CARBONE / CARBON STEEL

NOTRE CODE	DESCRIPTION	PLAT À PLAT	ÉPAIS.
OUR CODE	DESCRIPTION	ACROSS FLAT	THICK
TA500250	1/4-20	19/32	1/4
65602	1/4-28	19/32	1/4
TA500312	5/16-18	11/16	5/16
65605	5/16-24	11/16	5/16
TA500375	3/8-16	25/32	3/8
65607	3/8-24	25/32	3/8
TA500437	7/16-14	7/8	7/16
65609	7/16-20	7/8	7/16
TA500500	1/2-13	1 1/16	1/2
65611	1/2-20	1 1/16	1/2
TA500562	9/16-12	1 1/16	1/2
65613	9/16-18	1 1/16	1/2
65614	5/8-11	1 1/4	5/8
65615	5/8-18	1 1/4	5/8
65616	11/16-11	1 7/16	3/4
65617	11/16-16	1 7/16	3/4
TA500750	3/4-10	1 7/16	3/4
65619	3/4-16	1 7/16	3/4
65620	7/8-9	1 5/8	7/8
65621	7/8-14	1 5/8	7/8
TA501000	1-8	1 13/16	1
65623	1-12	1 13/16	1
65624	1-14	1 13/16	1
65625	1 1/8-7	2	1
65627	1 1/8-12	2	1
65628	1 1/4-7	2 3/16	1
65629	1 1/4-12	2 3/16	1
TA501375	1 3/8-6	2 3/8	1
TA501376	1 3/8-12	2 3/8	1
65632	1 1/2-6	2 9/16	1
65633	1 1/2-12	2 9/16	1

FILIÈRES RONDES  **ADJUSTABLE
ROUND DIES**

HSS

NOTRE CODE	DESCRIPTION	DIA EXT.	ÉPAIS.
OUR CODE	DESCRIPTION	OUTSIDE DIA.	THICK
TA410632	6-32	1	3/8
65789	8-32	1	3/8
65792	10-24	1	3/8
65793	10-32	1	3/8
TA422520	1/4-20	1	3/8
TA422528	1/4-28	1	3/8
65808	5/16-18	1	3/8
65809	5/16-24	1	3/8
65816	3/8-16	1	3/8
65817	3/8-24	1	3/8
65839	1/4-20	1 1/2	1/2
65840	1/4-28	1 1/2	1/2
TA443118	5/16-18	1 1/2	1/2
65845	5/16-24	1 1/2	1/2
65855	3/8-16	1 1/2	1/2
65856	3/8-24	1 1/2	1/2
65875	1/2-13	1 1/2	1/2
TA445020	1/2-20	1 1/2	1/2
65884	5/8-11	1 1/2	1/2
65885	5/8-18	1 1/2	1/2
65946	5/8-11	2	5/8
65947	5/8-18	2	5/8
65957	3/4-10	2	5/8
65958	3/4-16	2	5/8
65966	7/8-9	2	5/8
TA458714	7/8-14	2	5/8

**ACCESSOIRES /
ACCESORIES**



AUTRES DIMENSIONS DISPONIBLES / OTHER DIMENSIONS ARE AVAILABLE

AUSSI DISPONIBLE / ALSO AVAILABLE



ALÉSOIRS À LONGUEUR RÉGULIÈRE / REGULAR LENGTH CHUCKING REAMERS



ALÉSOIRS À TIGE CONIQUE / TAPER SHANK CHUCKING REAMERS



**ALÉSOIRS À FRAISER À TIGE CONIQUE AVEC PILOTES INTERCHANGEABLES (SÉRIE COURTE)
(TAPER SHANK) SHORT SERIES COUNTERBORES WITH INTERCHANGEABLE PILOTS**



ALÉSOIRS À MAIN / HAND REAMERS

**AUTRES MODÈLES D'ALÉSOIRS DISPONIBLES
OTHER REAMERS ARE AVAILABLE**



ACIER À OUTIL CARRÉ ACIER CARBONE / CARBON STEEL SQUARE TOOL BITS



ACIER À OUTIL CARRÉ À ACIER RAPIDE / HSS SQUARE TOOL BITS



Tel.: (819) 346-2903 / (888) 345-2903 Fax.: (819) 346-3389



Email: distributeur@boulonsestrie.com

K-7

SECTION L

LAMES / BLADES

INFORMATION TECHNIQUE.....DÉBUT DE LA SECTION
 TECHNICAL INFORMATION.....BEGINNING OF THIS SECTION

	DESCRIPTION	SECTION-PAGE
	LAMES POUR SCIE À FER . HACKSAW BLADES.	L-1
	LAME POUR SCIE À FER , POWER. POWER HACKSAW BLADES.	L-1
	LAMES POUR SCIE À FER CIRCULAIRE. BANDSAW BLADES.	L-1
	LAMES POUR SCIE PASSE PARTOUT. RECIPROCATING SAW BLADES.	L-2
	LAMES POUR SCIE SAUTEUSE . JIG SAW BLADES .	L-4
	EMPORTE-PIÈCES. HOLESAWS.	L-5
	MANDRINS. MANDRELS.	L-5
	MÈCHES POUR EMPORTE-PIÈCES. HOLESAWS DRILLS.	L-5
	ENSEMBLES EMPORTE-PIÈCES. HOLESAW KITS.	L-6
	LAMES DE SCIE CIRCULAIRE. CIRCULAR SAW BLADES.	L-8



Tel.: (819) 346-2903 / (888) 345-2903 Fax.: (819) 346-3389
 Email: distributeur@boulonsestrie.com



NOTRE CODE	LONGUEUR	LARGEUR	ÉPAISSEUR	DENTS PAR POUCE
OUR CODE	LENGTH	WIDTH	THICK	TEETH PER INCH
*****	12	1/2	.025	14
OU60018	12	1/2	.025	18
OU60024	12	1/2	.025	24
OU60032	12	1/2	.025	32



HIGH SPEED MOLYBDENUM

NOTRE CODE	LONGUEUR	LARGEUR	ÉPAISSEUR	DENTS PAR POUCE
OUR CODE	LENGTH	WIDTH	THICK	TEETH PER INCH
OU121010	12	1	.050	10
*****	12	1	.050	14
*****	14	1	.050	10
*****	14	1	.050	14
OU141262	14	1 1/4	.062	6
OU141210	14	1 1/4	.062	10

LAME POUR SCIE
À FER CIRCULAIRE
PLUSIEURS
DIMENSIONS
DISPONIBLES
SUR DEMANDE

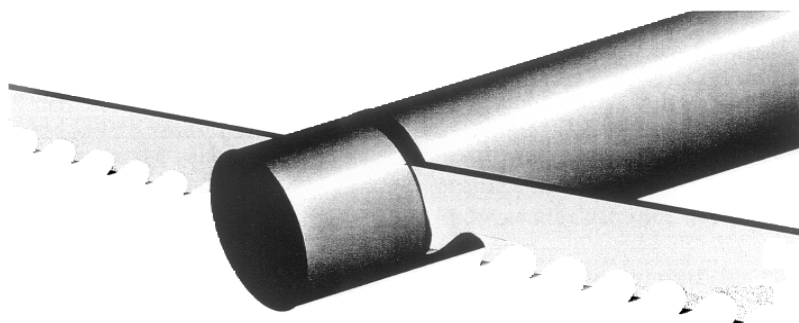

BLADE ANY
DIMENSIONS
AVAILABLE
ON REQUEST

MATÉRIEL À COUPER / MATERIAL TO BE CUT : _____

DURETÉ / HARDNESS : _____

LA FORME DU PRODUIT À COUPER / THE SHAPE OF PRODUCT YOU ARE CUTTING



LONGUEUR DE LA LAME / BLADE LENGTH : _____

DENTS PAR POUCE /

LARGEUR DE LA LAME / BLADE WIDTH : _____

TEETH PER INCH (TPI) :

ÉPAISSEUR DE LA LAME / BLADE THICKNESS : _____

COUPE MÉTAL

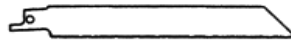

METAL CUTTING

NOTRE CODE	DESCRIPTION	DENTS PAR POUCE
OUR CODE	DESCRIPTION	TEETH PER INCH
OU004010	4 X 3/4 X .035	10
*****	4 X 3/4 X .035	14
OU004018	4 X 3/4 X .035	18
*****	4 X 3/4 X .035	24

NOTRE CODE	DESCRIPTION	DENTS PAR POUCE
OUR CODE	DESCRIPTION	TEETH PER INCH
*****	6 X 3/4 X .035	10
OU600010	6 X 3/4 X .035	14
OU600017	6 X 3/4 X .035	18
OU600012	6 X 3/4 X .035	24

MÉTAL CONTOUR

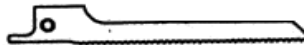

METAL SCROLL

NOTRE CODE	DESCRIPTION	DENTS PAR POUCE
OUR CODE	DESCRIPTION	TEETH PER INCH
*****	3 1/2 X 5/16 X .035	14
*****	4 1/2 X 5/16 X .035	18

COUPE PLÂTRE

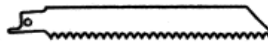

PLASTER CUTTING

NOTRE CODE	DESCRIPTION	DENTS PAR POUCE
OUR CODE	DESCRIPTION	TEETH PER INCH
*****	6 X 3/4 X .050	6

MÉTAL



METAL

NOTRE CODE	DESCRIPTION	DENTS PAR POUCE
OUR CODE	DESCRIPTION	TEETH PER INCH
*****	8 X 3/4 X .035	10/14
OU800018	8 X 3/4 X .035	18



CONTOUR BOIS

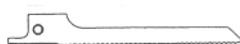

WOOD CONTOUR

NOTRE CODE	DESCRIPTION	DENTS PAR POUCE
OUR CODE	DESCRIPTION	TEETH PER INCH
*****	6 X 7/16 X .050	6

COUPE BOIS



WOOD CUTTING

NOTRE CODE	DESCRIPTION	DENTS PAR POUCE
OUR CODE	DESCRIPTION	TEETH PER INCH
OU600006	6 X 3/4 X .050	6
OU600009	6 X 3/4 X .050	10
*****	6 X 3/4 X .050	5/7

NOTRE CODE	DESCRIPTION	DENTS PAR POUCE
OUR CODE	DESCRIPTION	TEETH PER INCH
OU900013	9 X 3/4 X .050	6

NOTRE CODE	DESCRIPTION	DENTS PAR POUCE
OUR CODE	DESCRIPTION	TEETH PER INCH
*****	12 X 3/4 X .050	6
*****	12 X 3/4 X .050	2/3
OU121014	12 X 3/4 X .050	10/14





LAME BI-METAL BLADES

NOTRE CODE	LONGUEUR	DENTS	UTILISATION
OUR CODE	LENGTH	TPI	RECOMMENDED USE
OU003013	3	14	POUR MÉTAL 1/8 ET PLUS HEAVY GAUGE METAL (1/8 THICKER)
OU003018	3	18	POUR MÉTAL GA 18 À 1/8 METAL (18 GAUGE TO 1/8 THICK)
OU003024	3	24	POUR MÉTAL GA 18 ET MOINS METAL (18 GAUGE AND UNDER)
OU003032	3	32	POUR MÉTAL EN FEUILLE MINCE SHEET METAL, TRIM AND OTHER THIN METALS
OU003014	3	14	COUPE DE FINITION MÉTAL-BOIS-FIBRE DE VERRE 1/8 ET + FINISH CUTS IN METAL, WOOD, FIBERGLASS (1/8 AND THICKER)
OU003019	3	18	COUPE DE FINITION MÉTAL-BOIS-FIBRE DE VERRE 18 À 1/8 FINISH CUTS IN METAL, WOOD, FIBERGLASS (1/8 TO 1/8)
OU003020	3	18	COUPE DE FINITION, ACIER INOX. MÉTAL-BOIS-FIBRE DE VERRE METAL INCLUDING STAINLESS STEEL, WOOD, FIBERGLASS

LAME DE CARBONE / CARBON BLADES

NOTRE CODE	LONGUEUR	DENTS	UTILISATION
OUR CODE	LENGTH	TPI	RECOMMENDED USE
OU003506	3 1/2	6	COUPE RAPIDE BOIS- PLÂTRE- CONTRE PLAQUÉ - GYPSE FAST CUTTING IN WOOD, PLASTER, PARTICLE, BOARD, DRYWALL
OU003510	3 1/2	10	COUPE DOUCE BOIS- PLÂTRE -CONTRE PLAQUÉ- GYPSE SMOOTHER CUTS IN WOOD, PLATER, PARTICLE BOARD, DRYWALL
*****	4	6	COUPE ÉGALE BOIS- PLÂTRE- CONTRE PLAQUÉ-GYPSE FLUSH CUTS IN WOOD, PLASTER, PARTICLE BOARD, DRYWALL
*****	2 1/2	14	FORMES IRRÉGULIÈRES ET CONTOURS BOIS IRREGULAR SHAPES AND CONTOURS IN WOOD
*****	3 1/2	10	FORMES IRRÉGULIÈRES ET CONTOURS BOIS IRREGULAR SHAPES AND CONTOURS IN WOOD
*****	3 1/2	10	CONTOURS CREUX DE FINITION HOLLOW GROUND FOR FINISH SCROLL CUTS



EMPORTE-PIÈCES HOLESAW
BI-MÉTAL

NOTRE CODE	DESCRIPTION
OUR CODE	DESCRIPTION
HS300625	5/8
HS300687	11/16
HS300750	3/4
HS300875	7/8
HS300937	15/16
HS301000	1
HS301062	1 1/16
HS301125	1 1/8
HS301187	1 3/16
HS301250	1 1/4
HS301315	1 5/16
HS301375	1 3/8
HS301437	1 7/16
HS301500	1 1/2
HS301625	1 5/8
HS301750	1 3/4
HS301875	1 7/8
HS302000	2
HS302062	2 1/16
HS302125	2 1/8
HS302250	2 1/4
HS302315	2 5/16
HS302375	2 3/8
HS302500	2 1/2
HS302625	2 5/8
HS302750	2 3/4
HS302875	2 7/8
HS303000	3
HS303125	3 1/8
HS303250	3 1/4
HS303500	3 1/2
HS304000	4
HS304125	4 1/8
HS304500	4 1/2
HS304750	4 3/4
HS305000	5
HS305500	5 1/2
HS306000	6

Aggressor®

BLU-MOL®

MANDRINS

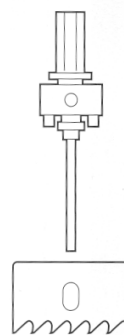

MANDRELS

NOTRE CODE	DESCRIPTION	POUR EMP PCES
OUR CODE	DESCRIPTION	FIT HOLE SAW
AH000250	1/4	9/16 À 1 3/16
AH000315	5/8	1 1/4 À 6
AH000437	7/16	9/16 À 1 3/16
AH001437	7/16	1 1/4 À 6
AH002436	3/8	9/16 À 1 3/16
AH002437	3/8	1 1/4 À 6

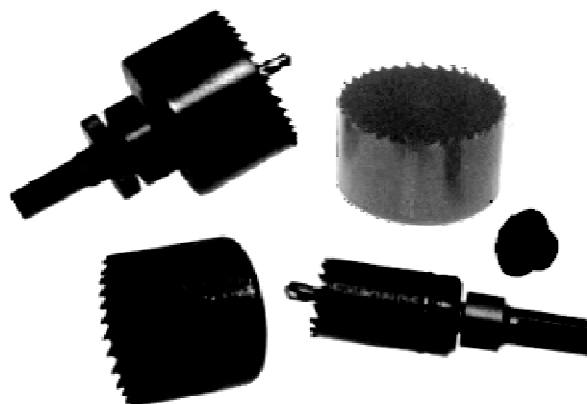

MÈCHES POUR
EMPORTE-PIÈCES

HOLESAW
DRILLS

NOTRE CODE	DESCRIPTION
OUR CODE	DESCRIPTION
MF880012	1/4 X 3 1/4
MF880013	1/4 X 4 1/4



MARQUE / BRAND: "BLU-MOL"

NOTRE CODE	NOM DE L'ENSEMBLE	DESCRIPTION
OUR CODE	KIT NAME	DESCRIPTION
HS200001	ELECTRICIEN CONTIENT:	6 EMPORTE-PIÈCES: 7/8" - 1 1/8" - 1 3/8" - 1 3/4" - 2" - 2 1/2" 1 MANDRIN NO 5515 & 5546 1 ADAPTEUR POUR MANDRIN NO 5511
"BLU-MOL"		
KIT	ELECTRICIAN INCLUDE:	6 HOLE SAWS: 7/8" - 1 1/8" - 1 3/8" - 1 3/4" - 2" - 2 1/2" 1 MANDREL NO 5515 & 5546 1 MANDREL ADAPTER NO 5511
HS200002	PLOMBIER CONTIENT:	6 EMPORTE-PIÈCES: 3/4" - 7/8" - 1 1/8" - 1 1/2" - 1 3/4" - 2 1/4"
"BLU-MOL"		1 MANDRIN NO 5515 & 5546 1 ADAPTEUR POUR MANDRIN NO 5511
KIT	PLOMBER'S INCLUDE:	6 HOLE SAWS: 3/4" - 7/8" - 1 1/8" - 1 1/2" - 1 3/4" - 2 1/4" 1 MANDREL NO 5515 & 5546 1 MANDREL ADAPTER NO 5511
HS200003	JOURNALIER CONTIENT:	9 EMPORTE-PIÈCES: 3/4" - 7/8" - 1 3/8" - 1 1/2" - 1 3/4" - 2" - 2 1/4" - 2 1/2"
"BLU-MOL"		1 MANDRIN NO 5515 & 5546 1 ADAPTEUR POUR MANDRIN NO 5511
KIT	JOURNEYMAN'S INCLUDE:	9 HOLE SAWS: 3/4" - 7/8" - 1 3/8" - 1 1/2" - 1 3/4" - 2" - 2 1/4" - 2 1/2" 1 MANDREL NO 5515 & 5546 1 MANDREL ADAPTER NO 5511

N° MANDRIN	POUR EMPORTE-PIÈCES	POUR MANDRIN
ARBUR N°	FITS HOLE SAWS	FITS CHUCK SIZES:
5515	9/16" - 1 3/16"	1/4" - 1/2"
5546	1 1/4" - 6"	3/8" - 1/2"

N° MANDRIN	DIA. TIGE
ARBUR N°	SHANK SIZE:
5515	1/4 UNIVERSAL
5546	3/8 HEX QUICK CHANGE

BLU-MOL®



Tel.: (819) 346-2903 / (888) 345-2903 Fax.: (819) 346-3389

Email: distributeur@boulonsestrie.com



MARQUE / BRAND: "AGRESSOR"

NOTRE CODE	NOM DE L'ENSEMBLE	DESCRIPTION
OUR CODE	KIT NAME	DESCRIPTION
HS200004 "AGRESSOR"	ELECTRICIEN CONTIENT:	6 EMPORTE-PIÈCES: 7/8" - 1 1/8" - 1 1/2" - 1 3/4" - 2" - 2 1/2" 1 MANDRIN NO 5515 & 5546 1 ADAPTEUR POUR MANDRIN NO 5511
KIT	ELECTRICIAN INCLUDE:	6 HOLE SAWS: 7/8" - 1 1/8" - 1 3/8" - 1 3/4" - 2" - 2 1/2" 1 MANDREL NO 5515 & 5546 1 MANDREL ADAPTER NO 5511
HS200005 "AGRESSOR"	PLOMBIER CONTIENT:	6 EMPORTE-PIÈCES: 3/4" - 7/8" - 1 1/8" - 1 1/2" - 1 3/4" - 2 1/4" 1 MANDRIN NO 5515 & 5546 1 ADAPTEUR POUR MANDRIN NO 5511
KIT	PLOMBER'S INCLUDE:	6 HOLE SAWS: 3/4" - 7/8" - 1 1/8" - 1 1/2" - 1 3/4" - 2 1/4" 1 MANDREL NO 5515 & 5546 1 MANDREL ADAPTER NO 5511
HS200006 "AGRESSOR"	QUALITÉ CONTIENT:	9 EMPORTE-PIÈCES: 3/4" - 7/8" - 1 1/8" - 1 3/8" - 1 1/2" - 1 3/4" - 2" - 2 1/4" 1 MANDRIN NO 5515 & 5546 1 ADAPTEUR POUR MANDRIN NO 5511 1 MÈCHE POUR EMPORTE-PIÈCE : 1/4 X 3 1/4"
KIT	DELUXE INCLUDE:	9 HOLE SAWS: 3/4" - 7/8" - 1 1/8" - 1 3/8" - 1 1/2" - 1 3/4" - 2" - 2 1/4" 1 MANDREL NO 5515 & 5546 1 MANDREL ADAPTER NO 5511 1 PILOT DRILLS : 1/4 X 3 1/4"

N° MANDRIN	POUR EMPORTE-PIÈCES	POUR MANDRIN
ARBUR N°	FITS HOLE SAWS	FITS CHUCK SIZES:
5515	9/16" - 1 3/16"	1/4" - 1/2"
5546	1 1/4" - 6"	3/8" - 1/2"

N° MANDRIN	DIA. TIGE
ARBUR N°	SHANK SIZE:
5515	1/4 UNIVERSAL
5546	3/8 HEX QUICK CHANGE

Aggressor®

LAME AU CARBURE - DÉMOLITION POUR LE BOIS - AMIANTE-LAMINÉ
CARBIDE TIPPED BLADE FOR SAWING OF WOOD-LAMINATES- ASBESTOS



USAGE GÉNÉRAL / GENERAL PURPOSE

NOTRE CODE	DIAMÈTRE	DIA DU NOYAU	◆	DENTS PAR POUCE
OUR CODE	DIAMETER	BORE INCHES	◆	TEETH PER INCH
*****	6 1/2	5/8	13/16	16
*****	7 1/4	5/8	13/16	18
*****	7 1/4	5/8	13/16	24
QL071991	7 1/4	5/8	13/16	24
*****	8	5/8	13/16	20
*****	8 1/4	5/8	13/16	24

LAME AU CARBURE -USAGE GÉNÉRAL-FINITION POUR BOIS DUR ET MOU
CARBIDE TIPPED BLADE FOR CUTTING IN BOTH HARD AND SOFT WOODS



USAGE GÉNÉRAL / GENERAL PURPOSE

NOTRE CODE	DIAMÈTRE	DIA DU NOYAU	◆	DENTS PAR POUCE
OUR CODE	DIAMETER	BORE INCHES	◆	TEETH PER INCH
*****	6 1/2	5/8	13/16	40
*****	7 1/4	5/8	13/16	40
*****	8	5/8	13/16	40
*****	8 1/4	5/8	13/16	40
*****	10	5/8		28
*****	10	5/8		40
QL071992	10	5/8		60

TITANIUM

Carbide Teeth







NOTRE CODE	DIAMÈTRE	DENTS
OUR CODE	DIAMETER	TEETH
QL067012	7 1/4	24



SECTION M

ABRASIFS / ABRASIVES

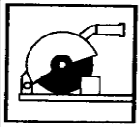
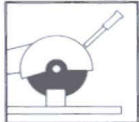
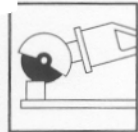
INFORMATION TECHNIQUE.....DÉBUT DE LA SECTION
TECHNICAL INFORMATION.....BEGINNING OF THIS SECTION

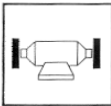
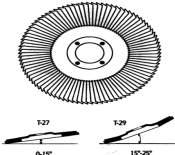
	DESCRIPTION	SECTION-PAGE
	MEULES À ÉBARBER À <i>CENTRE INCURVÉ</i>. DEPRESSED CENTER GRINDING WHEELS.	M-1
	MEULES À <i>CENTRE INCURVÉ</i> TRONÇONNAGE ET ÉBARBAGE LÉGER. DEPRESSED CENTER CUT-OFF AND LIGHT GRINDING WHEELS.	M-2
	MEULES À <i>CENTRE INCURVÉ</i> POUR TRONÇONNAGE. DEPRESSED CENTER CUT-OFF WHEELS.	M-3
	MEULES À TRONÇONNER POUR MEULEUSE À ANGLE. CUT-OFF WHEELS FOR ANGLE GRINDER.	M-4
	MEULES À TRONÇONNER POUR SCIE FENDEUSE PORTATIVE. CUT-OFF WHEELS FOR PORTABLE CHOP-SAW.	M-5
	MEULES À TRONÇONNER POUR MACHINE STATIONNAIRE. CUT-OFF WHEELS FOR STATIONARY MACHINE.	M-6
	MEULES À TRONÇONNER POUR SCIE PORTATIVE À HAUTE VITESSE . CUT-OFF WHEELS FOR PORTABLE HIGH SPEED POWER SAW.	M-7
	REDRESSEUR DE MEULES. WHEELS REDRESSER.	M-7
	MEULES À RECTIFIER POUR MEULEUSE D'ÉTABLI ET SUR PIED. BENCH AND PEDESTAL GRINDING WHEELS.	M-8
	DISQUES À LAMELLE "POLY-FLAP". POLY-FLAP DISCS.	M-8

SECTION M

ABRASIFS / ABRASIVES



**ROUES À FEUILLETS ABRASIFS SUR TIGE.
MOUNTED FLAP WHEELS.**

SECTION-PAGE

M-9



**DISQUES À SABLER AUTOCOLLANTS.
ADHESIVE CLOTH DISCS.**

**SUR DEMANDE
ON REQUEST**

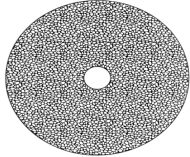

**DISQUES À PONCER .
RESIN FIBER DISCS.**

**SUR DEMANDE
ON REQUEST**



**PAPIERS SABLÉS OXYDE D'ALUMINIUM.
COATED ABRASIVE SHEET ALUMINUM OXYDE.**

M-10



**ROULEAUX PRATIQUES.
HANDY ROLS.**

M-10



**COURROIES À SABLER, USAGE GÉNÉRAL.
ALUMINUM OXYDE, OPEN COAT ABRASIVE BELTS.**

M-11



**BROSSES D'ACIER.
WIRE BRUSHES.**

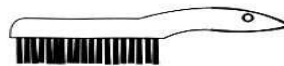

M-12



Tel.: (819) 346-2903 / (888) 345-2903 Fax.: (819) 346-3389

Email: distributeur@boulonsestrie.com

MEULES / WHEELS

TYPE 1



TYPE 27



TYPE 28



MEULES MONTÉES SUR TIGE / MOUNTED WHEELS



TYPE A

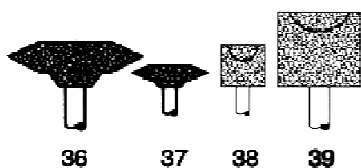
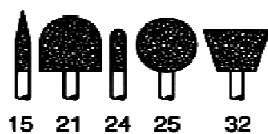
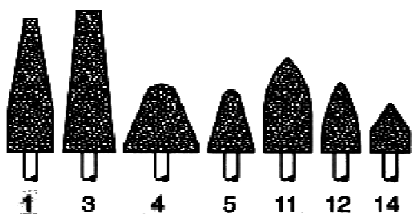

TYPE B

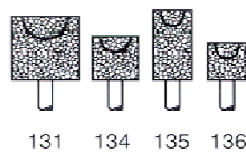
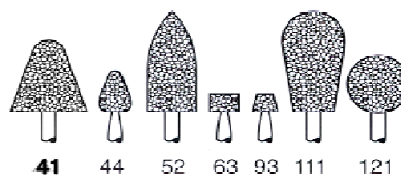

MEULES BOISSEAUX / CUP WHEELS



TYPE W



INFO TECHIQUE M (T-1)

BROSSES MÉTALLIQUES / WIRE BRUSHES

**BROSSES SUR TIGE ACIER AU CARBONE TIGE 1/4" /
WIRE END BRUSHES CARBON STEEL 1/4"**

TYPE A TYPE B TYPE C TYPE D

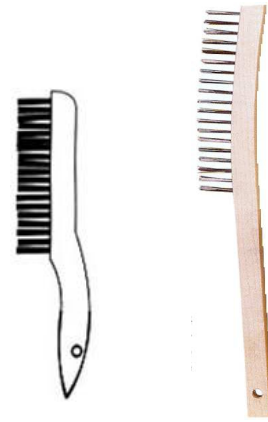
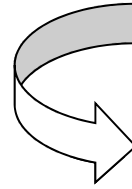

VOIR PAGE M-12

BROSSES CIRCULAIRES & BOISSEAUX / CIRCULAR & CUP BRUSHES

> À FILS NOUÉS AU CARBONE & ACIER INOX + POUR PIPELINES > POUR MEULEUSE D'ÉTABLIE
> KNOT WIRE CARBON STEEL & STAINLESS + FOR PIPELINE > FOR BENCH GRINDER

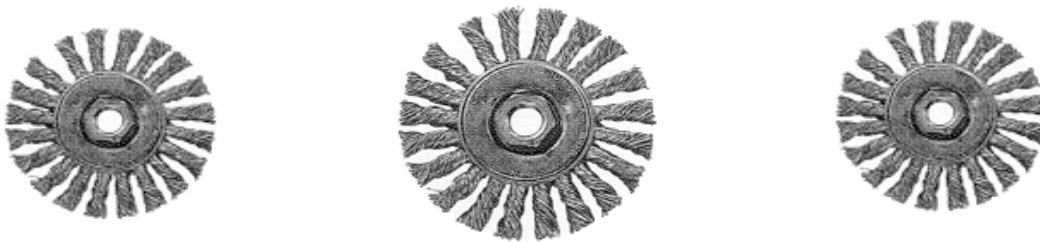

> À FILS CRÊPÉS ACIER AU CARBONE
> CRIMPED WIRE CARBON STEEL

> À FILS NOUÉS CARBONE & ACIER INOX
> KNOT WIRE CARBON & STAINLESS STEEL

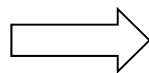

VOIR PAGE M-12

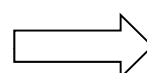

VOIR PAGE M-12

> À FILS NOUÉS ACIER AU CARBONE & ACIER INOX.
> KNOT WIRE CARBON & STAINLESS STEEL

> À FILS CRÊPÉS (MEULEUSE ETABLIE)
> CRIMPED WIRE (BENCH GRINDER)

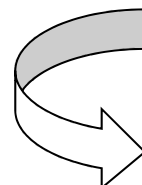
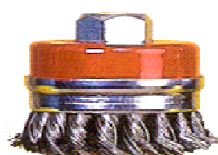

**VOIR
PAGE
M-12**



INFO TECHNIQUE M (T-2)

FRAISES AU CARBURE / CARBIDE BURRS



CYLINDRIQUE
CYLINDRIQUE
À TÊTE COUPANTE
CYLINDRIQUE
À TÊTE ARRONDIE
SPHÉRIQUE
OVALE
ARBRE
À TÊTE ARRONDIE
ARBRE
À TÊTE POINTUE
FLAMME
ANGLE
CÔNE
À TÊTE POINTUE
CÔNE
INVERSÉ

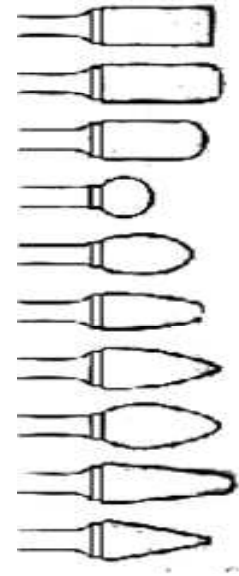

PAPIER SABLÉ & BANNIÈRES / SAND PAPER

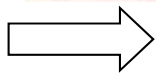

VOIR PAGE M-10

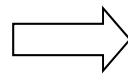

VOIR PAGE M-11



AUTRES / OTHER ...

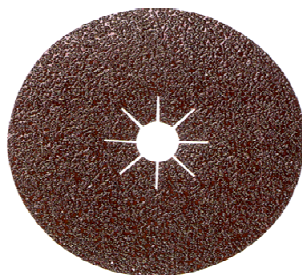

**MEULES À ÉBARBER À CENTRE INCURVÉ
DEPRESSED CENTER GRINDING WHEELS**

A24N 1/4" (MÉTAL)

(USAGE GÉNÉRAL, ÉBARBAGE RAPIDE) / (GENERAL PURPOSE, FAST GRINDING)

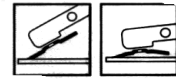

TYPE 27

NOTRE CODE	DESCRIPTION	QTÉ/BTE
OUR CODE	DESCRIPTION	QTY/BOX
*****	4 1/2" X 1/4" X 5/8"	25
GW502588	5" X 1/4 X 7/8"	25
*****	6" X 1/4" X 7/8"	25
GW702586	7" X 1/4" X 7/8"	25

A24R 1/4" (MÉTAL)

(USAGE GÉNÉRAL, LONGUE DURÉE) / (GENERAL PURPOSE, LONG LIFE)

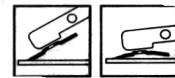

TYPE 27

NOTRE CODE	DESCRIPTION	QTÉ/BTE
OUR CODE	DESCRIPTION	QTY/BOX
GW401288	4" X 1/4" X 5/8"	25
GW452587	4 1/2" X 1/4" X 7/8"	25
GW502587	5" X 1/4 X 7/8"	25
GW602587	6" X 1/4" X 7/8"	25
GW702587	7" X 1/4" X 7/8"	25

SUPRA 1/4" (METAL)

(USAGE GÉNÉRAL, LONGÉTIVITÉ ACCRUE) / (GENERAL PURPOSE, LONGER LIFE)



TYPE 27

NOTRE CODE	DESCRIPTION	QTÉ/BTE
OUR CODE	DESCRIPTION	QTY/BOX
*****	4 1/2" X 1/4" X 7/8"	25
D547V	5" X 1/4" X 7/8"	25
GW702585	7" X 1/4" X 7/8"	25



ALU 24 (ALUMINIUM)

(ÉBARBAGE RAPIDE, ANTI-EMPÂTEMENT) / (FAST GRINDING, CLOG RESISTANT)

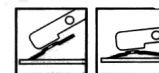

TYPE 27

NOTRE CODE	DESCRIPTION	QTÉ/BTE
OUR CODE	DESCRIPTION	QTY/BOX
GWA45287	4 1/2 X 1/4 X 5/8	25
GW702588	5 X 1/4 X 7/8	25
*****	7 X 1/4 X 7/8	25

C 24 R (BÉTON)

(USAGE GÉNÉRAL, LONGUE DURÉE) / (GENERAL PURPOSE, LONG LIFE)

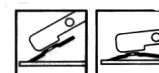

TYPE 27

NOTRE CODE	DESCRIPTION	QTÉ/BTE
OUR CODE	DESCRIPTION	QTY/BOX
GWC42562	4 X 1/4 X 5/8	25
*****	4 1/2 X 1/4 X 7/8	25
*****	5 X 1/4 X 7/8	25
*****	6 X 1/4 X 7/8	25
*****	7 X 1/4 X 7/8	25

MEULES À CENTRE INCURVÉ (TRONÇONNAGE ET ÉBARBAGE LÉGER)

DEPRESSED CENTER CUT-OFF AND LIGHT GRINDING WHEELS

A 24 R (MÉTAL)

(USAGE GÉNÉRAL, LONGUE DURÉE) / (GENERAL PURPOSE, LONG LIFE)

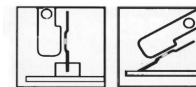

TYPE 27

NOTRE CODE	DESCRIPTION	QTÉ/BTE
OUR CODE	DESCRIPTION	QTY/BOX
GW451286	4 1/2" X 5/32" X 7/8"	25
GW509385	5" X 1/8" X 7/8"	25
*****	7" X 5/32" X 7/8"	25



**MEULES À CENTRE INCURVÉ POUR TRONÇONNAGE
DEPRESSED CENTER CUT-OFF WHEELS**

A24R (MÉTAL)

(USAGE GÉNÉRAL, LONGUE DURÉE) / (GENERAL PURPOSE, LONG LIFE)



TYPE 27

NOTRE CODE	DESCRIPTION	QTÉ/BTE
OUR CODE	DESCRIPTION	QTY/BOX
GW036238	3 X 1/8 X 3/8	25
GW401287	4 X 1/8 X 5/8	25
GW451285	4 1/2 X 3/32 X 7/8	25
GW451287	4 1/2 X 1/8 X 7/8	25
GW509386	5 X 3/32 X 7/8	25
GW501287	5 X 1/8 X 7/8	25
*****	6 X 1/8 X 7/8	25
GW700587	7 X 3/32 X 7/8	25
GW701287	7 X 1/8 X 7/8	25

PRECICUT (ACIER INOXYDABLE ET MÉTAL)

(DURÉE EXTRA LONGUE , COUPE RAPIDE SANS SURCHAUFFE) / (EXTRA LONG LIFE, FAST AND COOL CUTTING)



TYPE 27

NOTRE CODE	DESCRIPTION	QTÉ/BTE
OUR CODE	DESCRIPTION	QTY/BOX
GW044562	4" X .050" X 5/8"	50
GW054565	4 1/2" X .050" X 7/8"	50
GW066005	5" X .050" X 7/8"	50
*****	6" X .050" X 7/8"	50
GW066007	7" X .060" X 7/8"	50

AA30R (ACIER INOXIDABLE ET MÉTAL)

(COUPE RAPIDE SANS SURCHAUFFE) / (FAST AND COOL CUTTING)



TYPE 27

NOTRE CODE	DESCRIPTION	QTÉ/BTE
OUR CODE	DESCRIPTION	QTY/BOX
*****	4 1/2 X 3/32 X 7/8	25
GW509388	5 X 3/32 X 7/8	25
GW709387	7 X 3/32 X 7/8	25

**MEULES À TRONÇONNER POUR MEULEUSE À ANGLE
CUT-OFF WHEELS FOR ANGLE GRINDER**

PRECICUT (ACIER INOXYDABLE ET MÉTAL)

(DURÉE EXTRA LONGUE ,COUPE RAPIDE SANS SURCHAUFFE) / (LONG LIFE FAST AND COOL CUTTING)



TYPE 1

NOTRE CODE	DESCRIPTION	QTÉ/BTE
OUR CODE	DESCRIPTION	QTY/BOX
*****	4"X .050 X 5/8"	50
GW054566	4 1/2" X .050 X 7/8"	50
GW054587	5" X .050 X 7/8"	50
GW064087	6" X 0.50" X 7/8"	50
*****	7" X 0.50" X 7/8"	50

A24R (MÉTAL)

(USAGE GÉNÉRAL, LONGUE DURÉE) / (GENERAL PURPOSE, LONG LIFE)



TYPE 1

NOTRE CODE	DESCRIPTION	QTÉ/BTE
OUR CODE	DESCRIPTION	QTY/BOX
*****	4 1/2 X 3/32 X 5/8	25
GW509387	5 X 3/32 X 7/8	25
GW609387	6 X 3/32 X 7/8	25
*****	7 X 3/32 X 7/8	25
GW909387	9 X 3/32 X 7/8	25

AA30R (ACIER INOXYDABLE ET MÉTAL)

(COUPE RAPIDE SANS SURCHAUFFE) / (FAST AND COOL CUTTING)



TYPE 1

NOTRE CODE	DESCRIPTION	QTÉ/BTE
OUR CODE	DESCRIPTION	QTY/BOX
*****	4 1/2 X 1/16 X 5/8	25
*****	5 X 1/16 X 7/8	25
GW709386	7 X 1/16 X 7/8	25

**MEULES À TRONÇONNER POUR SCIE FENDEUSE PORTATIVE
CUT-OFF WHEELS FOR PORTABLE CHOP-SAW**

A30N(MÉTAL)

(USAGE GÉNÉRAL , COUPE RAPIDE) / GENERAL PURPOSE, FAST CUTTING)



TYPE 1

NOTRE CODE	DESCRIPTION	QTÉ/BTE
OUR CODE	DESCRIPTION	QTY/BOX
GW120911	12 X 3/32 X 1	10
GW140909	14 X 3/32 X 1	10
*****	16 X 1/8 X 1	10

A30R (MÉTAL)

(USAGE GÉNÉRAL LONGUE DURÉE) / (GENERAL PURPOSE, LONG LIFE)



TYPE 1

NOTRE CODE	DESCRIPTION	QTÉ/BTE
OUR CODE	DESCRIPTION	QTY/BOX
GW120910	12 X 3/32 X 1	10
GW140910	14 X 3/32 X 1	10
*****	16 X 1/8 X 1	10

AA30R (ACIER INOXYDABLE ET MÉTAL)

(COUPE RAPIDE SANS SURCHAUFFE) / (COOL AND FAST CUTTING)



TYPE 1

NOTRE CODE	DESCRIPTION	QTÉ/BTE
OUR CODE	DESCRIPTION	QTY/BOX
*****	12 X 3/32 X 1	10
GW140911	14 X 3/32 X 1	10
*****	16 X 1/8 X 1	10



Tel.: (819) 346-2903 / (888) 345-2903 Fax.: (819) 346-3389

Email: distributeur@boulonsestrie.com

M-5

**MEULES À TRONÇONNER POUR MACHINE STATIONNAIRE
CUT-OFF WHEELS FOR STATIONARY MACHINE**

A30N (MÉTAL)

(USAGE GÉNÉRAL, COUPE RAPIDE) / (GENERAL PURPOSE, FAST CUTTING)



NOTRE CODE	DESCRIPTION	QTÉ/BTE
OUR CODE	DESCRIPTION	QTY/BOX
GW121209	12" X 1/8" X 1"	10
*****	14" X 5/32" X 1"	10
*****	16" X 5/32" X 1"	10

A30R (MÉTAL)

(USAGE GÉNÉRAL, LONGUE DURÉE) / (GENERAL PURPOSE, LONG LIFE)

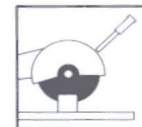

NOTRE CODE	DESCRIPTION	QTÉ/BTE
OUR CODE	DESCRIPTION	QTY/BOX
GW121210	12" X 1/8" X 1"	10
*****	14" X 5/32" X 1"	10
*****	16" X 5/32" X 1"	10
GW201278	20" X 3/16" X 1"	10



Tel.: (819) 346-2903 / (888) 345-2903 Fax.: (819) 346-3389
Email: distributeur@boulonstrie.com

**MEULES À TRONÇONNER POUR SCIE PORTATIVE À HAUTE VITESSE
CUT-OFF WHEELS FOR PORTABLE HIGH SPEED POWER SAW**

A24R (MÉTAL)

(USAGE GÉNÉRAL ,LONGUE DURÉE) / (GENERAL PURPOSE, LONG LIFE)



TYPE 1

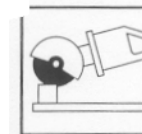

NOTRE CODE	DESCRIPTION	QTÉ/BTE
OUR CODE	DESCRIPTION	QTY/BOX
*****	14 X 1/8 X 20 mm	10
GW141209	14 X 1/8 X 7/8	10
GW141210	14 X 1/8 X 1	10

C24R(BÉTON)

(USAGE GÉNÉRAL, LONGUE DURÉE) / (GENERAL PURPOSE, LONG LIFE)



TYPE 1

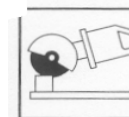

NOTRE CODE	DESCRIPTION	QTÉ/BTE
OUR CODE	DESCRIPTION	QTY/BOX
GW141220	14 X 1/8 X 20 mm	10
GW141211	14 X 1/8 X 1	10

REDRESSEURS DE MEULES

REDRESSER WHEELS

NOTRE CODE	MODÈLE	TAILLE DE LA MEULE À REDRESSER
OUR CODE	MODEL	FOR WHAT WHEEL DIAMETER
*****	NO 0	JUSQU'À / UP TO 10" DIAMETER
*****	NO 1	DE / FROM 10" À / UP TO 16" DIAMETER
*****	NO 2	DE / FROM 16" À / UP TO 36" DIAMETER

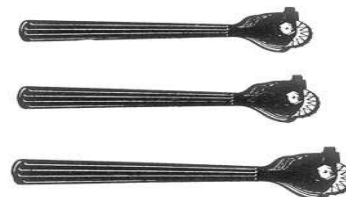

AUSSI DISPONIBLE / ALSO AVAILABLE
MOLETTE DE RECHANGE / WHEEL ONLY

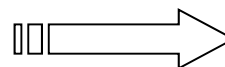

Tel.: (819) 346-2903 / (888) 345-2903 Fax.: (819) 346-3389
Email: distributeur@boulonnestrie.com

M-7

MEULES / WHEELS

TYPE 1



TYPE 27



TYPE 28



MEULES MONTÉES SUR TIGE / MOUNTED WHEELS



TYPE A

TYPE B

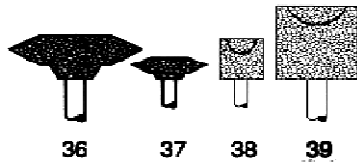
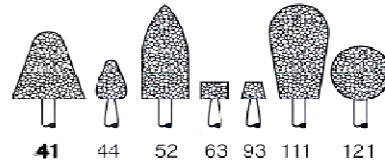
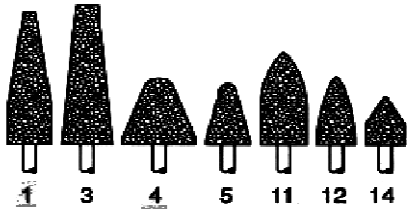

TYPE

MEULES BOISSEAUX / CUP WHEELS



BROSSES MÉTALLIQUES / WIRE BRUSHES

M (T-1)

**BROSSES SUR TIGE ACIER AU CARBONE TIGE 1/4" /
WIRE END BRUSHES CARBON STEEL 1/4"**

TYPE A TYPE B TYPE C TYPE D

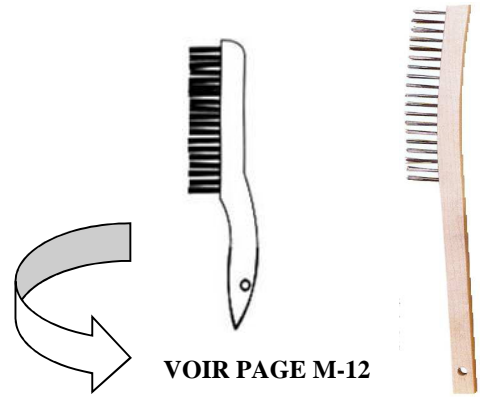

BROSSES CIRCULAIRES & BOISSEAUX / CIRCULAR & CUP BRUSHES

> À FILS NOUÉS AU CARBONE & ACIER INOX + POUR PIPELINES
> KNOT WIRE CARBON STEEL & STAINLESS + FOR PIPELINE

> POUR MELEUSE D'ÉTABLIE
> FOR BENCH GRINDERS

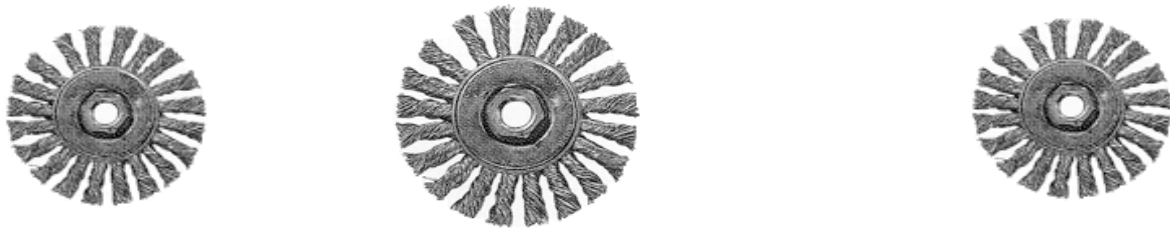

> À FILS CRÊPÉS ACIER AU CARBONE
> CRIMPED WIRE CARBON STEEL

> À FILS NOUÉS CARBONE & ACIER INOX
> KNOT WIRE CARBON & STAINLESS STEEL



➔ VOIR PAGE M-12

➔ VOIR PAGE M-12

> À FILS NOUÉS ACIER AU CARBONE & ACIER INOXYDABLE
> KNOT WIRE CARBON & STAINLESS STEEL

> À FILS CRÊPÉS (MELEUSE ETABLIE)
> CRIMPED WIRE (BENCH GRINDERS)

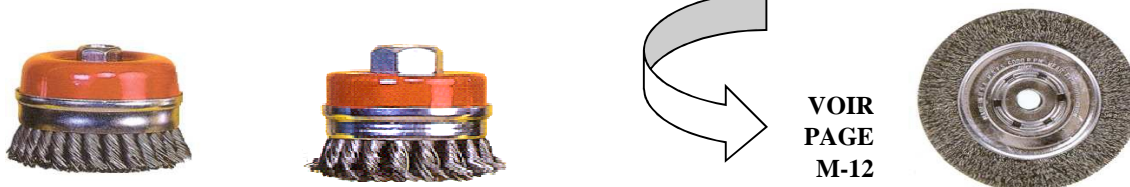

➔ VOIR PAGE M-12

M (T-2)

FRAISES AU CARBURE / CARBIDE BURRS



**CYLINDRIQUE
CYLINDRIQUE**

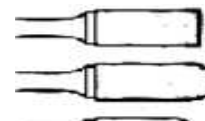



À TÊTE COUPANTE
 CYLINDRIQUE
 À TÊTE ARRONDIE
 SPHÉRIQUE
 OVALE
 ARBRE
 À TÊTE ARRONDIE
 ARBRE
 À TÊTE POINTUE
 FLAMME
 ANGLE
 CÔNE
 À TÊTE POINTUE
 CÔNE
 INVERSÉ

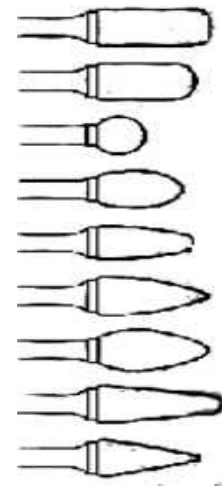

PAPIER SABLÉ & BANNIÈRES / SAND PAPER

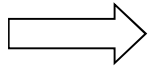

VOIR PAGE M-10

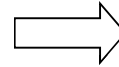

VOIR PAGE M-11

AUTRES / OTHER ...



M (T-3)

**MEULES À ÉBARBER À CENTRE INCURVÉ
DEPRESSED CENTER GRINDING WHEELS**

A24N 1/4" (MÉTAL)

(USAGE GÉNÉRAL, ÉBARBAGE RAPIDE) / (GENERAL PURPOSE, FAST GRINDING)



NOTRE CODE	DESCRIPTION	QTÉ/BTE
OUR CODE	DESCRIPTION	QTY/BOX
*****	4 1/2" X 1/4" X 5/8"	25
GW502588	5" X 1/4 X 7/8"	25
*****	6" X 1/4" X 7/8"	25
GW702586	7" X 1/4" X 7/8"	25

A24R 1/4" (MÉTAL)

(USAGE GÉNÉRAL, LONGUE DURÉE) / (GENERAL PURPOSE, LONG LIFE)

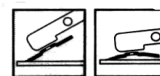

TYPE 27

NOTRE CODE	DESCRIPTION	QTÉ/BTE
OUR CODE	DESCRIPTION	QTY/BOX
GW401288	4" X 1/4" X 5/8"	25
GW452587	4 1/2" X 1/4" X 7/8"	25
GW502587	5" X 1/4 X 7/8"	25
GW602587	6" X 1/4" X 7/8"	25
GW702587	7" X 1/4" X 7/8"	25

SUPRA 1/4" (METAL)

(USAGE GÉNÉRAL, LONGÉVITÉ ACCRUE) / (GENERAL PURPOSE, LONGER LIFE)

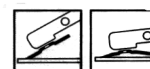

TYPE 27

NOTRE CODE	DESCRIPTION	QTÉ/BTE
OUR CODE	DESCRIPTION	QTY/BOX
*****	4 1/2" X 1/4" X 7/8"	25
D547V	5" X 1/4" X 7/8"	25
GW702585	7" X 1/4" X 7/8"	25



M-1

ALU 24 (ALUMINIUM)

(ÉBARBAGE RAPIDE, ANTI-EMPÂTEMENT) / (FAST GRINDING, CLOG RESISTANT)

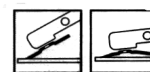

TYPE 27

NOTRE CODE	DESCRIPTION	QTÉ/BTE
OUR CODE	DESCRIPTION	QTY/BOX
GWA45287	4 1/2 X 1/4 X 5/8	25
GW702588	5 X 1/4 X 7/8	25
*****	7 X 1/4 X 7/8	25

C 24 R (BÉTON)

(USAGE GÉNÉRAL, LONGUE DURÉE) / (GENERAL PURPOSE, LONG LIFE)



TYPE 27

NOTRE CODE	DESCRIPTION	QTÉ/BTE
OUR CODE	DESCRIPTION	QTY/BOX
GWC42562	4 X 1/4 X 5/8	25
*****	4 1/2 X 1/4 X 7/8	25
*****	5 X 1/4 X 7/8	25
*****	6 X 1/4 X 7/8	25
*****	7 X 1/4 X 7/8	25

MEULES À CENTRE INCURVÉ (TRONÇONNAGE ET ÉBARBAGE LÉGER) DEPRESSED CENTER CUT-OFF AND LIGHT GRINDING WHEELS

A 24 R (MÉTAL)

(USAGE GÉNÉRAL, LONGUE DURÉE) / (GENERAL PURPOSE, LONG LIFE)

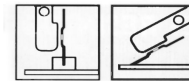

TYPE 27

NOTRE CODE	DESCRIPTION	QTÉ/BTE
OUR CODE	DESCRIPTION	QTY/BOX
GW451286	4 1/2" X 5/32" X 7/8"	25
GW509385	5" X 5/32" X 7/8"	25
*****	7" X 5/32" X 7/8"	25



M-2

MEULES À CENTRE INCURVÉ POUR TRONÇONNAGE DEPRESSED CENTER CUT-OFF WHEELS

A24R (MÉTAL)

(USAGE GÉNÉRAL, LONGUE DURÉE) / (GENERAL PURPOSE, LONG LIFE)



TYPE 27

NOTRE CODE	DESCRIPTION	QTÉ/BTE
OUR CODE	DESCRIPTION	QTY/BOX
GW036238	3 X 1/8 X 3/8	25
GW401287	4 X 1/8 X 5/8	25
GW451285	4 1/2 X 3/32 X 7/8	25

GW451287	4 1/2 X 1/8 X 7/8	25
GW509386	5 X 3/32 X 7/8	25
GW501287	5 X 1/8 X 7/8	25
*****	6 X 1/8 X 7/8	25
GW700587	7 X 3/32 X 7/8	25
GW701287	7 X 1/8 X 7/8	25

PRECICUT (ACIER INOXYDABLE ET MÉTAL)

DURÉE EXTRA LONGUE ,COUPE RAPIDE SANS SURCHAUFFE) / (EXTRA LONG LIFE, FAST AND COOL CUTTING



TYPE 27

NOTRE CODE	DESCRIPTION	QTÉ/BTE
OUR CODE	DESCRIPTION	QTY/BOX
GW044562	4" X .050" X 5/8"	50
GW054565	4 1/2" X .050" X 7/8"	50
GW066005	5" X 0.50" X 7/8"	50
*****	6" X 0.50" X 7/8"	50
GW066007	7" X 0.50" X 7/8"	50

AA30R(ACIER INOXIDABLE ET MÉTAL)

(COUPE RAPIDE SANS SURCHAUFFE) / (FAST AND COOL CUTTING)



TYPE 27

NOTRE CODE	DESCRIPTION	QTÉ/BTE
OUR CODE	DESCRIPTION	QTY/BOX
*****	4 1/2 X 3/32 X 7/8	25
GW509388	5 X 3/32 X 7/8	25
GW709387	7 X 3/32 X 7/8	25

M-3

MEULES À TRONÇONNER POUR MEULEUSE À ANGLE CUT-OFF WHEELS FOR ANGLE GRINDER

PRECICUT (ACIER INOXIDABLE ET MÉTAL)

(DURÉE EXTRA LONGUE ,COUPE RAPIDE SANS SURCHAUFFE) / (LONG LIFE FAST AND COOL CUTTING)



TYPE 1

NOTRE CODE	DESCRIPTION	QTÉ/BTE
OUR CODE	DESCRIPTION	QTY/BOX
*****	4"X .050 X 5/8"	50
GW054566	4 1/2" X .050 X 7/8"	50
GW054587	5" X .050 X 7/8"	50
GW064087	6" X 0.50" X 7/8"	50

7" X 0.50" X 7/8"

50

A24R (MÉTAL)**(USAGE GÉNÉRAL, LONGUE DURÉE) / GENERAL PURPOSE, LONG LIFE)****TYPE 1**

NOTRE CODE	DESCRIPTION	QTÉ/BTE
OUR CODE	DESCRIPTION	QTY/BOX
*****	4 1/2 X 3/32 X 5/8	25
GW509387	5 X 3/32 X 7/8	25
GW609387	6 X 3/32 X 7/8	25
*****	7 X 3/32 X 7/8	25
GW909387	9 X 3/32 X 7/8	25

AA30R (ACIER INOXYDABLE ET MÉTAL)**(COUPE RAPIDE SANS SURCHAUFFE) / (FAST AND COOL CUTTING)****TYPE 1**

NOTRE CODE	DESCRIPTION	QTÉ/BTE
OUR CODE	DESCRIPTION	QTY/BOX
*****	4 1/2 X 1/16 X 5/8	25
*****	5 X 1/16 X 7/8	25
GW709386	7 X 1/16 X 7/8	25

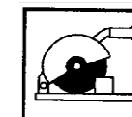
M-4
MEULE À TRONÇONNER POUR SCIE FENDEUSE PORTATIVE
CUT-OFF WHEELS FOR PORTABLE CHOP-SAW
A30N(MÉTAL)**(USAGE GÉNÉRAL , COUPE RAPIDE) / GENERAL PURPOSE, FAST CUTTING)****TYPE 1**

NOTRE CODE	DESCRIPTION	QTÉ/BTE
OUR CODE	DESCRIPTION	QTY/BOX
GW120911	12 X 3/32 X 1	10
GW140909	14 X 3/32 X 1	10
*****	16 X 1/8 X 1	10

A30R (MÉTAL)**(USAGE GÉNÉRAL LONGUE DURÉE) / (GENERAL PURPOSE, LONG LIFE)**

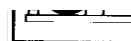
TYPE 1

NOTRE CODE	DESCRIPTION	QTÉ/BTE
OUR CODE	DESCRIPTION	QTY/BOX
GW120910	12 X 3/32 X 1	10
GW140910	14 X 3/32 X 1	10
*****	16 X 1/8 X 1	10

**AA30R (ACIER INOXYDABLE ET MÉTAL)
(COUPE RAPIDE SANS SURCHAUFFE) / (COOL AND FAST CUTTING)**

**TYPE 1**

NOTRE CODE	DESCRIPTION	QTÉ/BTE
OUR CODE	DESCRIPTION	QTY/BOX
*****	12 X 3/32 X 1	10
GW140911	14 X 3/32 X 1	10
*****	16 X 1/8 X 1	10

**M-5**

**MEULES À TRONÇONNER POUR MACHINE STATIONNAIRE
CUT-OFF WHEELS FOR STATIONARY MACHINE**

A30N (MÉTAL)

(USAGE GÉNÉRAL, COUPE RAPIDE) / (GENERAL PURPOSE, FAST CUTTING)



NOTRE CODE	DESCRIPTION	QTÉ/BTE
OUR CODE	DESCRIPTION	QTY/BOX
GW121209	12" X 1/8" X 1"	10
*****	14" X 5/32" X 1"	10
*****	16" X 5/32 X 1"	10

A30R (MÉTAL)

(USAGE GÉNÉRAL, LONGUE DURÉE) / (GENERAL PURPOSE, LONG LIFE)





NOTRE CODE	DESCRIPTION	QTÉ/BTE
OUR CODE	DESCRIPTION	QTY/BOX
GW121210	12" X 1/8" X 1"	10
*****	14" X 5/32" X 1"	10
*****	16" X 5/32 X 1"	10
GW201278	20" X 3/16 X 1"	10



Tel.: (819) 346-2903 / (888) 345-2903 Fax.: (819) 346-3389
 Email: distributeur@boulonsestrie.com

M-6

**MEULES À TRONÇONNER POUR SCIE PORTATIVE À HAUTE VITESSE
 CUT-OFF WHEELS FOR PORTABLE HIGH SPEED POWER SAW**

A24R (MÉTAL)

(USAGE GÉNÉRAL ,LONGUE DURÉE) / (GENERAL PURPOSE, LONG LIFE)

TYPE 1

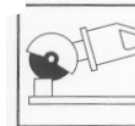

NOTRE CODE	DESCRIPTION	QTÉ/BTE
OUR CODE	DESCRIPTION	QTY/BOX
*****	14 X 1/8 X 20 mm	10
GW141209	14 X 1/8 X 7/8	10
GW141210	14 X 1/8 X 1	10

C24R(BÉTON)

(USAGE GÉNÉRAL, LONGUE DURÉE) / (GENERAL PURPOSE, LONG LIFE)

TYPE 1

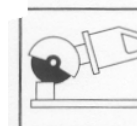

NOTRE CODE	DESCRIPTION	QTÉ/BTE
------------	-------------	---------

OUR CODE	DESCRIPTION	QTY/BOX
GW141220	14 X 1/8 X 20 mm	10
GW141211	14 X 1/8 X 1	10

REDRESSEUR DE MEULES

REDRESSER WHEELS

NOTRE CODE	MODÈLE	TAILLE DE LA MEULE À REDRESSER
OUR CODE	MODEL	FOR WHAT WHEEL DIAMETER
QD599801	NO 0	JUSQU'À / UP TO 10" DIAMETER
*****	NO 1	DE / FROM 10" À / UP TO 16" DIAMETER
*****	NO 2	DE / FROM 16" À / UP TO 36" DIAMETER



AUSSI DISPONIBLE / ALSO AVAILABLE
MOLETTE DE RECHANGE / WHEEL ONLY

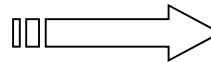

Tel.: (819) 346-2903 / (888) 345-2903 Fax.: (819) 346-3389
Email: distributeur@boulonstrie.com

M-7

MEULES À RECTIFIER POUR MEULEUSE D'ÉTABLI ET SUR PIED BENCH AND PEDESTAL GRINDING WHEELS

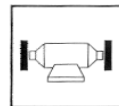

OXYDE D'ALUMINIUM

ALUMINIUM OXYDE

DIMENSIONS	A24	A36	A60	A80	A120	RPM MAX
6" X 1/2 X 1"		*****	*****	*****		4100
6" X 3/4" X 1"	*****	GW067510	*****	GW067512	GW067513	4100
6" X 1" X 1"	*****	*****	*****	*****	GW068010	4100
8" X 1" X 1 1/4"	*****	*****	GW108112	*****	*****	3600
10" X 1" X 1 1/4"	*****	*****	*****	*****	GW110112	2400

CARBURE DE SILICIUM VERT

GREEN SILICON CARBIDE

DIMENSIONS	A60	A80	A120	RPM MAX
6" X 3/4" X 1"	GW067511			4100
6" X 1" X 1"		GW067514		4100

NOTE: ***** = DISPONIBLE / AVAILABLE

AUTRES DIMENSIONS & GRAINS DISPONIBLES / OTHER DIMENSIONS & GRIT ARE AVAILABLE

DISQUES À LAMELLES "POLYFLAP" POLY-FLAP DISCS

ZIRCONIUM, (ENDOS DE FIBRE DE VERRE) / (FIBERGLASS BACKING PLATE)

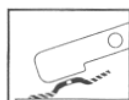

Conçus surtout pour remplacer les disques de sablage, les disques

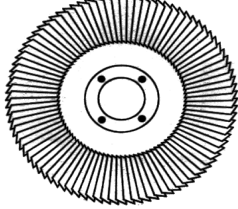

à lamelles Poly-flap sont fabriqués pour vous offrir d'un seul coup
l'ébarbage de soudures, le façonnage et une finition lisse.



POLI-FLAP discs have been developed primarily to replace sanding discs
and to provide a one step operation, from grinding welds to detailed
blending and finishing.

TYPE 27

NOTRE CODE	DESCRIPTION	QTÉ/BTE
OUR CODE	DESCRIPTION	QTY/BOX
GW302200	4 X 5/8 40 GR	10
GW302260	4 1/2 X 7/8 60 GR	10
GW302280	4 1/2 X 7/8 80 GR	10

TYPE 29

NOTRE CODE	DESCRIPTION	QTÉ/BTE
OUR CODE	DESCRIPTION	QTY/BOX
GW302240	4 1/2 X 7/8 40 GR	10
GW305080	5 X 7/8 80 GR	10

M-8

ROUES À FEUILLETS ABRASIFS SUR TIGE MOUNTED FLAP WHEELS

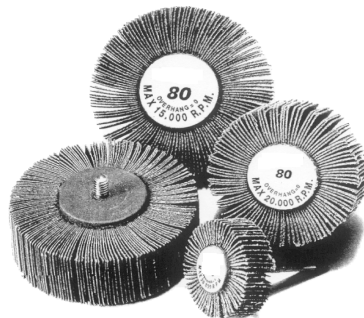

NOTRE CODE	DIA X ÉPAISSEUR	GRAIN
OUR CODE	DIA X WIDTH	GRIT
GW100180	1 X 1	80
GW150580	1 1/2 X 1/2	80
GW150512	1 1/2 X 1/2	120
GW250580	2 1/2 X 1/2	80
GW250512	2 1/2 X 1/2	120
GW301080	3 X 1	80
GW301180	3 X 1	180
GRAND DIAMÈTRE		
GW601080	6 X 1	80
GW601120	6 X 1	120
GW602100	6 X 2	100

AUTRES PRODUITS DISPONIBLE ... OTHER PRODUCTS AVAILABLE...

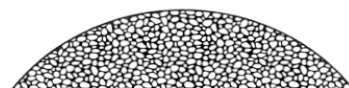

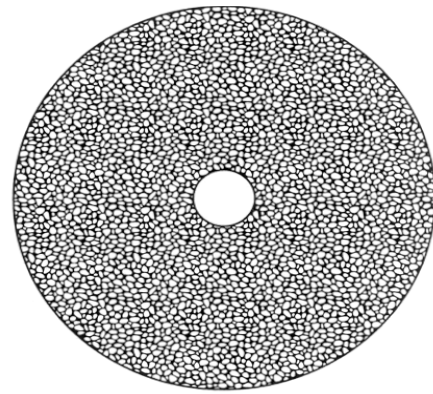
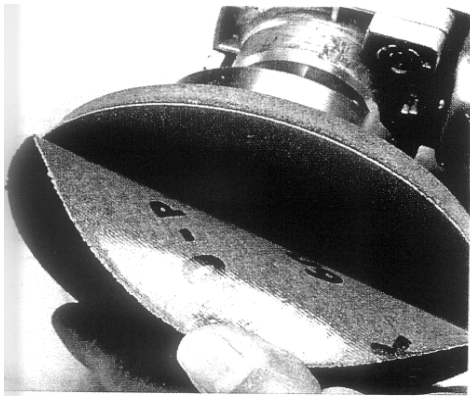

**DISQUES À SABLER AUTOCOLLANT /
ADHESIVE CLOTH DISCS**

**DISQUES A PONCER /
RESIN FIBER DISCS**

RENSEIGNEZ VOUS SUR LES AUTRES PRODUITS DISPONIBLE !



SAIT



M-9

MEULES À RECTIFIER POUR MEULEUSE D'ÉTABLI ET SUR PIED BENCH AND PEDESTAL GRINDING WHEELS

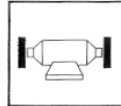

OXYDE D'ALUMINIUM

ALUMINUM OXYDE

DIMENSIONS	A24	A36	A60	A80	A120	RPM MAX
6" X 1/2" X 1"		*****	*****	*****		4100
6" X 3/4" X 1"	*****	GW067510	*****	GW067512	GW067513	4100
6" X 1" X 1"	*****	*****	*****	*****	GW068010	4100
8" X 1" X 1 1/4"	*****	*****	GW108112	*****	*****	3600
10" X 1" X 1 1/4"	*****	*****	*****	*****	*****	2400

CARBURE DE SILICIUM VERT

GREEN SILICON CARBIDE

DIMENSIONS	A60	A80	A120	RPM MAX
6" X 3/4" X 1"	GW067511	*****	*****	4100
6" X 1" X 1"	*****	GW067514		4100

*NOTE: ***** = DISPONIBLE / AVAILABLE*

AUTRES DIMENSIONS & GRAINS DISPONIBLES / OTHER DIMENSIONS & GRIT ARE AVAILABLE

DISQUES À LAMELLES "POLYFLAP" POLY-FLAP DISCS

ZIRCONIUM, (ENDOS DE FIBRE DE VERRE) / (FIBERGLASS BACKING PLATE)

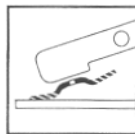
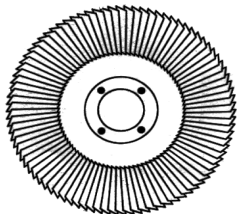

Conçus surtout pour remplacer les disques de sablage. Les disques à lamelles Poly-flap sont fabriqués pour vous offrir d'un seul coup l'ébarbage de soudures, le façonnage et une finition lisse.

POLI-FLAP discs have been developed primarily to replace sanding discs and to provide a one step operation, from grinding welds to detailed blending and finishing.

TYPE 27

NOTRE CODE	DESCRIPTION	QTÉ/BTE
OUR CODE	DESCRIPTION	QTY/BOX
GW302200	4 X 5/8 40 GR	10
GW302260	4 1/2 X 7/8 60 GR	10
GW302280	4 1/2 X 7/8 80 GR	10

TYPE 29

NOTRE CODE	DESCRIPTION	QTÉ/BTE
OUR CODE	DESCRIPTION	QTY/BOX
GW302240	4 1/2 X 7/8 40 GR	10
GW305080	5 X 7/8 80 GR	10



**ROUES À FEUILLETS ABRASIFS SUR TIGE
MOUNTED FLAP WHEELS**

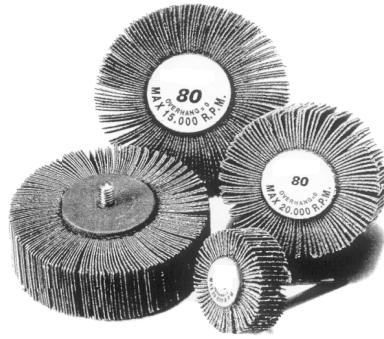

NOTRE CODE	DIA X ÉPAISSEUR	GRAIN
OUR CODE	DIA X WIDTH	GRIT
GW100180	1 X 1	80
GW150580	1 1/2 X 1/2	80
GW150512	1 1/2 X 1/2	120
GW250580	2 1/2 X 1/2	80
GW250512	2 1/2 X 1/2	120
GW301080	3 X 1	80
GW301180	3 X 1	180
GRAND DIAMÈTRE		
GW601080	6 X 1	80
GW601120	6 X 1	120
GW602100	6 X 2	100

AUTRES PRODUITS DISPONIBLE ... OTHER PRODUCTS AVAILABLE...

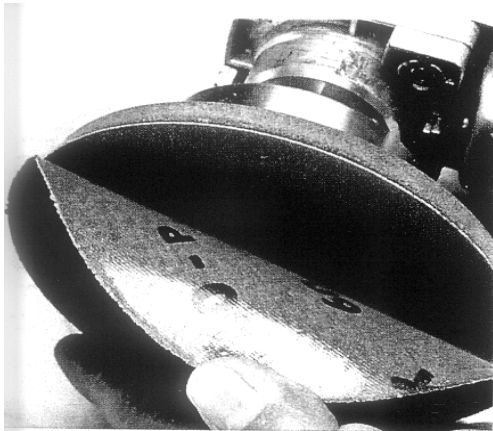

**DISQUES À SABLER AUTOCOLLANT /
ADHESIVE CLOTH DISCS**

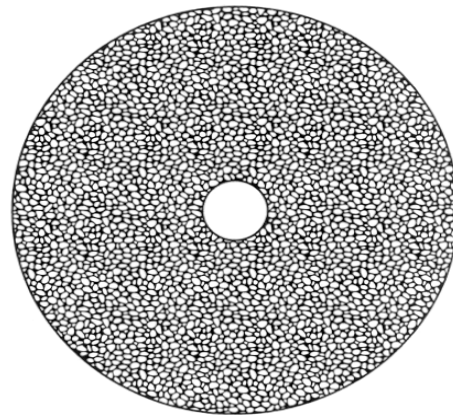

**DISQUES A PONCER /
RESIN FIBER DISCS**

RENSEIGNEZ VOUS SUR LES AUTRES PRODUITS DISPONIBLE !



PAPERS SABLÉS
OXYDE D'ALUMINIUM

COATED ABRASIVE
SHEETS ALUMINUM OXYDE
"CLOTH BACK"



NOTRE CODE	DIMENSION	GRAIN	QTÉ/BTE
OUR CODE	SIZE	GRIT	QTY/BOX
QP910040	9 X 11	40	100
QP910050	9 X 11	50	100
QP910060	9 X 11	60	100
QP910080	9 X 11	80	100
QP910100	9 X 11	100	100
QP910120	9 X 11	120	100
QP910150	9 X 11	150	100
QP910180	9 X 11	180	100
QP910220	9 X 11	220	100
QP910240	9 X 11	240	100
QP910320	9 X 11	320	100
QP910400	9 X 11	400	100

ROULEAUX PRATIQUES

HANDY ROLLS



NOTRE CODE	DIMENSION	GRAIN
OUR CODE	SIZE	GRIT
QR150040	1 1/2 X 50 V	40
QR150050	1 1/2 X 50 V	50
QR150060	1 1/2 X 50 V	60
QR150080	1 1/2 X 50 V	80
QR150100	1 1/2 X 50 V	100
QR150120	1 1/2 X 50 V	120
QR150150	1 1/2 X 50 V	150
QR150180	1 1/2 X 50 V	180
QR150220	1 1/2 X 50 V	220
QR150240	1 1/2 X 50 V	240
QR150320	1 1/2 X 50 V	320
QR150400	1 1/2 X 50 V	400

1" ET 2" SONT DISPONIBLES / 1" & 2" ARE AVAILABLE

M-10

COURROIES À SABLER
USAGE GÉNÉRAL
TOILE D'OXYDE
D'ALUMINIUM

ALUMINUM OXYDE
OPEN COAT ABRASIVE BELTS



CE QUE NOUS AVONS EN INVENTAIRE / WHAT WE HAVE IN STOCK

NOTRE CODE	DIMENSION	GRAIN
OUR CODE	SIZE	GRIT
QB042410	4 X 24	100 G
QB042420	4 X 24	120 G
QB042450	4 X 24	50 G
QB042480	4 X 24	80 G
QB046460	6 X 48	60 G
QB046480	6 X 48	80 G

AUSSI DISPONIBLE / ALSO AVAILABLE

DIMENSIONS / SIZES

1" X 30"

1" X 42"

2" X 48"

3" X 18"

3" X 21"

3" X 24"

4" X 21"

4" X 36"

6" X 48"



Tel.: (819) 346-2903 / (888) 345-2903 Fax.: (819) 346-3389

Email: distributeur@boulonsestrie.com

M-11

BROSSES D'ACIER**WIRE BRUSHES****BROSSES À LA MAIN
MANCHE COURBÉ****SCRATCH BRUSHES
CURVED HANDLE**

NOTRE CODE	DIAMÈTRE	FIL	TYPE
OUR CODE	SIZE	WIRE	TYPE
Q0030190	3 X 19	0,012	STAINLESS
Q0040190	4 X 19	0,014	CARBON STEEL

**BROSSE À FILS NOUÉS ACIER AU CARBONE****KNOT WIRE CARBON STEEL**

NOTRE CODE	DIA. X FIL X TROU
OUR CODE	DIA. X WIRE X ARBOR
Q0046251	4" X 0.020 X 5/8-11

**BROSSES À FILS CRÊPÉS ACIER AU CARBONE****CRIMPED WIRE CARBON STEEL**

NOTRE CODE	DIA. X FIL X TROU
OUR CODE	DIA. X WIRE X ARBOR
Q0046250	4" X 0.020 X 5/8-11
Q0056250	5" X 0.020 X 5/8-11
Q0066250	6" X 0.020 X 5/8-11

**BROSSES À FILS CRÊPÉS
POUR MEULEUSE D'ÉTABLIE****CRIMPED WIRE CARBON STEEL
FOR BENCH OR STRAIGHT SHAFT GRINDERS**













NOTRE CODE	DIA. X FIL X TROU
OUR CODE	DIA. X WIRE X ARBOR
OU066100	6" X 0.014 X 5/8,1/2
OU13B070	7" X 0.014 X 5/8
OU088711	8" X 0.014 X 5/8

**AUTRES DIMENSIONS DISPONIBLES / OTHER DIMENSIONS AVAILABLE****Tel.: (819) 346-2903 / (888) 345-2903 Fax.: (819) 346-3389****Email: distributeur@boulonsestrie.com****M-12**

SECTION N







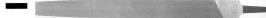

LIMES / FILES

INFORMATION TECHNIQUE.....DÉBUT DE LA SECTION
TECHNICAL INFORMATION.....BEGINNING OF THIS SECTION

DESCRIPTION	SECTION-PAGE
 <p>LIMES PLATES, COUPE DOUCE, BÂTARDE & DEMI-DOUCE. FLAT FILES, SMOOTH, BASTARD & 2ND CUT.</p>	N-2
 <p>LIMES POUR SCIE À CHAÎNE RONDE. CHAIN SAW ROUND FILES.</p>	N-1
 <p>LIMES PLATES POUR ALUMINIUM. ALUMINUM FLAT FILES.</p>	N-1
 <p>LIMES CARRÉES, COUPE BÂTARDE. SQUARE FILES, BASTARD CUT.</p>	N-6
 <p>LIMES CARRÉES, COUPE DEMI-DOUCE. SQUARE FILES, 2ND CUT.</p>	SUR DEMANDE ON REQUEST
 <p>LIMES CARRÉES, COUPE DOUCE. SQUARE FILES, SMOOTH CUT.</p>	SUR DEMANDE ON REQUEST
 <p>LIMES À MACHINISTE. LONG ANGLE LATHE.</p>	N-6
 <p>LIME POUR MÈCHES À BOIS. AUGER BIT.</p>	N-6
 <p>LIMES RONDES , COUPE BÂTARDE. ROUND FILES, BASTARD CUT.</p>	N-5
 <p>LIMES RONDES, COUPE DEMI-DOUCE. ROUND FILES, 2ND CUT.</p>	SUR DEMANDE ON REQUEST
 <p>LIMES RONDES, COUPE DOUCE. ROUND FILES, SMOOTH CUT.</p>	N-5
 <p>LIMES DEMI-RONDES, COUPE BÂTARDE. HALF ROUND FILES, BASTARD CUT.</p>	N-4
 <p>LIMES DEMI-RONDES, COUPE DEMI-DOUCE. HALF ROUND FILES, 2ND CUT.</p>	N-4

SECTION N

LIMES / FILES

DESCRIPTION	SECTION-PAGE
 <p>LIMES DEMI-RONDES, COUPE DOUCE. HALF ROUND FILE, SMOOTH CUT.</p>	N-4
 <p>LIMES À PARER, COUPE BÂTARDE. MILL FILES, BASTARD CUT.</p>	N-3
 <p>LIMES À PARER, COUPE DEMI-DOUCE. MILL FILES , 2ND CUT.</p>	N-3
 <p>LIMES À PARER, COUPE DOUCE. MILL FILES, SMOOTH CUT.</p>	N-3
 <p>LIMES COUTEAU, COUPE BÂTARDE, DOUCE & DEMI-DOUCE. KNIFE FILES, BASTARD, SMOOTH & 2ND CUT.</p>	SUR DEMANDE ON REQUEST
 <p>LIMES "CROSS-CUT", TAILLE SIMPLE. "CROSS-CUT" FILES, SIMPLE CUT.</p>	SUR DEMANDE ON REQUEST
 <p>LIMES TIERS-POINT. TAPER SAW.</p>	SUR DEMANDE ON REQUEST
 <p>MANCHES DE LIME EN BOIS. WOOD FILE HANDLES.</p>	N-7
 <p>BROSSE POUR NETTOYER LES LIMES. FILE CARD TO CLEAN FILES.</p>	N-7



Tel.: (819) 346-2903 / (888) 345-2903 Fax.: (819) 346-3389
Email: distributeur@boulonsestrie.com

DESCRIPTION

LIMES TOUT USAGE

Page N-1

ALL PURPOSE FILES



La poignée moulée donne une grande aisance et permet une utilisation multiple de cette lime.
La lime tout usage produit une action de coupe double d'un côté et une coupe simple de l'autre.

The built-in handle provides maximum versatility for a wide range of applications.
All-Purpose Files feature a double cut on one side,
a single cut on the other side, have one edge cut and one edge safe (uncut) for
shoulder filing, and are parallel in width and thickness.

**LIMES POUR SCIE
À CHAÎNE, RONDES**

Page N-1

**CHAIN SAW
ROUND**



Lime spécialement conçue pour l'entretien et l'affûtage des dents de tronçonneuse.
Taille simple, affutage rapide laissant un excellent fini.

Used for sharpening and maintaining proper tooth shape on chain saws.
Round Chain Files have a fast, smooth cutting action that leaves an excellent
" keen " edge cutting finish.

**LIMES PLATES
POUR ALUMINIUM**

Page N-1

**ALUMINIUM
FLAT FILES**



Elle est conçue pour limer les pièces en aluminium ou en alliage d'aluminium.
Elle permet d'obtenir un fini lisse en donnant un effet vers la gauche.
Elle ne s'encrasse pas, a le même nombre de dents au pouce dans chacune des longueurs.
Elle permet une taille croisée.
Style Américain.

Aluminium Files have a coarse, fast cutting tooth design that is very effective in
eliminating clogging.
Developed for use on soft materials, such as Aluminum Flat Files are double cut and taper
toward the point in width.
American Pattern Files

INFO TECHNIQUE N (T-1)

DESCRIPTION

LIMES PLATES

FLAT FILES

Page N-2

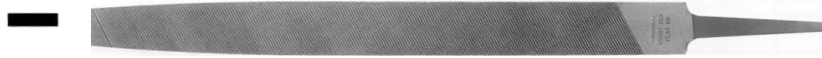

Lime excellente pour l'enlèvement rapide du métal.
Elles possèdent deux faces à taille croisée et les chants à taille simple.
Cette lime est effilée en largeur et amincie en épaisseur vers le bout et est du style Américain.
Elles sont disponibles en coupe bâtarde , demi-douce et en coupe douce.

Excellent for " hogging " or rapid stock removal; Flat Files are double cut on both sides, single cut on the edges and taper toward the point in width.
Simonds Flat Files feature the exclusive " Wavy tooth " design.
Available in bastard , 2nd cut, smooth cutting.

LIMES À PARER

MILL FILES

Page N-3



Conçues spécialement pour l'affûtage des lames de scies circulaires.
Elles possèdent deux chants carrés, et toutes les largeurs sont légèrement effilées en largeur.
Elles sont de forme rectangulaires et du style Américain.
Elles sont disponibles en coupe bâtarde, demi-douce et en coupe douce.

Excellent for a wide range of applications such as sharpening, draw filing, lathe work and general shop use; Mill Files are single cut on the sides and edges, and taper toward the point in width.

LIMES DEMI-RONDES

HALF ROUND FILES

Page N-4



Elles sont conçues pour les surfaces concaves, convexes et plates. Arrondies sur un côté et plate de l'autre. Les limes de coupe bâtarde et demi-douces arrondies de plus de 6" ont une taille croisée de l'autre côté. Tandis que toutes celles de 4" et 6" ont une taille simple de l'autre côté. De même que toutes les limes de coupe douce arrondies sont elles aussi de taille simple de l'autre côté. Le côté plat de toutes les limes est de taille croisée.

Superb for rounding out holes, corners and crevices; Half Round Files are double cut on both sides and taper toward the point in width and thickness. Simonds Half Round Files feature a built in "Twist & Roll" action on the half round side produced by the Simonds " Spiral Cut" design and have the exclusive " wavy tooth" desing on the flat side.

DESCRIPTION

LIMES RONDES

ROUND FILES

Page N-5



Excellentes pour les travaux sur surfaces concaves ou pour finir ou agrandir les ouvertures circulaires. Les limes rondes sont disponibles en coupe bâtarde, demi-douce et douce. Légèrement effilées vers l'extrémité. Les limes de 4, 5, 6, 8, 10, 12" ont une taille simple. Les limes de coupe bâtarde de 14" ont une taille croisée. (Souvent appelé " Queue de rat ")

Intended for enlarging and rounding out circular openings or concave surfaces; Round Files have double cut and taper toward the point in width and thickness. (Round Files are often referred to as " Rat tail " Files.)

LIMES CARRÉES

SQUARE FILES

Page N-6



Elles sont conçues pour limer les fentes, les trous de serrures ou toutes surfaces en général. Les limes carrées ont une taille croisée et du style Américain. Elles sont légèrement effilées vers l'extrémité. Elles sont parfois utilisées à la place des limes plates car elles sont plus épaisses et comptent 4 faces de limage. Elles sont disponibles en coupe bâtarde, demi-douce et douce.

Created for slots, keyways, square holes or general surface filling; Square Files have double cut and taper toward the point in width and thickness. Simonds Square Files feature the exclusive " Wavy Tooth " design.

LIMES À MACHINISTE

LONG ANGLE LATHE

Page N-6



Elles sont conçues principalement pour le travail des machinistes sur les tours et établis. La coupe dessinée sur un angle allongé permet un limage rapide et laisse un doux fini. Les limes ont une taille croisée.

Primarily for lathe work and bench filing; Long Angle Lathe Files have single cut both edges safe (uncut) and taper toward the point in width. The teeth are designed on a " long angle " to provide free cutting and rapid filing while leaving a smooth finish.

DESCRIPTION

LIMES POUR MÈCHES À BOIS

AUGER BIT

Page N-6



Utilisées pour faire des retouches sur le tranchant des Auger bits.

La lime Auger a un côté coupant avec rebord sécuritaire et un rebord coupant avec côté sécuritaire; le tout est mesuré sur la longueur totale de la lime.

Used to touch-up the cutting edges on auger bits; Auger Bit Files have one end single cut with safe edges, one end safe (uncut) with single cut edges, and are measured on the overall length.

**LIMES
TYPE LAME
DE COUTEAU**

Page N-7

**FILES
KNIFE TYPE**



Elles sont conçues pour limer les fentes, les trous de serrures et les angles aigus.

Les limes type lame de couteau ont une taille croisée. Elles ont une taille simple sur le tranchant du couteau mais sécuritaire de l'autre. Elles sont légèrement effilées vers l'extrémité. Elles sont disponibles en coupe bâtarde, demi-douce et douce.

For use on slots, keyways and acute angles; Knife Files have double cut on both sides, single cut on the "knife edge" with a safe (uncut) back and taper toward the point in width and thickness. Simonds knife Files feature the exclusive "Wavy tooth" design. Knife Files are available in bastard, second cut and smooth.

**LIMES "CROSS-CUT"
TAILLE SIMPLE**

Page N-7

**"CROSS-CUT" FILES
SINGLE CUT**



Originellement conçues pour l'affûtage des scies " Great American " elles sont aussi efficaces pour arrondir les gorges des dents des autres types de scies. Elles ont une forme en cale avec un dos arrondi. Elles ont une taille simple sur les cotés, le dos et sur le rebord mince.

Originally made for sharpening " Great American " type cross-cut saws, but also effective for rounding out gullets on other various types of saws. Cross-cut Files are wedge-shaped with a rounded back. They're single cut on the sides, the back and the thin edge.

INFO TECHNIQUE N (T-4)

DESCRIPTION

LIMES TIERS-POINT

TAPER SAW

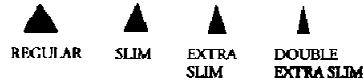

Page N-7



Ces limes sont conçues pour l'affûtage de tous les types de scies dont les dents font un angle de 60°. Les limes tiers-point ont une forme triangulaire.

Elles ont une taille simple, et du style Américain.

Les arrêtes sont taillées pour le limage des gorges des dents de scie.

Designed for filing all types of saws with 60° angle teeth; Taper Saw Files are triangular in shape, have cut edges, and taper toward the point and thickness.

COUPE BÂTARDE

COUPE DEMI-DOUCE

COUPE DOUCE

BASTARD CUT

SECOND CUT

SMOOTH CUT



Tel.: (819) 346-2903 / (888) 345-2903 Fax.: (819) 346-3389

Email: distributeur@boulonsestrie.com

INFO TECHNIQUE N (T-5)

DESCRIPTION

TAILLE SIMPLE SINGLE CUT

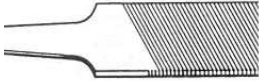

- * Une lime à taille simple comporte un ensemble unique d'entailles parallèles.
 - * Ces limes sont utilisées avec une légère pression pour produire une surface lisse ou pour aiguiser couteaux, cisailles ou scies.
-

- * Single cut files are consisting of parallel groove.
 - * Those files are developed to be used with a light pressure to produce a smooth surface finish or to sharpen saw, knife and shears.
-

TAILLE CROISÉE CROSS CUT

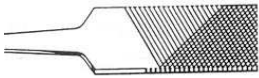

- * 2 ensembles croisés d'entailles parallèles en diagonale.
 - * Un 2^e ensemble d'entailles se superpose au premier et est incliné dans l'autre sens.
 - * Le premier ensemble: Taille primaire / Le deuxième: Taille secondaire.
 - * La taille secondaire est plus fine que la taille primaire.
 - * Les limes à taille croisée sont utilisées avec une pression plus forte que les limes à taille simple pour l'enlèvement rapide du métal.
-

- * 2 sets of parallel groove diagonally.
 - * Another set of groove are superimposed to the first set and tilt to the opposite way.
 - * First set : Primary cut / Second set : secondary cut.
 - * The secondary cut is smoother than the primary cut.
 - * Cross cut files are used with a stronger pressure than the single cut file for fast steel removal.
-

TAILLE DE RÂPE RASP CUT



- * La denture des râpes est constituée de dents individuelles, formées à l'aide d'un outil pointu.
 - * Ce type de taille grossière permet surtout de travailler le bois, l'aluminium et le plomb.
-

- * The jagged outline is constituted of individual tooth shaped with a pointed tool.
- * This coarse cutting type is developed for wood, aluminum and lead work.

DESCRIPTION

DESCRIPTION

DESCRIPTION

DESCRIPTION

DESCRIPTION

DESCRIPTION

DESCRIPTION

DESCRIPTION

DESCRIPTION

DESCRIPTION

DESCRIPTION

TYPE AMÉRICAIN / AMERICAN PATTERN FILE

**LIMES POUR SCIE
À CHAÎNE, RONDES**

**CHAIN SAW
ROUND FILES**



NOTRE CODE	DESCRIPTION	QTÉ/BTE
OUR CODE	DESCRIPTION	QTY/BOX
Q7374011	1/8 X 6	12
Q7374021	5/32 X 6	12
Q7374031	3/16 X 8	12
Q7374061	7/32 X 8	12
73-740910	1/4 X 8	12
73-741510	5/16 X 8	12
73-741810	3/8 X 8	12

**LIMES PLATES
POUR ALUMINIUM**

**ALUMINUM
FLAT FILES**

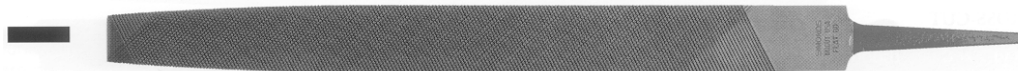

NOTRE CODE	DESCRIPTION	QTÉ/BTE
OUR CODE	DESCRIPTION	QTY/BOX
73-274500	6"	12
73-275000	8"	12
73-275500	10"	12
Q7327600	12"	6



Tel.: (819) 346-2903 / (888) 345-2903 Fax.: (819) 346-3389

Email: distributeur@boulonsestrie.com

TYPE AMÉRICAIN / AMERICAN PATTERN FILE

LIMES PLATES

BÂTARDE / BASTARD

FLAT FILES

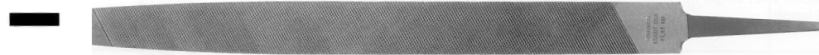

NOTRE CODE	DESCRIPTION	QTÉ/BTE
OUR CODE	DESCRIPTION	QTY/BOX
Q7322700	4"	12
Q7322950	6"	12
Q7323200	8"	12
Q7323400	10"	12
Q7323600	12"	6
Q7323800	14"	6
73-239500	16"	6

DEMI-DOUCE / 2ND CUT

NOTRE CODE	DESCRIPTION	QTÉ/BTE
OUR CODE	DESCRIPTION	QTY/BOX
Q7322750	4"	12
Q7323000	6"	12
Q7323250	8"	12
Q7323450	10"	12
Q7323650	12"	6
Q7323850	14"	6

DOUCE / SMOOTH

NOTRE CODE	DESCRIPTION	QTÉ/BTE
OUR CODE	DESCRIPTION	QTY/BOX
Q7322800	4"	12
Q7323050	6"	12
Q7323300	8"	12
Q7323500	10"	12
Q7323700	12"	6
Q7323900	14"	6



Tel.: (819) 346-2903 / (888) 345-2903 Fax.: (819) 346-3389

Email: distributeur@boulonsestrie.com

TYPE AMÉRICAIN / AMERICAN PATTERN FILE

LIMES À PARER

BÂTARDE / BASTARD

MILL FILES



NOTRE CODE	DESCRIPTION	QTÉ/BTE
OUR CODE	DESCRIPTION	QTY/BOX
Q7314050	4"	12
Q7314300	6"	12
Q7314550	8"	12
Q7314750	10"	12
Q7314950	12"	6
Q7321550	14"	6
*****	16"	6

DEMI-DOUCE / 2 ND CUT

NOTRE CODE	DESCRIPTION	QTÉ/BTE
OUR CODE	DESCRIPTION	QTY/BOX
73-141000	4"	12
73-143500	6"	12
73-146000	8"	12
73-148000	10"	12
73-150000	12"	6
73-152000	14"	6

DOUCE / SMOOTH

NOTRE CODE	DESCRIPTION	QTÉ/BTE
OUR CODE	DESCRIPTION	QTY/BOX
Q7314150	4"	12
Q7314400	6"	12
Q7314650	8"	12
Q7314850	10"	12
Q7315050	12"	6
Q7315250	14"	6



Tel.: (819) 346-2903 / (888) 345-2903 Fax.: (819) 346-3389

Email: distributeur@boulonsestrie.com

TYPE AMÉRICAIN / AMERICAN PATTERN FILE

LIMES DEMI-RONDES

BÂTARDE / BASTARD

HALF ROUND FILES



NOTRE CODE	DESCRIPTION	QTÉ/BTE
OUR CODE	DESCRIPTION	QTY/BOX
Q7331500	4"	12
Q7331700	6"	12
Q7331900	8"	12
Q7332100	10"	12
Q7332300	12"	6
Q7332500	14"	6
Q7332700	16"	6

DEMI-DOUCE / 2 ND CUT

NOTRE CODE	DESCRIPTION	QTÉ/BTE
OUR CODE	DESCRIPTION	QTY/BOX
73-315000	4"	12
73-317500	6"	12
73-319500	8"	12
Q7332150	10"	12
73-323500	12"	6
Q7332350	14"	6

DOUCE / SMOOTH

NOTRE CODE	DESCRIPTION	QTÉ/BTE
OUR CODE	DESCRIPTION	QTY/BOX
Q7331600	4"	12
Q7331800	6"	12
Q7332000	8"	12
Q7332200	10"	12
Q7332400	12"	6
73-326000	14"	6



Tel.: (819) 346-2903 / (888) 345-2903 Fax.: (819) 346-3389

Email: distributeur@boulonsestrie.com

TYPE AMÉRICAIN / AMERICAN PATTERN FILE

LIMES RONDES

BÂTARDE / BASTARD

ROUND FILES



NOTRE CODE	DESCRIPTION	QTÉ/BTE
OUR CODE	DESCRIPTION	QTY/BOX
Q7339300	4"	12
Q7339600	6"	12
Q7339850	8"	12
Q7340050	10"	12
Q7340250	12"	6
Q7340450	14"	6

DOUCE / SMOOTH

NOTRE CODE	DESCRIPTION	QTÉ/BTE
OUR CODE	DESCRIPTION	QTY/BOX
Q7339400	4"	12
Q7339700	6"	12
Q7339950	8"	12
Q7340150	10"	12
Q7340350	12"	6

****LES LIMES DEMI-DOUCE
SONT DISPONIBLES****

**** THE 2 ND CUT FILES ARE
AVAILABLE****



Tel.: (819) 346-2903 / (888) 345-2903 Fax.: (819) 346-3389

Email: distributeur@boulonsestrie.com

TYPE AMÉRICAIN / AMERICAN PATTERN FILE

LIMES CARRÉES

BÂTARDE / BASTARD

SQUARE FILES



NOTRE CODE	DESCRIPTION	QTÉ/BTE
OUR CODE	DESCRIPTION	QTY/BOX
Q7342500	4"	12
Q7342800	6"	12
Q7343000	8"	12
Q7343200	10"	12
Q7343400	12"	6
Q7343600	14"	6

****LES LIMES DEMI-DOUCE
ET DOUCE SONT DISPONIBLES**

****THE FILES 2ND CUT AND
SMOOTH ARE AVAILABLE**

LIMES À
MACHINISTE



LONG ANGLE
LATHE

NOTRE CODE	DESCRIPTION	QTÉ/BTE
OUR CODE	DESCRIPTION	QTY/BOX
Q7325550	10"	12
Q7325600	12"	6
Q7343000	14"	6

LIME POUR MÈCHE À BOIS

AUGER BIT



NOTRE CODE	DESCRIPTION	QTÉ/BTE
OUR CODE	DESCRIPTION	QTY/BOX
Q7358050	7"	12



Tel.: (819) 346-2903 / (888) 345-2903 Fax.: (819) 346-3389

Email: distributeur@boulonsestrie.com

TYPE AMÉRICAIN / AMERICAN PATTERN FILE

LIMES TYPE LAME DE COUPEAU

**CES LIMES SONT
DISPONIBLES
BÂTARDE
DEM-DOUCE
DOUCE**



**KNIFE FILES
THE KNIFE FILES
ARE AVAILABLE**

**BASTARD
SECOND CUT
SMOOTH**

LIMES "CROSS-CUT"





TAILLE SIMPLE



"CROSS-CUT" FILES

SINGLE CUT

LIMES TIERS-POINT

 REGULAR
  SLIM
  EXTRA SLIM
  DOUBLE EXTRA SLIM



TAPER SAW

MANCHES DE LIME EN BOIS



WOOD FILE HANDLES

NOTRE CODE	NO DE MANCHE	DESCRIPTION
OUR CODE	HANDLE NO	DESCRIPTION
Q7339250	2	POUR LIME 4" / FOR 4" FILE
Q7339260	4	POUR LIME 6" / FOR 6" FILE
Q7339270	5	POUR LIME 8" / FOR 8" FILE
Q7339280	6	POUR LIME 10" / FOR 10" FILE
Q7339290	7	POUR LIME 12" / FOR 12" FILE
Q7339295	8	POUR LIME 14" / FOR 14" FILE

BROSSE POUR NETTOYER

LES LIMES



**FILE CARD
TO CLEAN FILES**

NOTRE CODE	DESCRIPTION	QTÉ/BTE
OUR CODE	DESCRIPTION	QTY/BOX
Q7399300	CARDE À LIME 8"	1

SIMONDS



Tel.: (819) 346-2903 / (888) 345-2903 Fax.: (819) 346-3389





Email: distributeur@boulonsestrie.com

N-7

SECTION O

OUTILS À MAIN ET ÉLECTRIQUES/ MANUAL AND ELECTRIC TOOLS

INFORMATION TECHNIQUE.....DÉBUT DE LA SECTION
TECHNICAL INFORMATION.....BEGINNING OF THIS SECTION

	DESCRIPTION	SECTION-PAGE
	SCIES CIRCULAIRES PIED PIVOTANT. PIVOT FOOT CIRCULAR SAWS.	O-1
	TRONÇONNEUSE. CUT-OFF MACHINE .	O-1
	SCIE À ONGLET COMBINÉ. COMPOUND MITRE SAW.	O-2
	SABLEUSES À BANNIÈRE. BELT SANDERS.	O-2
	RECTIFIEUSES À ANGLE. ANGLE GRINDERS.	O-3
	RECTIFIEUSES À ANGLE DROIT. RIGHT ANGLE GRINDERS.	O-4
	FUSIL À AIR CHAUD. HEAT GUN.	O-9
	ENSEMBLES DE PERCEUSE (VOLT). BATTERY PACK KITS.	O-6
	ENSEMBLE PERCEUSE 24 VOLT. 24 VOLT DRILL DRIVER KIT.	O-10
	ENSEMBLE PERCEUSE AVEC COFFRE. DRILL KIT.	O-5
	PERCEUSE FORCE INTENSE 1/2". HIGH TORQUE HEAVY DUTY DRILL - 1/2" DRIVE .	O-5
	PERCEUSES MARTEAU (S.D.S.) HAMMER DRILLS (S.D.S.)	O-7











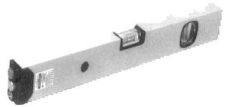

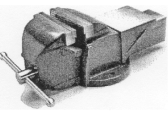

SECTION O

OUTILS À MAIN ET ÉLECTRIQUES/ MANUAL AND ELECTRIC TOOLS

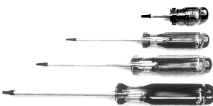
DESCRIPTION	SECTION-PAGE
 <p>SCIE SAUTEUSE. JIGSAW.</p>	O-8
 <p>PERCEUSE À ANGLE DROIT. RIGHT ANGLE DRILL.</p>	O-9
 <p>ENSEMBLE SCIE PASSE PARTOUT. RECIPROCATING SAW KIT.</p>	O-9
 <p>PILES. BATTERIES.</p>	O-10
 <p>CLÉS MANCHE "T". CHUCK KEYS.</p>	O-10
 <p>PINCES DIVERSES. VARIOUS TYPE OF PLIERS.</p>	O-11...O-13
 <p>CISAILLES TYPE AVIATION. AVIATION SNIPS.</p>	O-14
 <p>SCIE À MÉTAL, LAME 12". 12" BLADE HACKSAW.</p>	SUR DEMANDE ON REQUEST
 <p>CISAILLES DE FERBLANTIER. STRAIGHT PATTERN SNIPS.</p>	O-14
 <p>CLÉS À MOLETTE STANDARD. ADJUSTABLE WRENCH.</p>	O-14
 <p>PINCE "CHANNEL LOCK". UTILITY PIPE PLIERS.</p>	O-15
 <p>PINCE À CLÔTURE. FENCE PLIERS.</p>	O-15
 <p>RUBANS À MESURER. MEASURING TAPES.</p>	O-23
 <p>OUTIL DE MESURE ÉLECTRONIQUE. DIGITAL GALIPERS.</p>	O-23

SECTION O

OUTILS À MAIN ET ÉLECTRIQUES/ MANUAL AND ELECTRIC TOOLS

DESCRIPTION	SECTION-PAGE
 <p>NIVEAU AU LASER. LASER LEVEL.</p>	0-23
 <p>BARRES À CLOUS. WRECKING BARS.</p>	0-15
 <p>MARTEAUX. HAMMERS.</p>	0-15
 <p>BARRES DE LEVAGE. PRY BARS.</p>	SUR DEMANDE ON REQUEST
 <p>ÉTAUX AVEC ENCLUME. VISES WITH ANVIL.</p>	0-17
 <p>PLATEAUX TOURNANT. SWIVEL BASES ONLY.</p>	0-17
 <p>SERRES EN "C". "C" CLAMPS.</p>	0-17
 <p>OUTILS DE GRAISSAGE. GREASE GUNS TOOLS.</p>	0-18
 <p>TOURNEVIS DIVERS. SCREWDRIVERS.</p>	0-21
 <p>DOUILLES CARRÉES & ÉTOILES. SQUARE & PHILIPS BITS.</p>	0-22
 <p>PRISES MAGNÉTIQUES. MAGNETIC SOCKETS.</p>	0-22
 <p>HUILIERS. OILERS.</p>	0-19
 <p>ENTONNOIR. FUNNEL.</p>	0-19
 <p>BURINS & POINÇONS. CHISELS & PUNCHES.</p>	0-16

BOSCH

SCIE CIRCULAIRE PIED PIVOTANT /
PIVOT FOOT CIRCULAR SAW

NO: RB001655

7 1/4



VOLTAGE / RATING : 120 V AC/DC

AMPÉRAGE / AMPERAGE : 15.0

BOSCH

SCIE À ONGLET COMBINÉ / COMPOUND MITRE SAW

NO: RB003912

12"

VOLTAGE / RATING: 120 AC
AMPÉRAGE / AMPERAGE: 15.0
PUISSANCE MAX EN CHEVAUX VAPEUR/
MAX TOOL HORSEPOWER: 3,3
DIMENSION DE LA LAME /BLADES SIZE :
12" AVEC / WITH 1" MANDRIN/ARBOR

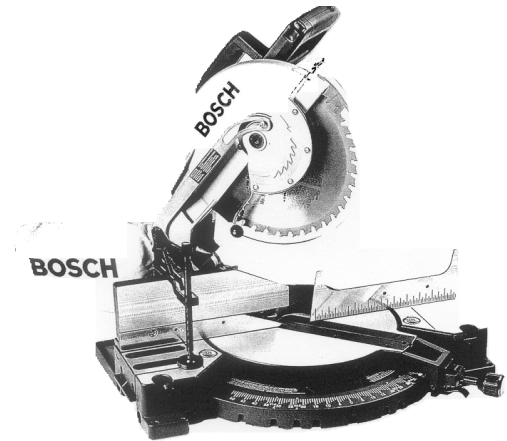

SABLEUSES À BANNIÈRE / BELT SANDERS

NO: RB01274D

3 X 21

VOLTAGE / RATING: 120V AC
AMPÉRAGE / AMPERAGE: 6,6
LONGUEUR DE LA BANNIÈRE/
BELT SIZE : 3 X 21

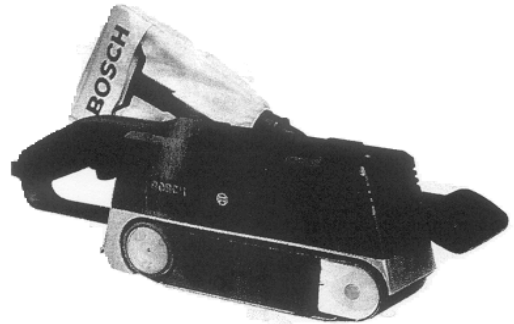

NO:RB01276D

4 X 24

VOLTAGE / RATING: 120V AC
AMPÉRAGE / AMPERAGE: 10,5
LONGUEUR DE LA BANNIÈRE /
BELT SIZE: 4 X 24

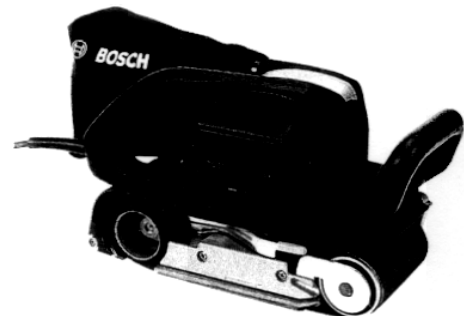

Tel.: (819) 346-2903 / (888) 345-2903 Fax.: (819) 346-3389

Email: distributeur@boulonsestrie.com

**RECTIFIEUSES À ANGLE/
ANGLE GRINDERS**

NO: RB01375A

4 1/2

VOLTAGE / RATING: 120V AC
AMPÉRAGE / AMPERAGE: 6.0
GRANDEUR DE LA MEULE / WHEEL SIZE: 4 1/2
**PUISSANCE MAX. DE L'OUTIL/
MAX. TOOL HORSEPOWER: 1.0**
ARBRE / SPINDLE THREAD: 5/8-11



NO: RB01700A

4 1/2

VOLTAGE / RATING: 120V AC/DC
AMPÉRAGE / AMPERAGE: 7.0
GRANDEUR DE LA MEULE / WHEEL SIZE : 4 1/2
**PUISSANCE MAX. DE L'OUTIL/
MAX. TOOL HORSEPOWER: 1.1**
ARBRE / SPINDLE THREAD: 5/8-11



NO: RB01701A

5"

VOLTAGE / RATING: 120V AC/DC
AMPÉRAGE / AMPERAGE: 9.0
GRANDEUR DE LA MEULE / WHEEL SIZE : 5
**PUISSANCE MAX. DE L'OUTIL/
MAX. TOOL HORSEPOWER: 1.3**
ARBRE / SPINDLE THREAD: 5/8-11



NO: RB1703AE

5"

VOLTAGE / RATING: 120V AC/DC
AMPÉRAGE / AMPERAGE: 8.5
GRANDEUR DE LA MEULE / WHEEL SIZE: 5"
**PUISSANCE MAX. DE L'OUTIL/
MAX. TOOL HORSEPOWER: 1.8**
ARBRE / SPINDLE THREAD: 5/8-11



BOSCH

RECTIFIEUSES À ANGLE DROIT / RIGHT ANGLE GRINDERS

NO: RB1752G7

7"

VOLTAGE / RATING: 120V AC/DC

AMPÉRAGE / AMPERAGE: 15.0 A

GRANDEUR DE LA MEULE / WHEEL SIZE: 7"

PUISSANCE MAX. DE L'OUTIL/

MAX. TOOL HORSEPOWER : 3.0

ARBRE /SPINDLE THREAD: 5/8-11

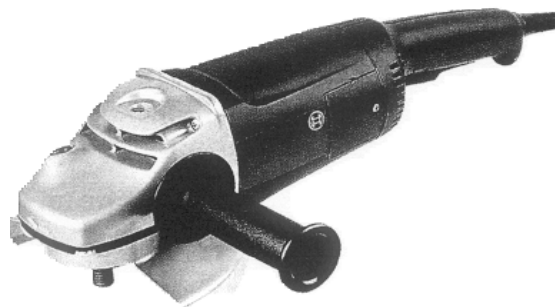

NO: RB1754G7

7"

VOLTAGE / RATING: 120V AC/DC

AMPÉRAGE / AMPERAGE: 15.0 A

GRANDEUR DE LA MEULE/ WHEEL SIZE: 7"

PUISSANCE MAX. DE L'OUTIL/

MAX. TOOL HORSEPOWER : 4.5

ARBRE /SPINDLE THREAD: 5/8-11

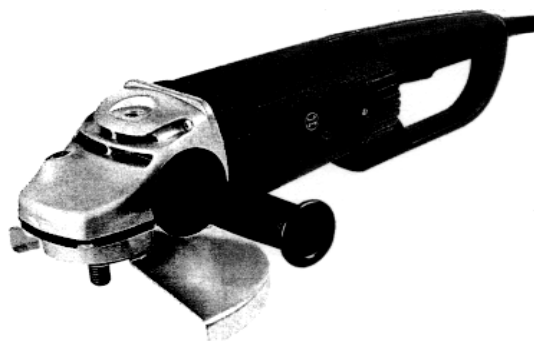

NO: RB01347A

4 1/2"

VOLTAGE / RATING: 120V AC/DC

AMPÉRAGE / AMPERAGE: 6.0 A

GRANDEUR DE LA MEULE/

WHEEL SIZE: 4 1/2"

PUISSANCE MAX. DE L'OUTIL/

MAX. TOOL HORSEPOWER : 1.0

ARBRE /SPINDLE THREAD: 5/8-11

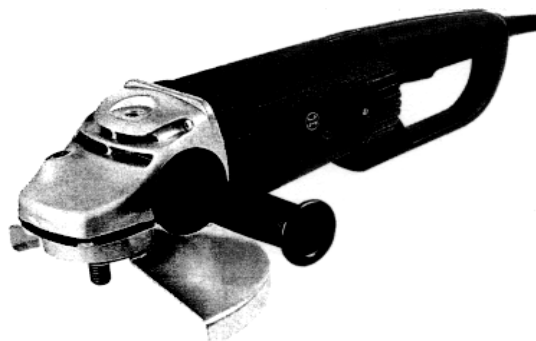

Tel.: (819) 346-2903 / (888) 345-2903 Fax.: (819) 346-3389

Email: distributeur@boulonsestrie.com

BOSCH

ENSEMBLE PERCEUSE AVEC COFFRE / DRILL KIT

NO: RB1005VS

3/8"

(AVEC COFFRE / WITH CASE)

VOLTAGE / RATING: 120V AC

AMPÉRAGE / AMPERAGE : 5.5

CAP. MAXIMUM / MAX CAPACITY:

POUR BOIS/FOR WOOD(FLAT SPADE BIT):1"

POUR ALUMINIUM/FOR ALUMINUM: 3/8"

POUR ACIER/FOR STEEL: 3/8"

0-2500 RPM



PERCEUSE FORCE INTENSE 1/2" / HIGH TORQUE HEAVY DUTY DRILL/ 1/2" DRIVE

NO: RB1034VS

1/2"

VOLTAGE / RATING : 120 V AC

AMPÉRAGE / AMPERAGE : 8.0

RPM 0-550



BOSCH-BOSCH-BOSCH



Tel.: (819) 346-2903 / (888) 345-2903 Fax.: (819) 346-3389

Email: distributeur@boulonsestrie.com

BOSCH

ENSEMBLES PERCEUSE À BATTERIE AVEC COFFRE / VOLT DRILL DRIVER KITS

NO: RB03315K

12 V

VOLTAGE / RATING: 12V DC

CAPACITÉ DE LA BATTERIE /

BATTERY CAPACITY: 1.7 A-h

MANDRIN / CHUCK CAPACITY: 3/8"

INCLUANT / UNCLUDE : 2 BATTERIES, CASE, BIT #2 PHILLIPS



NO: RB03615K

14.4 V

VOLTAGE / RATING: 14.4V DC

CAPACITÉ DE LA BATTERIE /

BATTERY CAPACITY: 1.7 A-h

MANDRIN / CHUCK CAPACITY : 3/8"

INCLUANT / INCLUDE : 2 BATTERIES, CASE, BIT #2 PHILLIPS

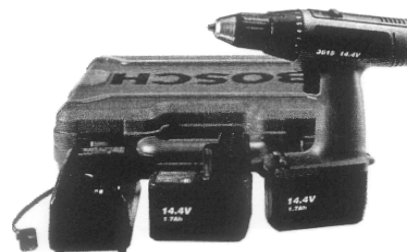

NO: RB03650K

14.4 V

VOLTAGE / RATING: 14.4V DC

CAPACITÉ DE LA BATTERIE /

BATTERY CAPACITY: 2.0 A-h

MANDRIN / CHUCK CAPACITY: 1/2"

INCLUANT / INCLUDE : 2 BATTERIES, CASE, BIT #2 PHILLIPS

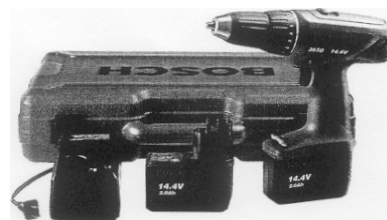

NO: RB03655K

14.4 V

VOLTAGE / RATING: 14.4V DC

CAPACITÉ DE LA BATTERIE /

BATTERY CAPACITY: 2.0 A-h

MANDRIN / CHUCK CAPACITY: 1/2"

INCLUANT / INCLUDE : 2 BATTERIES, CASE, BIT #2 PHILLIPS

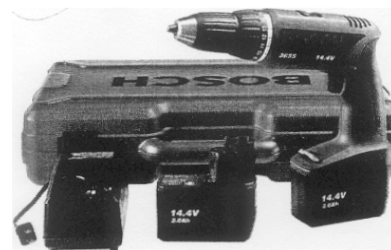

BOSCH

ENSEMBLE PERCEUSE À BATTERIE AVEC COFFRE / VOLT DRILL DRIVER KIT

NO: RB03860K

18 V

VOLTAGE / RATING: 18 V DC

CAPACITÉ DE LA BATTERIE /

BATTERY CAPACITY: 2.0 A-h

MANDRIN / CHUCK CAPACITY: 1/2"

INCLUANT / INCLUDE : 2 BATTERIES, CASE, BIT #2 PHILLIPS



PERCEUSES MARTEAU(S.D.S) / S.D.S. HAMMER DRILLS

NO: RB11224V

7/8"

VOLTAGE / RATING: 120V AC

AMPÉRAGE / AMPERAGE: 6.9

CAP. MAXIMUM/MAX CAPACITY:

POUR BOIS/FOR WOOD: 1"

POUR BÉTON/FOR CONCRETE: 7/8"

POUR ACIER/FOR STEEL: 1/2"



NO: RB11234V

3/4"

RATING / VOLTAGE : 120V AC

AMPÉRAGE / AMPERAGE : 4.4

CAP. MAXIMUM / MAX CAPACITY:

POUR BOIS/FOR WOOD: 3/4"

POUR BÉTON/FOR CONCRETE: 3/4"

POUR ACIER/FOR STEEL: 1/2"



BOSCH-BOSCH-BOSCH

BOSCH

PERCEUSE MARTEAU /
HAMMER DRILL

NO: RB1194VS

VOLTAGE / RATING : 120V AC

AMPÉRAGE / AMPERAGE: 8.0

CAPACITÉ MAX. / MAX. CAPACITIES:

POUR ALUMINIUM/FOR ALUMINUM:

5/8" (FAIBLE,LOW) & 3/8" (GRANDE,HIGH)

POUR BÉTON/FOR CONCRETE:

3/4" (FAIBLE,LOW) & 3/8" (GRANDE,HIGH)

POUR ACIER/FOR STEEL:

1/2" (FAIBLE,LOW) & 1/4" (FAIBLE,LOW)



NO: RB1194VK -> KIT PERCEUSE À MARTEAU AVEC CASE

BOSCH-BOSCH-BOSCH

SCIE SAUTEUSE AVEC COFFRE /
JIGSAW KIT

NO: RB1584AN

(AVEC COFFRE / WITH KIT)

VOLTAGE / RATING: 120V AC

AMPÉRAGE / AMPERAGE: 5.0

LONGUEUR DE BRAS / STROKE LENGTH : 1"

BOIS/WOOD: 3 3/8"

PLASTIQUE/PLASTIC: 1 1/4"

ALUMINIUM/ALUMINIUM: 3/4"

ACIER MOYEN/MILD STEEL: 3/8"

ACIER INOXIDABLE/STAINLESS STEEL: 1/8"



Tel.: (819) 346-2903 / (888) 345-2903 Fax.: (819) 346-3389

Email: distributeur@boulonsestrie.com

BOSCH

PERCEUSE À ANGLE DROIT/
RIGHT ANGLE DRILL

NO: RB1132VS

VOLTAGE / RATING: 120V AC
AMPÉRAGE / AMPERAGE: 3.8
CAPACITÉ MAX./MAX. CAPACITIES:
POUR BOIS/FOR WOOD: 1"
POUR ALUMINUM/FOR ALUMINUM: 1/2"
POUR ACIER/FOR STEEL: 3/8"



BOSCH-BOSCH-BOSCH

SCIE ALTERNATIVE AVEC COFFRE /
RECIPROCATING SAW KIT

NO: RB1634VS

VOLTAGE / RATING: 120V AC
AMPÉRAGE / AMPERAGE: 10.5
LONGUEUR DE BRAS/
STROKE LENGHT: 1 1/4"
BOIS/WOOD: 9"
TUYAU/PIPE: 4 1/2"



FUSIL À AIR CHAUD /
HEAT GUN

NO: RB1943LE

VOLTAGE / RATING: 120V DC
AMPÉRAGE / AMPERAGE: 12.5
VOLUME D'AIR/AIR VOLUME: 8.8 -17.6 C.F.M
LONGUEUR/LENGTH: 10.5"



BOSCH

ENSEMBLE PERCEUSE À BATTERIE 24 VOLT AVEC COFFRE / 24 VOLT DRILL DRIVER KIT

NO: RB3960KC

VOLTAGE / RATING: 24V

CAPACITÉ DE BATTERIE/

BATTERY CAPACITY : 2.0 A-h

DIMENSION DE LA MÈCHE/

BIT SIZE : #2 PHILLIPS



INCLUS / INCLUDE :

1/2" PERCEUSE / DRILL / 1/2" DRIVE

2 BATTERIES PLATINUM / PLATINUM BATTERIES

CHARGEUR 1 HRE, MANCHE COTÉ / 1HOUR CHARGER, SIDE HANDLE

CLIC, SYSTÈME DE MÈCHES ET BOÎTIER / CLIC-CHANGE, BIT SYSTEM AND CASE

ACCESSOIRES / ACCESSORIES

NO: RBBAT015

PILE /BATTERY

14.4 VOLT

2.0 AH

NO: RBBAT018

PILE /BATTERY

18 VOLT

2.0 AH

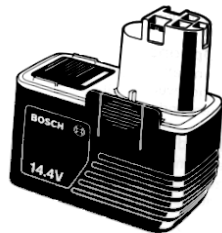

NO: RBBAT030

PILE/BATTERY

24 VOLT

2.0 AH

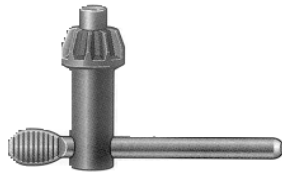
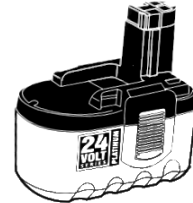

CLÉS MANCHE "T"

CHUCK KEYS

NOTRE CODE	DIA. GOUPILLE
OUR CODE	PIN DIA.
QW0000K1	5/32
QW0000K2	1/4
QW0000K3	5/16
QW0000K4	3/8

PINCES À JOINT ARTICULÉ



SLIP JOINT GRIPS

NOTRE CODE	LONGUEUR
OUR CODE	LENGTH
OU730401	6"
OU730402	8"
OU730403	10"

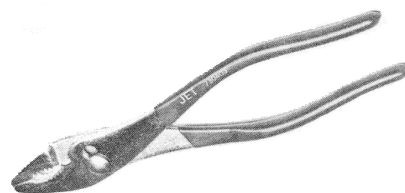

PINCES COULISSANTES

GROOVE JOINT GRIPS

NOTRE CODE	LONGUEUR
OUR CODE	LENGTH
OU730442	9 1/2 "
OU730443	12"



PINCES À LONG BEC

LONG NOSE GRIPS

NOTRE CODE	LONGUEUR
OUR CODE	LENGTH
OU730423	6 1/2 "
OU730425	8 "

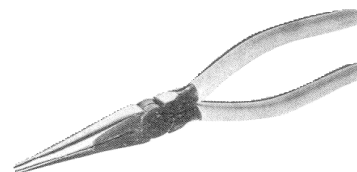

PINCES À LONG BEC COUDÉ

LONG NOSE GRIPS

NOTRE CODE	LONGUEUR
OUR CODE	LENGTH
OU730483	6 "
OU730485	8 1/2 "

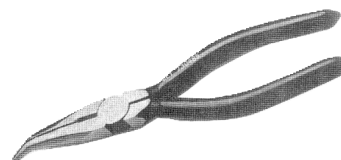

PINCES D'ÉLECTRICIEN

LINE MAN PLIERS

NOTRE CODE	LONGUEUR
OUR CODE	LENGTH
OU730414	7 "
OU730415	8 "

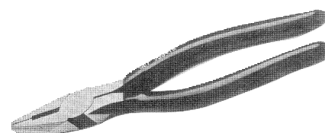

Tel.: (819) 346-2903 / (888) 345-2903 Fax.: (819) 346-3389

Email: distributeur@boulonsestrie.com

PINCES COUPE DIAGONAL



DIAGONAL CUT GRIPS

NOTRE CODE	LONGUEUR
OUR CODE	LENGTH
OU430433	6 1/2 "
OU430435	7 1/2 "

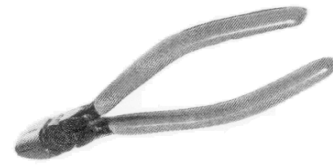

PINCES À LONG BEC

LONG NOSE PLIERS

NOTRE CODE	LONGUEUR
OUR CODE	LENGTH
OU430428	11 "
OU430488	11" COUDÉ / BENT NOSE



PINCES À LONG BEC

LONG NOSE GRIPS

WISE GRIP

WISE GRIP

NOTRE CODE	LONGUEUR
OUR CODE	LENGTH
OU730463	6 "
OU730467	9 "

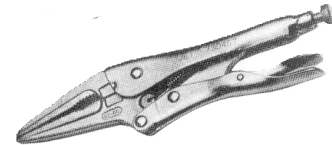

PINCE À TÔLE

SHEET METAL LOK CLAMP

NOTRE CODE	LONGUEUR
OUR CODE	LENGTH
OU730551	8"



AUSSI DISPONIBLE / ALSO AVAILABLE:

PINCE DE SOUDEUR 9" / WELDER LOCK CLAMP 9"



Tel.: (819) 346-2903 / (888) 345-2903 Fax.: (819) 346-3389

Email: distributeur@boulonsestrie.com

PINCE ÉTAU DROITE / STRAIGHT LOCKING PLIER

NOTRE CODE	LONGUEUR
OUR CODE	LENGTH
*****	5"



PINCE ÉTAU LONG BEC / LONG NOSE LOCKING PLIER

NOTRE CODE	LONGUEUR
OUR CODE	LENGTH
OUVG06LN	6"



PINCE ÉTAU DROITE / STRAIGHT LOCKING PLIER

NOTRE CODE	LONGUEUR
OUR CODE	LENGTH
OUVG07WR	7"



PINCE ÉTAU DROITE / STRAIGHT LOCKING PLIER

NOTRE CODE	LONGUEUR
OUR CODE	LENGTH
OUVG10WR	10"



PINCE ÉTAU POUR SOUDURE / WELDING LOCKING PLIER

NOTRE CODE	LONGUEUR
OUR CODE	LENGTH
OUVG009R	9"



PINCE ÉTAU EN "C" / "C" CLAMP LOCKING PLIER

NOTRE CODE	LONGUEUR
OUR CODE	LENGTH
OUVGG11R	11"

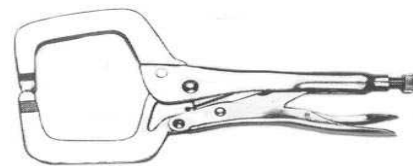

PINCE ÉTAU PRISE "L" / "L" SHAPE LOCKING PLIER

NOTRE CODE	LONGUEUR
OUR CODE	LENGTH
*****	0" à / to 6 1/2"

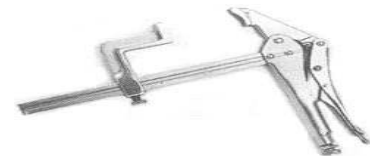

Tel.: (819) 346-2903 / (888) 345-2903 Fax.: (819) 346-3389

Email: distributeur@boulonsestrie.com

CISAILLES TYPE AVIATION

AVIATION SNIPS

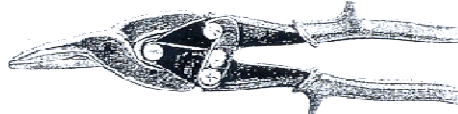

**COUPE À GAUCHE
LEFT CUT**

NO: OU690210

ROUGE

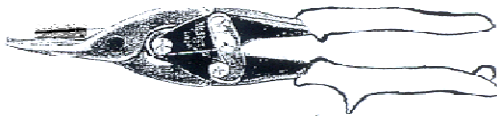

**COUPE DROITE
STRAIGHT CUT**

NO: OU690230

JAUNE

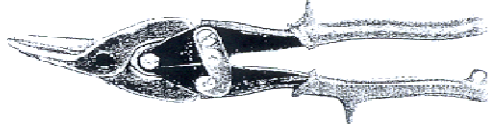

**COUPE À DROITE
RIGHT CUT**

NO: OU690220

VERT

CISAILLES DE FERBLANTIER

STRAIGHT PATTERN SNIPS

NOTRE CODE	DESCRIPTION
OUR CODE	DESCRIPTION
*****	8"
*****	10"
OU690312	12"

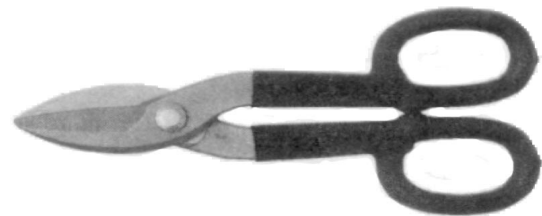

CLÉS À MOLLETTE STANDARD

AJUSTABLE WRENCH

NOTRE CODE	DESCRIPTION
OUR CODE	DESCRIPTION
QW000006	6" X 3/4 OUVERTURE
QW000008	8" X 1 OUVERTURE
QW000010	10" X 1 1/4 OUVERTURE
QW000012	12" X 1 3/8 OUVERTURE
*****	15" X 1 3/4 OUVERTURE
QW000018	18" X 2 1/8 OUVERTURE
*****	24" X 2 1/2 OUVERTURE



***** JEUX DE CLÉS VOIR O-15 / KEY SETS SEE O-15 *****



Tel.: (819) 346-2903 / (888) 345-2903 Fax.: (819) 346-3389

Email: distributeur@boulonsestrie.com

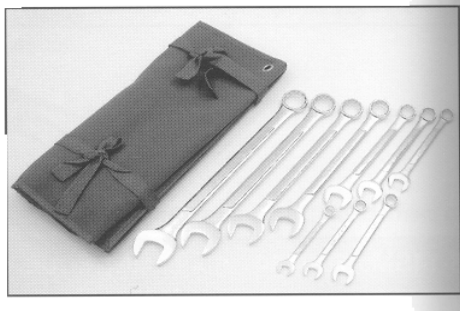

OU700115

JEU DE CLÉS O/F 3/8 À 1 S.A.E
KEY SET O/F 3/8 À 1 S.A.E



OU700167

JEU DE CLÉS O/F M8 À M19 MÉTRIQUE
KEY SET O/F M8 À M19 METRIC

PINCE "CHANNEL LOCK" 12" / UTILITY - PIPE PLIERS
NO PRODUIT: OU648012 (10" DISPONIBLE/AVAILABLE)



MARTEAUX

PINCE À CLÔTURE / FENCE PLIERS
NO PRODUIT: OU648015



HAMMERS

NOTRE CODE	DESCRIPTION
OUR CODE	DESCRIPTION
OU648085	"BEAM CLAW" 16 OZ
*****	"BEAM RIPPING" 16 OZ

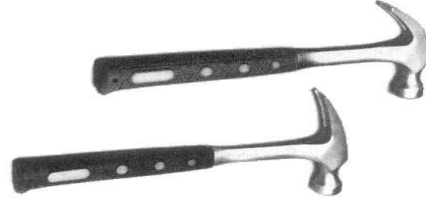

BARRES À CLOUS



WRECKING BARS

NOTRE CODE	DESCRIPTION
OUR CODE	DESCRIPTION
*****	1/2 X 12"
OU058180	5/8 X 18"
OU034240	3/4 X 24"
OU034300	3/4 X 30"
*****	3/4 X 36"

AUSSI DISPONIBLE / ALSO AVAILABLE
BARRES DE LEVAGE PRY BARS

DIFFÉRENTS MODÈLES DISPONIBLES
MANY STYLES AVAILABLE



Tel.: (819) 346-2903 / (888) 345-2903 Fax.: (819) 346-3389

Email: distributeur@boulonsestrie.com

BURINS PLAT

FLAT CHISELS

NOTRE CODE	TAILLE PO.	TIGE PO.	LONG.PO.
OUR CODE	CUT IN.	BODY IN.	LENGTH IN.
*****	1/4	3/16	4 1/2
*****	5/16	1/4	5
*****	3/8	1/4	5 1/4
OU000C2	1/2	3/8	5 1/2
*****	5/8	1/2	6
OU000C4	3/4	5/8	6 1/2
*****	7/8	3/4	7 1/2
OU000C6	1	7/8	7 3/4
*****	1 1/8	1	8 1/2



POINÇONS CHASSE-GOUPILLE

PIN PUNCHES

NOTRE CODE	POINTE PO.	TIGE PO.	LONG.PO.
OUR CODE	PIN DIA IN.	BODY IN.	LENGTH IN.
*****	1/16	1/4	4
*****	3/32	5/16	4 3/4
OU000C28	1/8	5/16	4 3/4
*****	5/32	5/16	5
OU000C29	3/16	3/8	5 1/4
*****	7/32	3/8	6
OU000C30	1/4	3/8	6 1/4
OU000C31	5/16	7/16	6 1/2
OU00C31A	3/8	5/8	8
OU00C31B	7/16	3/4	10
OU00C31C	1/2	3/4	10



POINÇONS À CENTRER

CENTRE PUNCHES

NOTRE CODE	POINTE PO.	TIGE PO.	LONG.PO.
OUR CODE	PIN DIA IN.	BODY IN.	LENGTH IN.
*****	3/32	1/4	4
*****	1/8	5/16	5
OU000C34	1/8	3/8	5 1/4
*****	3/16	1/2	6
OU00C35A	3/16	1/2	7



AUSSI DISPONIBLE / ALSO AVAILABLE

**ENS. DE CISEAUX & POINÇONS /
PUNCH & CHISEL SETS**

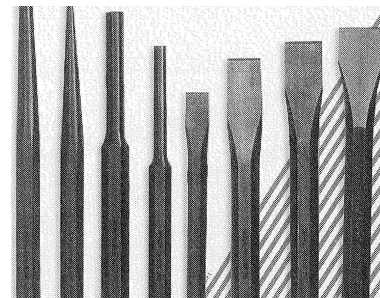

***CONCEPT EXTRA FORT / HEAVY DUTY CONSTRUCTION.

***LEVIER ET EMBOUTS FABRIQUÉS D'ACIER / VISE HEAD AND BODY MADE FROM GREY CAST IRON.

***LÈVRE DE MÂCHOIRES REMPLAÇABLES EN ACIER AU CARBONE / REPLACEABLE REINFORCED CARBON STEEL JAWS.

***AXE D'ACIER AU CARBONE RENFORCÉ / SPINDLE DEEP THROAT TO HANDLE LARGE MATERIALS.

***MÂCHOIRES ÉVIDÉES PERMETTANT LE SERRAGE DE GROS OBJETS/ EXTRA DEEP THROAT TO HANDLE LARGE MATERIALS.

NOTRE CODE	DESCRIPTION
OUR CODE	DESCRIPTION
OU647710	ÉTAU FIXE DE 3 po AVEC ENCLUME
OU647711	ÉTAU FIXE DE 4 po AVEC ENCLUME
OU647712	ÉTAU FIXE DE 5 po AVEC ENCLUME
OU647713	ÉTAU FIXE DE 6 po AVEC ENCLUME
OU647714	ÉTAU FIXE DE 8 po AVEC ENCLUME
OU647720	PLATEAU TOURNANT D'ÉTAU 3 po
OU647721	PLATEAU TOURNANT D'ÉTAU 4 po
OU647722	PLATEAU TOURNANT D'ÉTAU 5 po
OU647723	PLATEAU TOURNANT D'ÉTAU 6 po
OU647724	PLATEAU TOURNANT D'ÉTAU 8 po

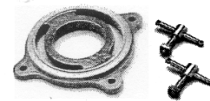
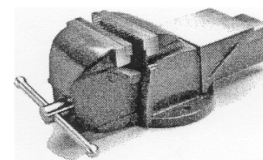

SERRES EN "C"

"C" CLAMPS

NOTRE CODE	DESCRIPTION
OUR CODE	DESCRIPTION
OU647791	2po - 800 kg
OU647792	3po - 1000 kg
OU647793	4po - 1300 kg
OU647794	5po - 1500 kg
OU647795	6po - 1800 kg
OU647796	8po - 2000 kg
OU647797	10po - 2500 kg
OU647798	12po - 2800 kg



OUTILS DE GRAISSAGE / GREASE GUNS TOOLS



**TUYAU DE 12 PO. FLEXIBLE
(18" DISPONIBLE) /
FLEXIBLE HOSE 12" (AVAILABLE 18")
*PRESSION / WORKING PRESSURE
AT 4500 PSI/
*1/8" X 27 NPT THREAD
N° OU638020**

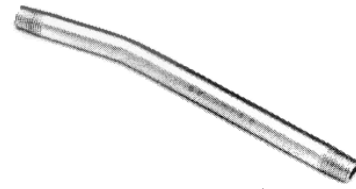

**TUYAU DE 5 PO. RIGIDE / 5" PIPE
*PIPE EN ACIER / METAL PIPE
*1/8" X 27 NPT THREAD
N° OU638015**



**PISTOLET À GRAISSER MINIATURE /
MINI GREASE GUN
N° OU638007**

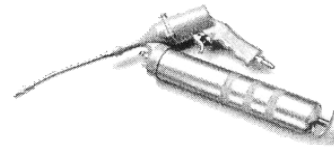

**FUSIL À GRAISSER PNEUM. 14 OZ. /
AIR OPERATED GREASE GUN
N° OU638005**

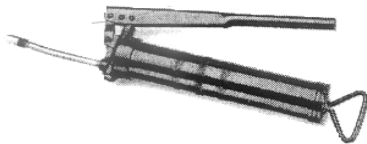

**FUSIL À GRAISSER 14 OZ. /
HAND LEVER TYPE GREASE GUN
*INCLU PIPE & RACCORD/
INC. PIPE & COUPLER
N° OU638010**

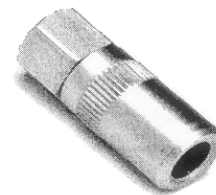

**MANCHON DE RACCORD
HYDRAULIQUE /
GREASE GUN COUPLER
* 1/8 X 27 NPT THREAD
N° OU638025**



Tel.: (819) 346-2903 / (888) 345-2903 Fax.: (819) 346-3389

Email: distributeur@boulonsestrie.com

HUILIERS

OILERS

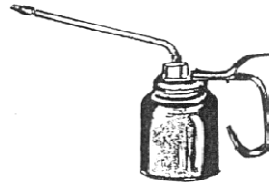

NOTRE CODE	DESCRIPTION	BEC	
OUR CODE	DESCRIPTION	SPOUT	
OU000033	6 OZ.	6 1/2	RIGIDE
OU000229	36 OZ.	12	COURBE
OU00028A	16 OZ.	9	RIGIDE
OU00028F	16 OZ.	9	FLEXIBLE
OU00029F	32 OZ.	9	FLEXIBLE
OU00033F	6 OZ.	6 1/2	FLEXIBLE

NOTRE CODE	DESCRIPTION
OUR CODE	DESCRIPTION
OU00028N	BEC DE RECHANGE POUR HUILIER NO 28F
OU00033N	BEC DE RECHANGE POUR HUILIER NO 33F

ENTONNOIR

FUNNEL



NOTRE CODE	DESCRIPTION
OUR CODE	DESCRIPTION
QF300900	PLASTIQUE / PLASTIC 9"



Tel.: (819) 346-2903 / (888) 345-2903 Fax.: (819) 346-3389
 Email: distributeur@boulonsestrie.com

TOURNEVIS À PRISE CARRÉE / SQUARE DRIVE SCREWDRIVERS

CODE	DESCRIPTION
TV000000	# 0 JAUNE / YELLOW
TV000001	# 1 JUNIOR VERT / GREEN
TV000002	# 2 JUNIOR ROUGE / RED
TV000003	# 3 JUNIOR NOIR / BLACK
TV000011	# 1 JUMBO VERT / GREEN
TV000012	# 2 JUMBO ROUGE / RED
TV000013	# 3 JUMBO NOIR / BLACK
TV000014	# 4 X 6 X 10 X 3/4

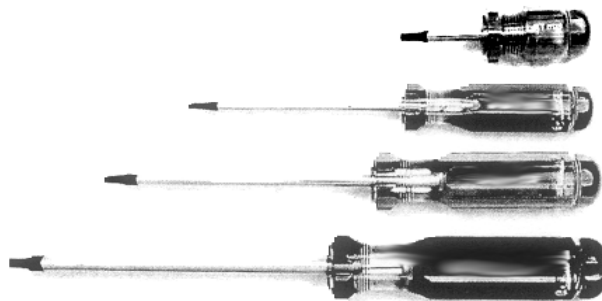

TOURNEVIS PRISE ÉTOILE / PHILLIPS DRIVE SCREWDRIVERS

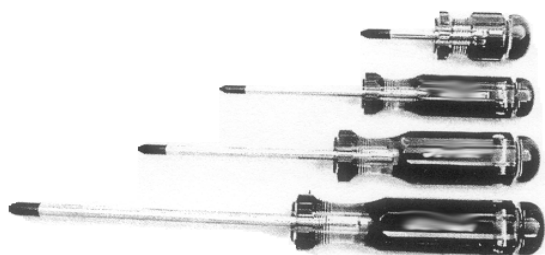

CODE	DESCRIPTION
TV720371	# 0 JAUNE / YELLOW
TV720372	# 1 JUNIOR VERT / GREEN
TV720373	# 2 JUNIOR ROUGE / RED
*****	# 3 JUNIOR NOIR / BLACK

TOURNEVIS PRISE PLATE POUR VIS À TÊTE FENDUE DISPONIBLE /
SLOT DRIVE SCREWDRIVERS AVAILABLE

TOURNEVIS MULTI-DOUILLES / MULTI BIT SCREWDRIVERS

CODE	DESCRIPTION
TV019752	MULTI-DOUILLES / BITS (12) X 6 3/8
TV019758	MULTI-DOUILLES / BITS (8) X 7 1/8



DOUILLES DISPONIBLES / BITS AVAILABLE



Tel.: (819) 346-2903 / (888) 345-2903 Fax.: (819) 346-3389

Email: distributeur@boulonsestrie.com

DOUILLES ÉTOILES PHILLIPS BITS	
	
NOTRE CODE	DESCRIPTION
OUR CODE	DESCRIPTION
BT101010	1 X 1
BT101020	1 X 2
BT101027	1 X 2 3/4
BT101040	1 X 4
BT101060	1 X 6
BT102010	2 X 1
BT102020	2 X 2
BT102030	2 X 3
BT102060	2 X 6
BT103010	3 X 1
BT103020	3 X 2
BT103030	3 X 3
BT103060	3 X 6

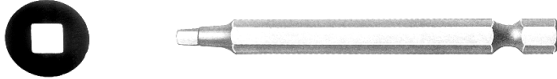
DOUILLES CARRÉES SQUARE BITS	
	
NOTRE CODE	DESCRIPTION
OUR CODE	DESCRIPTION
BT200010	0 X 1
BT200020	0 X 2
BT200030	0 X 3
BT201010	1 X 1
BT201020	1 X 2
BT201030	1 X 3
BT201040	1 X 4
BT201060	1 X 6
BT202010	2 X 1
BT202020	2 X 2
BT202030	2 X 3
BT202040	2 X 4
BT202060	2 X 6
BT203010	3 X 1
BT203020	3 X 2
BT203030	3 X 3
BT203040	3 X 4
BT203060	3 X 6

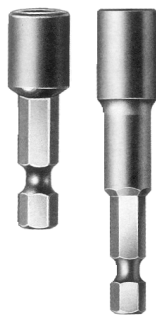

PRISES MAGNÉTIQUES MAGNETIC SOCKETS

NOTRE CODE	DESCRIPTION
OUR CODE	DESCRIPTION
SM000025	1/4 X 2 9/16
SM000031	5/16 X 2 9/16
SM000037	3/8 X 2 9/16
SM000043	7/16 X 2 9/16



Tel.: (819) 346-2903 / (888) 345-2903 Fax.: (819) 346-3389
 Email: distributeur@boulonsestrie.com

OUTILS DE MESURES

MEASURING TOOLS

RUBANS À MESURER

MEASURING TAPES

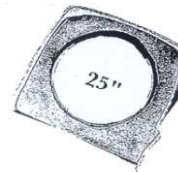
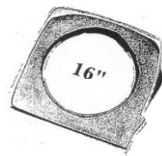

NOTRE CODE	DESCRIPTION	UNITÉ DE MESURE
OUR CODE	DESCRIPTION	UNIT OF MEASURE
OU160750	3/4" X 16	MÉTRIQUE & POUCE / METRIC & INCH
OU160751	3/4" X 16	POUCE / INCH
OU251000	1" X 25	MÉTRIQUE & POUCE / METRIC & INCH
OU251001	1" X 25	POUCE / INCH



OUTIL DE MESURE ÉLECTRONIQUE

DIGITAL GALIPER

NOTRE CODE	DESCRIPTION
OUR CODE	DESCRIPTION
OU648107	MESURE: 0-8" / IMPÉRIAL & MÉTRIQUE / PARTIE MÉC. EN ACIER INOX. RANGE: 0-8" / METRIC & IMPERIAL / MECHANICAL PARTS IN ST. STEEL

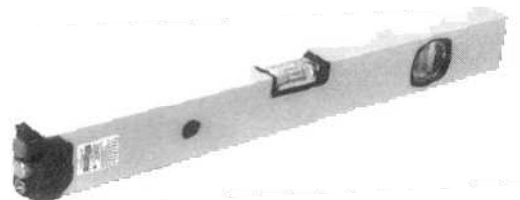

NIVEAU AU LASER

LASER LEVEL

NOTRE CODE	DESCRIPTION
OUR CODE	DESCRIPTION
OU648100	NIVEAU D'ÉLÉVATIONS 16" / BULLES HORIZONTALES & VERTICALES 16" LASER LEVEL / HIGH QUALITY HOR. & VERT. BUBBLE LEVELS.











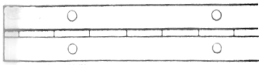
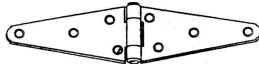
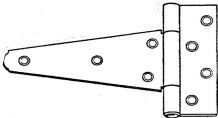

Tel.: (819) 346-2903 / (888) 345-2903 Fax.: (819) 346-3389

Email: distributeur@boulonstrie.com

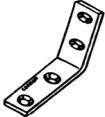
SECTION Q

QUINCAILLERIE DIVERSE / VARIOUS HARDWARE

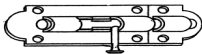
INFORMATION TECHNIQUE.....DÉBUT DE LA SECTION
TECHNICAL INFORMATION.....BEGINNING OF THIS SECTION

	DESCRIPTION	SECTION-PAGE
	PENTURES À PIANO. PIANO HINGES.	Q-6
	CHARNIÈRES À BATTANTS ROBUSTES. HEAVY STRAP HINGES.	Q-7
	CHARNIÈRES EN "T" ROBUSTES. HEAVY "T" HINGES.	Q-7
	CHARNIÈRES À RESSORT. SPRING HINGES.	SUR DEMANDE ON REQUEST
	CHARNIÈRES CARRÉES. BUTT HINGES.	SUR DEMANDE ON REQUEST
	PAUMELLES À SOUDER. WELD ON HINGES.	SUR DEMANDE ON REQUEST
	ÉQUERRES EN ACIER. STEEL CORNER BRACES.	Q-8
	SUPPORTS DE TABLETTE. SHELF BRACKETS.	Q-8
	CROCHETS À MANTEAU. COAT HOOKS.	Q-9
	MORILLONS ROBUSTES. HEAVY DUTY HASPS.	Q-9
	VERROUS À PÊNE ROND. BARREL BOLTS.	Q-9
	EMBOUTS DE CANNE. CRUTCH TIPS.	Q-9

SECTION Q

QUINCAILLERIE DIVERSE / VARIOUS HARDWARE

	DESCRIPTION	SECTION-PAGE
	CADENAS LAITON MASSIF. SOLID PADLOCK BRASS.	Q-10
	COLLIERS DE SERRAGE. HOSE CLAMPS.	Q-11
	ATTACHES AUTOBLOCANTES. TIE-WRAPPS.	Q-13
	SANGLES EN CAOUTCHOUC AVEC CROCHETS. HEAVY DUTY RUBBER STRAPS WITH HOOKS.	Q-13
	CORDE DE POLYPROPYLENE. POLYPROPYLENE ROPE.	Q-14
	FICELLE ET CÂBLES. TWIN AND ROPE.	
	FEUILLES POUR CALE LAITON. BRASS SHIM STOCK.	Q-15
	BATTERIES & LAMPES DE POCHE. INDUSTRIAL BATTERIES & FLASHLIGHTS.	Q-16
	ROUES. CASTERS.	Q-17



CROCHETS DE GARDE-ROBE ASSORTED COAT & HAT HOOKS

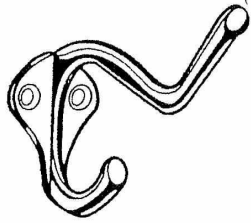

6206

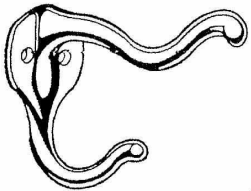

6210

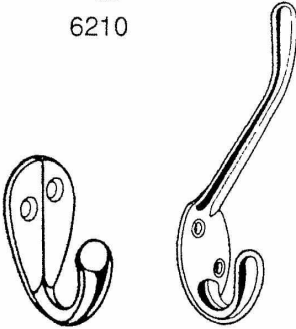

6212

6211

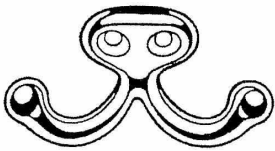

6213

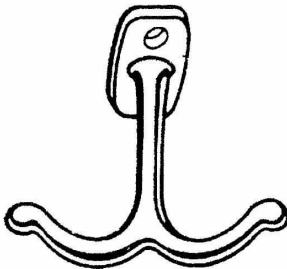

6215

BUTOIRS DOORS STOPS

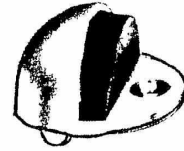

T200

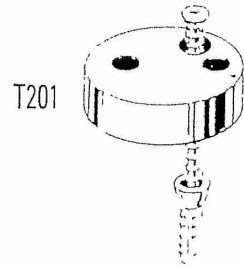

T201

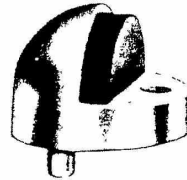

T218



T233



T231



64 BU

805**

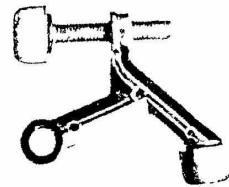

615

**PENTURES À PIANO /
PIANO HINGES**

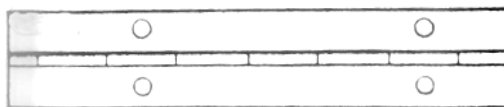

NOIR (SANS TROU / NO HOLES) BARE

NOTRE CODE	LARGEUR OUVERTE	ÉPAISSEUR	LONGUEUR	DIA. TIGE
OUR CODE	OPEN WIDTH	THICKNESS	LENGTH	PIN DIA.
QP010106	1 1/16	0.040	72"	3/32
QP010150	1 1/2	0.060	72"	9/64
QP012000	2	0.060	72"	9/64
QP013000	3	0.062	72"	1/8
QP014000	4	0.125	72"	3/8

ZINC PLATED

NOTRE CODE	LARGEUR OUVERTE	ÉPAISSEUR	LONGUEUR	DIA. TIGE
OUR CODE	OPEN WIDTH	THICKNESS	LENGTH	PIN DIA.
QP020106	1 1/16	0.025	72"	****
QP020125	1 1/4	0.030	72"	1/16
QP020150	1 1/2	0.040	72"	3/32
QP022000	2	0.039	72"	3/32

ACIER INOXYDABLE (SANS TROU / NO HOLES) STAINLESS STEEL

NOTRE CODE	LARGEUR OUVERTE	ÉPAISSEUR	LONGUEUR	DIA. TIGE
OUR CODE	OPEN WIDTH	THICKNESS	LENGTH	PIN DIA.
QP030106	1 1/16	0.037	72"	1/8
QP030125	1 1/4	0.060	72"	1/8
QP030150	1 1/2	0.060	72"	1/8
QP032000	2	0.062	72"	9/64
QP033000	3	0.075	72"	1/4

LAITON BRASS

NOTRE CODE	LARGEUR OUVERTE	ÉPAISSEUR	LONGUEUR	DIA. TIGE
OUR CODE	OPEN WIDTH	THICKNESS	LENGTH	PIN DIA.
QP040125	1 1/4	0.030	72"	***
QP040150	1 1/2	0.043	72"	5/64
QP042000	2	0.045	72"	5/64

AUTRES DIMENSIONS DISPONIBLES / OTHER DIMENSIONS ARE AVAILABLE



Tel.: (819) 346-2903 / (888) 345-2903 Fax.: (819) 346-3389

Email: distributeur@boulonsestrie.com

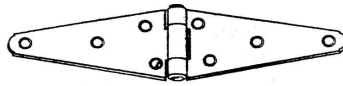

ZINC / PLATED

NOTRE CODE	DIMENSION(L)	H	ÉPAISSEUR
OUR CODE	DIMENSION(L)	H	THICKNESS
QP921CXB	4"	1-3/4"	0.09"
QP922CXB	6"	2-3/8"	0.09"
QP923CXB	8"	3-1/8"	0.10"
QP924CXB	10"	3-1/8"	0.11"
*****	12"	3-1/2"	0.11"

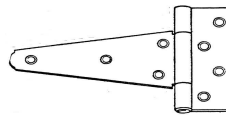

ZINC / PLATED

NOTRE CODE	DIMENSION(L)	P	H	ÉPAISSEUR
OUR CODE	DIMENSION(L)	P	H	THICKNESS
QP925CXB	4"	1-3/16"	3-3/8"	0.09"
QP926CXB	6"	1-3/4"	4-1/2"	0.10"
QP927CXB	8"	2"	5-5/8"	0.10"
QP928CXB	10"	2-1/8"	6"	0.11"
QP929X-B	12"	2-1/8"	6"	0.11"

SUR DEMANDE / ON REQUEST

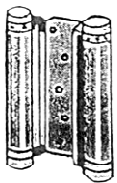

CHARNIÈRES À RESSORT
SPRING HINGES

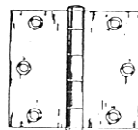

CHARNIÈRES CARRÉES, FICHE AMOVIBLE, EMBOUTIE
BROAD BUTT HINGES, SWAGED LOOSE PIN

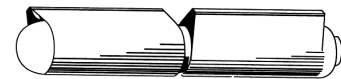

PAUMELLES À SOUDER
WELD ON HINGES

AUTRES MODÈLES DE CHARNIÈRES SONT DISPONIBLES SUR DEMANDE /
OTHER KINDS OF HINGES ARE AVAILABLE ON REQUEST



Tel.: (819) 346-2903 / (888) 345-2903 Fax.: (819) 346-3389

Email: distributeur@boulonsestrie.com

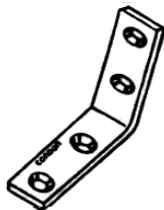

NOTRE CODE	DIMENSION (L) PO	LARGEUR	QTÉ/BTE
OUR CODE	DIMENSION (L) IN	WIDTH	QTY/BOX
SPÉCIAL / SPECIAL			
EA075075	3/4 X 3/4	3/4	100
EP320075	3/4 X 3/4	1/2	20
EP320100	1 X 1	1/2	20
EP320150	1 1/2 X 1 1/2	1/2	20
EP320200	2 X 2	5/8	20
EP320250	2 1/2 X 2 1/2	5/8	20
EP320300	3 X 3	3/4	20
EP320400	4 X 4	7/8	10
EP320500	5 X 5	1	10
EP320600	6 X 6	1 1/8	10
EP320800	8 X 8	1 1/8	10

SUPPORTS DE TABLETTE

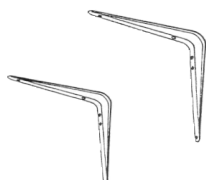

SHELF BRACKETS

NOTRE CODE	DIMENSION (PO)	QTÉ/BTE
OUR CODE	DIMENSION (IN)	QTY/BOX
*****	3 X 4	20
*****	4 X 5	20
*****	5 X 6	20
326-0068	6 X 8	20
326-0709	7 X 9	20
326-0810	8 X 10	20
326-1012	10 X 12	20
326-1214	12 X 14	20



Tel.: (819) 346-2903 / (888) 345-2903 Fax.: (819) 346-3389

Email: distributeur@boulonsestrie.com



NOTRE CODE	HAUTEUR X PROFONDEUR (PO)	MATÉRIEL
OUR CODE	HIGH X DEEP (IN)	MATERIAL
QM006211	3 1/2 X 2	ZINC
QM006212	1 1/2 X 1 1/4	ZINC
QM006280	4 1/2 X 3 1/4	ZINC

MORAILLONS ROBUSTES

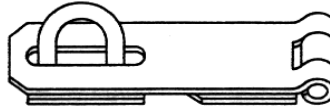

HEAVY DUTY HASPS

NOTRE CODE	DESCRIPTION (L) (PO)	MATÉRIEL
OUR CODE	DESCRIPTION (L) (IN)	MATERIAL
QR061725	2 5/8	ZINC
QR061735	3 1/2	ZINC
QR061745	4 1/2	ZINC
QR066176	6	ZINC

VERROUS À PÊNE ROND

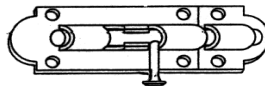

BARREL BOLTS

NOTRE CODE	DESCRIPTION (L) (PO)	MATÉRIEL
OUR CODE	DESCRIPTION (L) (IN)	MATERIAL
QBB00002	2 1/2	ZINC
QBB00003	3	ZINC
QBB00004	4	ZINC
QBB00006	6	ZINC
QBB00008	8	ZINC
QBB00045	4	LAITON /BRASS

EMBOUS DE CANNE



CRUTCH TIPS

NOTRE CODE	DIMENSION (PO)	MATÉRIEL
OUR CODE	DIMENSION (PO)	MATERIAL
QT000750	3/4	NOIR
QT000875	7/8	NOIR
QT001000	1	NOIR

SÉRIE 600
 ANSE À VERROUILLAGE SIMPLE / SINGLE LOCKING SHACKLE

NOTRE CODE	DESCRIPTION
OUR CODE	DESCRIPTION
QC631010	3/4
QC632010	1

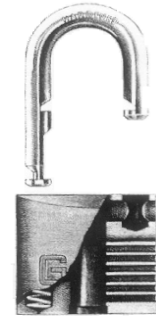

SÉRIE 800
 ANSE À VERROUILLAGE DOUBLE / DOUBLE LOCKING SHACKLE

NOTRE CODE	DESCRIPTION
OUR CODE	DESCRIPTION
QC833012	1 1/4
QC834015	1 1/2
QC834016	1 1/2 L
QC835017	1 3/4
*****	1 3/4 L
QC836020	2
QC836025	2 L

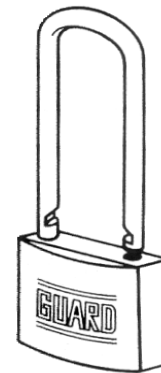

SÉRIES 600 & 800 - LAITON MASSIF

- * Technique de précision, service intense.
- * Evalué, approuvé et recommandé par les professionnels du métier dans le monde entier pendant plus de 50 ans.
- * Boîtier et barillet en laiton massif.
- * Anse en acier trempé
- * Goupilles anti-crochetage / antirouille
- * Ressorts en acier inoxydable.
- * Versions disponibles:
 KA(Clé semblable) -
 KD(Clé différente)

...

SOLID BRASS - SERIES 600 & 800

- * Precision engineered, heavy duty.
- * Time tested, approved and recommended by Industry Professionals around the world for more than 50 years.
- * Solid Brass case and plug.
- * Hardened Steel Shackle.
- * Rustproof anti-pick "mushroom" springs pin SS
- * Available Version:
 KA(Keyed alike)
 KD(Keyed Different)

...

ZINC(SEULEMENT LE BOULON EST
EN ACIER INOX)**PLATED**

(ONLY SCREW IN SS)

NOTRE CODE	DESCRIPTION	# GLOBAL	EQUIV. TRIDON	QTÉ/BTE
OUR CODE	DESCRIPTION	# GLOBAL	EQUIV. TRIDON	QTY/BOX
HS000004	1/4 A 5/8	HF4	MH4	10
HS000006	5/16 A 7/8	HF5	MH6	10
HS000007	3/8 A 25/32	HF6	HS6	10
HS000008	1/2 A 1	HF8	HS8	10
HS000010	9/16 A 1 1/8	HF10	HS10	10
HS000012	11/16 A 1 1/4	HF12	HS12	10
HS000016	5/8 A 1 1/2	HF16	HS16	10
HS000020	13/16 A 1 1/4	HF20	HS20	10
HS000024	1 1/16 A 2	HF24	HS24	10
HS000028	1 7/16 A 2 3/8	HF28	HS28	10
HS000032	1 9/16 A 2 1/2	HF32	HS32	10
HS000036	1 13/16 A 2 3/4	HF36	HS36	10
HS000040	2 1/16 A 3	HF40	HS40	10
HS000044	2 5/16 A 3 1/4	HF44	HS44	10
HS000048	2 9/16 A 3 1/2	HF48	HS48	10
HS000052	2 13/16 A 3 3/4	HF52	HS52	10
HS000054	3 A 3 13/16	HF54	HS54	10
HS000056	3 A 4	HF56	HS56	10
HS000060	3 5/16 A 4 1/4	HF60	HS60	10
HS000064	3 9/16 A 4 1/2	HF64	HS64	10
HS000072	4 1/8 A 5	HF72	HS72	10
HS000080	4 5/8 A 5 1/2	HF80	HS80	10
HS000084	4 3/8 A 5 11/16	HF84	HS84	10
HS000088	5 1/8 A 6	HF88	HS88	10
HS000096	5 5/8 A 6 1/2	HF96	HS96	10
HS000104	6 1/8 A 7	HF104	HS104	10
HS000116	6 7/8 A 7 3/4	HF116	HS116	10
HS000120	6 5/8 A 7 7/8	HF120	HS120	10
HS000124	6 7/8 A 8 1/4	HF124	HS124	10
HS000128	7 5/8 A 8 1/2	HF128	HS128	10

Q-11

ACIER INOXYDABLE



STAINLESS STEEL



NOTRE CODE	DESCRIPTION	# GLOBAL	EQUIV. TRIDON	QTÉ/BTE
OUR CODE	DESCRIPTION	# GLOBAL	EQUIV. TRIDON	QTY/BOX
HS100004	1/4 A 5/8	HF4SS	MAH4	10
HS100006	5/16 A 7/8	HF5SS	MAH6	10
HS100008	1/2 A 1	HF8SS	HAS8	10
HS100010	9/16 A 1 1/8	HF10SS	HAS10	10
HS100012	11/16 A 1 1/4	HF12SS	HAS12	10
HS100016	5/8 A 1 1/2	HF16SS	HAS16	10
HS100020	13/16 A 1 1/4	HF20SS	HAS20	10
HS100024	1 1/16 A 2	HF24SS	HAS24	10
HS100028	1 7/16 A 2 3/8	HF28SS	HAS28	10
HS100032	1 9/16 A 2 1/2	HF32SS	HAS32	10
HS100036	1 13/16 A 2 3/4	HF36SS	HAS36	10
HS100040	2 1/16 A 3	HF40SS	HAS40	10
HS100044	2 5/16 A 3 1/4	HF44SS	HAS44	10
HS100048	2 9/16 A 3 1/2	HF48SS	HAS48	10
HS100052	2 13/16 A 3 3/4	HF52SS	HAS52	10
HS100054	3 A 3 13/16	HF54SS	HAS54	10
HS100056	3 A 4	HF56SS	HAS56	10
HS100060	3 5/16 A 4 1/4	HF60SS	HAS60	10
HS100064	3 9/16 A 4 1/2	HF64SS	HAS64	10
HS100072	4 1/16 A 5	HF72SS	HAS72	10
HS100080	4 5/8 A 5 1/2	HF80SS	HAS80	10
HS100084	4 3/8 A 5 11/16	HF84SS	HAS84	10
HS100088	5 1/8 A 6	HF88SS	HAS84	10
HS100096	5 5/8 A 6 1/2	HF96SS	HAS96	10
HS100104	6 1/8 A 7	HF104SS	HAS104	10
HS100116	6 7/8 A 7 3/4	HF116SS	HAS116	10
HS100120	6 5/8 A 7 7/8	HF120SS	HAS120	10
HS100124	6 7/8 A 8 1/4	HF124SS	HAS124	10
HS100128	7 5/8 A 8 1/2	HF128SS	HAS128	10



Tel.: (819) 346-2903 / (888) 345-2903 Fax.: (819) 346-3389

Email: distributeur@boulonstrie.com

Q-12

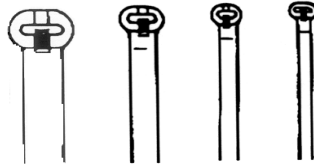

NYLON 6/6 (BLANC / WHITE)

NOTRE CODE	LARGEUR	LONGUEUR (PO)	RÉSISTANCE (LBS)
OUR CODE	WIDTH	LENGTH (IN)	STRENGHT(LBS)
TR000023	.091	3.62	18
TR000004	.140	5.50	18
TR000006	.140	11.10	40
TR000024	.184	7.31	50
TR000008	.184	14.10	50
TR000007	.270	13.40	120
TR005275	.270	18	120
TR000029	.301	30	120

NYLON 6/6 (NOIR/BLACK)

RÉSISTANT AUX RAYONS ULTRAVIOLETS ET AUX INTEMPÉRIES / UV & OUTDOOR AGING RESIST

NOTRE CODE	LARGEUR	LONGUEUR (PO)	RÉSISTANCE (LBS)
OUR CODE	WIDTH	LENGTH (IN)	STRENGHT(LBS)
TR000005	.140	5.50	18
TR000026	.140	11.10	40
TR000025	.184	7.31	50
TR000028	.184	14.20	50
TR000027	.270	13.40	120

AUTRES DIMENSIONS DISPONIBLES /OTHER DIMENSIONS ARE AVAILABLE

SANGLES EN CAOUTCHOUC
ROBUSTES AVEC CROCHETS

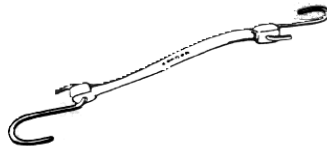

HEAVY DUTY RUBBER
TARP STRAPS WITH HOOKS

Fabriquée à l'épreuve
du craquement et
des intempéries.

NOTRE CODE	LONGUEUR (PO)
OUR CODE	LENGTH (IN)
TS090000	9
TS150000	15
TS200000	20
TS300000	31

Resists outdoor aging
and cracking.



Tel.: (819) 346-2903 / (888) 345-2903 Fax.: (819) 346-3389

Email: distributeur@boulonsestrie.com

JAUNE / YELLOW

NOTRE CODE	DIA X LENGHT
OUR CODE	DIA X LONGUEUR
QC000187	3/16 X 2125'
QC000250	1/4 X 1300'
QC000315	5/16 X 975'
QC000375	3/8 X 630'
QC000500	1/2 X 335'
QC000625	5/8 X 200'
QC000750	3/4 X 125'
QC001000	1 X 200'

3 TORONS / STRANDS

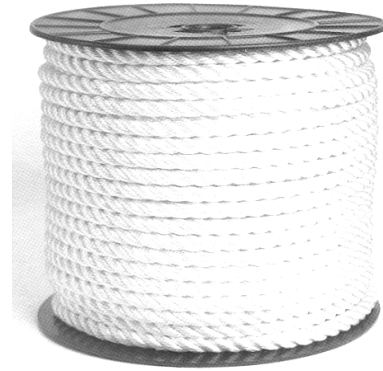

JAUNE / YELLOW

AUSSI DISPONIBLE / ALSO AVAILABLE

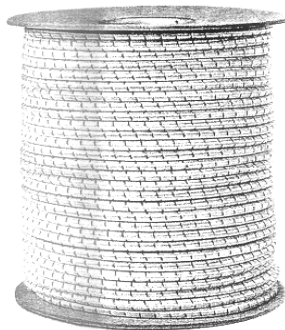

CORDE ÉLASTIQUE /
SHOCK CORD

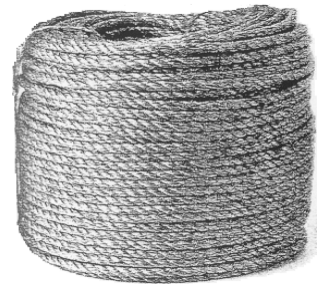

CABLE D'ARBORISTE /
ARBORIST ROPE



CÂBLE DE REMORQUAGE /
TOW ROPE



FICELLE DE PLASTIQUE /
PLASTIC TWINE

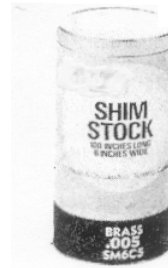

NOTRE CODE	ÉPAISSEUR	LARGEUR	LONGUEUR
OUR CODE	THICKNESS	WIDTH	LENGTH
QS106001	0,001	6"	100"
*****	0,0015	6"	100"
QS106002	0,002	6"	100"
QS106003	0,003	6"	100"
QS106004	0,004	6"	100"
QS106005	0,005	6"	100"
*****	0,006	6"	100"
QS106007	0,007	6"	100"
QS106008	0,008	6"	100"
QS106009	0,009	6"	100"
QS106010	0,010	6"	100"
QS106012	0,012	6"	100"
QS106015	0,015	6"	100"
QS106020	0,020	6"	100"
QS106025	0,025	6"	100"
*****	0,031	6"	100"

**ROULEAUX DE 12" X 120" DISPONIBLES SUR DEMANDE /
ROLLS OF 12" X 120" AVAILABLE ON REQUEST**

AUSSI DISPONIBLE / ALSO AVAILABLE :

**FEUILLE POUR CALE EN ACIER /
STEEL SHIM STOCK
6" X 100" & 12" X 120"**



Tel.: (819) 346-2903 / (888) 345-2903 Fax.: (819) 346-3389

Email: distributeur@boulonsestrie.com

PILES ALCALINES NOIRES / ALKALIN BATTERIES

NOTRE CODE	DESCRIPTION	FORMAT
OUR CODE	DESCRIPTION	PACKAGE
QA000001	AAA	24
QA000002	AA	24
QA000003	C	12
QA000004	D	12
QA000005	9 V (CARRÉE)	6
QA000006	6 V (ROBUSTE)	1
QA000007	1.5 V	1



LAMPES DE POCHE / FLASHLIGHT



NOTRE CODE	DESCRIPTION	FORMAT
OUR CODE	DESCRIPTION	PACKAGE
QA000009	ROBUSTE 2-D	1
QA000010	AVEC / C/W 6 V	1
QA000011	MAGNETIC 2-D	1

AUTRES / OTHERS

NOTRE CODE	DESCRIPTION
OUR CODE	DESCRIPTION
OU000012	PILE POUR VERNIER / FOR CALIPER
OU000013	PILE A-23-P
OU000014	PILE À LANTERNE / FLASHLIGHT BAT.



CORDES D'EXTENSION / EXTENSION CORDS

NOTRE CODE	DESCRIPTION	LONGUEUR
OUR CODE	DESCRIPTION	LENGTH
OU606310	3 COND. 16 GA.	10 M
OU606315	3 COND. 16 GA.	15 M
OU606330	3 COND. 16 GA.	30 M



Tel.: (819) 346-2903 / (888) 345-2903 Fax.: (819) 346-3389

Email: distributeur@boulonstrie.com

CE QUE NOUS AVONS EN INVENTAIRE / WHAT WE HAVE IN STOCK

NOTRE CODE	DIA. ROUE	PLAQUE	TYPE DE ROUE(MATÉRIEL)	CAP
OUR CODE	WHEEL DIA.	PLATE	WHEEL TYPE & *BEARING TYPE *	(LBS)
HK / HKR "HUSKY" SERIES CASTERS				
* Roulette économique et robuste / Long life at a reasonable price caster.				
* Une seule rangée de billes au pivot / Deep dish single race.				
* Disponible 2" , 2 1/2", 3", et 4" / Available in 2", 2 1/2", 3" and 4".				
QA001003	3"	SWIVEL	CAOUTCHOUC T-USAGE/MULTI-PURPOSE RUBBER *PLAIN*	200
QA002003	3"	RIGID	CAOUTCHOUC T-USAGE/MULTI-PURPOSE RUBBER*PLAIN*	200
QA003001	3"	SWIVEL	STAR-TECH URETHANE *BALL BEARING*	250
QA002002	3"	RIGID	PHÉNOLIQUE / PHENOLIC *ROLLER*	300
QA002461	4"	SWIVEL	CAOUTCHOUC T-USAGE/MULTI-PURPOSE RUBBER *ROLLER*	400
QA002462	4"	RIGID	CAOUTCHOUC T-USAGE/MULTI-PURPOSE RUBBER *ROLLER*	400



NOTRE CODE	DIA. ROUE	PLAQUE	TYPE DE ROUE(MATÉRIEL)	CAP
OUR CODE	WHEEL DIA.	PLATE	WHEEL TYPE & *BEARING TYPE *	(LBS)
LP / LPR "HUSKY" SERIES CASTERS				
* Roulette à usage multiple / Extremely versatile in many applications.				
* Double rangée de billes au pivot / Double ball race caster.				
* Disponible en 3", 4" et 5" / Available in 3", 4" and 5".				
QA002004	4"	RIGID	CAOUTCHOUC T-USAGE/MULTI-PURPOSE RUBBER *PLAIN*	250
QA001006	5"	SWIVEL	CAOUTCHOUC T-USAGE/MULTI-PURPOSE RUBBER *ROLLER*	250
QA002006	5"	RIGID	CAOUTCHOUC T-USAGE/MULTI-PURPOSE RUBBER *ROLLER*	250



NOTRE CODE	DIA. ROUE	PLAQUE	TYPE DE ROUE(MATÉRIEL)	CAP
OUR CODE	WHEEL DIA.	PLATE	WHEEL TYPE & *BEARING TYPE *	(LBS)
GP / GPR "GENERAL PURPOSE" SERIES CASTERS				
* Roulette à usage général / General purpose caster.				
* Double rangée de billes au pivot / Double ball race caster.				
* Pivot Scellé / Standards head seals				
* Plaque de fixation rencontre les standards Européen / Top plates size matches European standards.				
* Disponible 3", 4", 5" et 6" / Available in 3", 4", 5", and 6".				
QA419PSW	4"	RIGID	CAOUT.GRIS /ELIMINATOR GREY RUBBER *BALL BEARING*	220
QA411PSW	4" (FREIN)	SWIVEL	CAOUT.GRIS /ELIMINATOR GREY RUBBER *BALL BEARING*	220
QA001004	4"	SWIVEL	CAOUTCHOUC T-USAGE/MULTI-PURPOSE RUBBER *PLAIN*	300
QA001007	6"	SWIVEL	PHÉNOLIQUE / PHENOLIC *ROLLER*	600
QA002007	6"	RIGID	PHÉNOLIQUE / PHENOLIC *ROLLER*	600



SECTION S

ÉQUIPEMENT DE SÉCURITÉ / SAFETY EQUIPMENT

INFORMATION TECHNIQUE.....DÉBUT DE LA SECTION
TECHNICAL INFORMATION.....BEGINNING OF THIS SECTION

	DESCRIPTION	SECTION-PAGE
	LUNETTES. GLASSES.	S-1
	VISIÈRE. FACESHIELD.	S-1
	CASQUES DE SÉCURITÉ. SAFETY HELMETS.	S-2
	MASQUES ANTI-POUSSIÈRE. PARTICULE MASK.	S-2
	RESPIRATEUR DEMI-MASQUE. HALF-MASK RESPIRATOR.	S-3
	BOUCHONS D'OREILLES. EAR PLUGS.	S-3
		
	PROTECTEUR AUDITIF. EAR MUFF.	S-3
	GANTS. GLOVES.	S-3
	AUTRES DIVERS. OTHER PRODUCTS.	S-4 - S-5
		
		



Tel.: (819) 346-2903 / (888) 345-2903 Fax.: (819) 346-3389
Email: distributeur@boulonsestrie.com

LUNETTES



GLASSES

CE QUE NOUS AVONS EN TABLETTE / WHAT WE KEEP IN STOCK

NOTRE CODE	DESCRIPTION
OUR CODE	DESCRIPTION
180CL	CLAIRE , LUNETTE DE VISITE / NORTH CLEAR ,VISITOR SPECTACLES
58GTCL	CADRE CLASSIQUE (BRUN) , DE VISITE / SAFETY SPECTACLES, WINE FRAME, CLEAR LENS
Q2600300	LUNETTE FLEXIBLE "SOFTIES"(VEN. DIRECTE) / SOFTIES GOGGLE FLEXABLE (DIRECT VENTILATION)
8200 ***	CADRE NOIR, <u>LENTILLE CLAIRE</u> , AVEC CORDON (CONFORTABLE) / BLACK FRAME, CLEAR LENS
8220 ***	CADRE NOIR, <u>LENTILLE JAUNE</u> , (PROT. CÔTÉ) / BLACK FRAME, YELLOW LENS (SIDE PROT.)
*** NOTE: LENTILLES DE REMPLACEMENT DISPONIBLES / REPLACEMENT LENS AVAILABLE	

LUNETTES

UVEX

GLASSES

NOTRE CODE	DESCRIPTION
OUR CODE	DESCRIPTION
3000CL(UVEX)	CADRE BLEU ET <u>LENTILLE CLAIRE</u> / BLUE FRAME , <u>CLEAR LENS</u>
3001CL(UVEX)	CADRE NOIR ET <u>LENTILLE CLAIRE</u> / BLACK FRAME , <u>CLEAR LENS</u>
3002CL(UVEX)	CADRE NOIR ET <u>LENTILLE JAUNE</u> / BLACK FRAME , <u>AMBER LENS</u>

LENTILLES DE REMPLACEMENT / REPLACEMENT LENS

X3000CL	CLAIRE / CLEAR
X3000GY	GRIS / GREY
X3000AM	JAUNE / AMBER

VISIÈRE

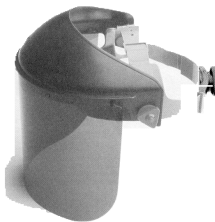

FACESHIELD

NOTRE CODE	DESCRIPTION
OUR CODE	DESCRIPTION
QC000004	ÉCRAN FACIAL MODÈLE À VIS / WITH SCREW (DIMENSIONS: 8 X 15 1/2 X ,55)
QC000003	SUPPORT À VISIÈRE SEULEMENT / FACESHIELD RACK

CASQUES
DE SECURITÉ



SAFETY
HELMETS

NOTRE CODE	DESCRIPTION
OUR CODE	DESCRIPTION
QC000001	<u>BLANC</u> AVEC SUPPORT AJUSTABLE À CLIQUET / <u>WHITE WITH RACK ADJUSTABLE</u>
QC000002	<u>JAUNE</u> AVEC SUPPORT AJUSTABLE À CLIQUET / <u>YELLOW WITH RACK ADJUSTABLE</u>
QC000006	<u>JAUNE</u> AVEC SUPPORT STANDARD / <u>YELLOW WITH STANDARD SUPPORT</u>
QC000007	<u>BLANC</u> AVEC SUPPORT STANDARD / <u>WHITE WITH STANDARD SUPPORT</u>
QC000008	<u>BLEU</u> AVEC SUPPORT STANDARD / <u>BLUE WITH STANDARD SUPPORT</u>
QC000009	<u>ROUGE</u> AVEC SUPPORT STANDARD / <u>RED WITH STANDARD SUPPORT</u>

MASQUES
ANTI-POUSSIÈRE

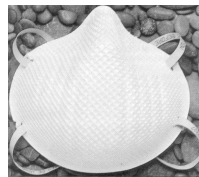

PARTICULE
MASK

NOTRE CODE	DESCRIPTION	FORMAT BTE
OUR CODE	DESCRIPTION	BOX QTY
2200 MOLDEX	MASQUE <u>SANS SOUPAPE D'EXPIRATION</u> (2 ELAST.) / <u>WITHOUT EXHALE VALVE</u>	20
FILTRE À 95% PARTICULES AÉROSOLS SANS HUILES / 95% FILTER LEVEL AGAINST PART. AEROSOLS FREE OF OIL		
2300 MOLDEX	MASQUE <u>AVEC SOUPAPE D'EXPIRATION</u> (2 ELAST.) / <u>WITH EXHALE VALVE</u>	10
FILTRE 95% CONTRE PARTICULES, UTILISÉ CONTRE FUMÉE DE SOUDURE / AGAINST PART. AEROSOL, FOR WELDING FUMES.		
8210 3M	MASQUE <u>SANS SOUPAPE D'EXPIRATION</u> (2 ÉLAST.) / <u>WITHOUT EXHALE VALVE</u>	20
POUR: ÉBARBAGE, SABLAGE ET AUTRES OPÉRATIONS POUSSIÈRES/ FOR: GRINDING, SANDING AND DUSTY OPERATIONS.		
8212 3M	<u>JOINT D'ÉTANCHÉITÉ ET SOUPAPE</u> (2 ÉLAST.) / <u>WITH FACESEAL & EXHALE VALVE</u>	10
POUR: SOUDURE, COUPE MÉTAL, ÉBARBAGE, SABLAGE ET OPÉRATIONS POUSS./ FOR: WELDING, METAL CUT, GRINDING...		
8577	MASQUE <u>AVEC SOUPAPE D'EXPIRATION</u> (2 ELAST.) / <u>WITH EXHALE VALVE</u>	10
CONTRE LES CONCENTRATIONS DE VAPEURS ORGANIQUES NUISIBLES / NUISANCE LEVEL ORGANIC VAPOR RELIEF		
**PARTICULES NUISIBLES PROVENANT D'AÉROSOLS MAIS NE DÉGAGEANT PAS DE VAPEURS <u>NOCIVES</u> /		
**LIQUID OR OIL BASED PARTICLES FROM SPRAYS THAT DO NOT ALSO EMIT <u>HARMFUL</u> VAPORS.		
SAK102	CONFORTABLE, LÉGER, <u>PINCES NASALES</u> / LIGHTWEIGHT, <u>METAL NOSECLIPS</u>	50
CONTRE POUSSIÈRES NON-TOXIQUE ET TRAVAUX LÉGERS/ AGAINST NON-TOXIC DUSTS & ALL RENOVATION WORK		

RESPIRATEUR
DEMI-MASQUE



RESPIRATOR
HALF-MASK

NOTRE CODE	DESCRIPTION
OUR CODE	DESCRIPTION
7700 (NORTH)	DEMI-MASQUE MEDIUM / HALF-MASK AIR-PURIFYING
75001	CARTOUCHE VAPEURS ORGANIQUES / ORGANIC VAPOR CARTRIDGE
75002	ANNEAU POUR CARTOUCHE / RETAINING RING FOR CARTRIDGE

BOUCHONS D'OREILLES



EAR PLUGS

PROTECTEUR AUDITIF

EAR MUFF

NOTRE CODE	DESCRIPTION	FORMAT BTE
OUR CODE	DESCRIPTION	BOX QTY
P200	BOUCHONS JAUNE STANDARD / EAR PLUGS YELLOW (NRR 29 DECIBELS)	200
P201	BOUCHONS MULTI COULEUR / SOFT FOAM SPARK PLUGS TAPER (NRR 30 DECIBELS)	200
P202	" <u>TAPER FIT</u> " JAUNE FLUO / YELLOW NEON <u>TAPER FIT</u> (NRR 33 DECIBELS)	200
29820	PROTECTEUR AUDITIF / EAR MUFF MODÈLE 1000 (NRR 20 DECIBELS)	1

GANTS

GLOVES

GROS INVENTAIRE

LARGE INVENTORY

GANTS EN CUIR LISSE ET/OU FENDU/BROSSÉ / SPLIT & SMOOTH LEATHER GLOVES

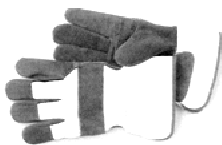

GANTS D'HIVER / WINTER GLOVES



GANTS EN COTON / KNITTED GLOVES



GANTS LATEX / DISPOSABLE LATEX GLOVES



**GANTS DE SOUDURE CUIR FENDU GRIS OU KAVELAR ROUGE /
WELDING GLOVES GRAY OR RED KAVELAR**



**GANTS ENDUITS / COATED GLOVES
RÉSISTANTS AUX PRODUITS CHIMIQUES / CHEMICAL GLOVES**

AUSSI DISPONIBLE / ALSO AVAILABLE

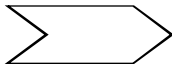

VÊTEMENTS DE PLUIE (JAUNE) / YELLOW RAINSUIT



VÊTEMENTS PROTECTEURS / PROTECTIVE CLOTHING

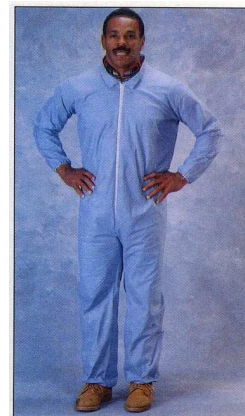

RUBAN "DANGER" JAUNE / YELLOW "DANGER" TAPE



ET AUTRES.....

AUSSI DISPONIBLE / ALSO AVAILABLE

ENSEMBLE DE CROCHETS DE PROTECTION
/ NORTH FALL PROTECTION



HARNAIS DE SÉCURITÉ /
RETRACTABLE LIFELINE



CÔNES DE SIGNALISATION
DURABLE PVC TRAFFIC CONES



RUBANS D'AVERTISSEMENT/ CAUTION TAPES



TROUSSES DE PREMIERS SOINS / FIRST AID KITS

