

# SECTION B

## VIS À PRESSION / SOCKET SCREWS

INFORMATION TECHNIQUE.....DÉBUT DE LA SECTION  
 TECHNICAL INFORMATION.....BEGINNING OF THIS SECTION

DESCRIPTION	SECTION - PAGE
 VIS À TÊTE CYLINDRIQUE À 6 PANS CREUX, <i>GROS FILETS</i> , NOIR. SOCKET HEAD CAP SCREWS, <i>NATIONAL COARSE</i> , BARE.	B-1
 VIS À TÊTE CYLINDRIQUE À 6 PANS CREUX, <i>GROS FILETS</i> , ZINC. SOCKET HEAD CAP SCREWS, <i>NATIONAL COARSE</i> , PLATED.	SUR DEMANDE ON REQUEST
 VIS À TÊTE CYLINDRIQUE À 6 PANS CREUX, <i>FILETS FINS</i> , NOIR. SOCKET HEAD CAP SCREWS, <i>NATIONAL FINE</i> , BARE.	B-11
 VIS À TÊTE CYLINDRIQUE À 6 PANS CREUX, <i>FILETS FINS</i> , ZINC. SOCKET HEAD CAP SCREWS, <i>NATIONAL FINE</i> , PLATED.	SUR DEMANDE ON REQUEST
 VIS À TÊTE CYLINDRIQUE À 6 PANS CREUX, <i>GROS FILETS &amp; FINS</i> , SS-304/ 18-8. SOCKET HEAD CAP SCREWS, <i>NATIONAL COARSE &amp; FINE</i> , SS-304/ 18-8.	B-17
 VIS À TÊTE CYLINDRIQUE À 6 PANS CREUX, <i>GROS FILETS</i> , SS-316. SOCKET HEAD CAP SCREWS, <i>NATIONAL COARSE</i> , SS-316.	B-20
 VIS À TÊTE CYLINDRIQUE À 6 PANS CREUX, <i>MÉTRIQUE</i> , GRADE 12.9, NOIR. SOCKET HEAD CAP SCREWS, <i>METRIC</i> , <i>GRADE 12.9</i> , BARE.	B-21
 VIS À TÊTE CYLINDRIQUE À 6 PANS CREUX, <i>MÉTRIQUE</i> , SS-304 & SS-316. SOCKET HEAD CAP SCREWS, <i>METRIC</i> , SS-304 & SS-316.	SUR DEMANDE ON REQUEST
 VIS À TÊTE BASSE À 6 PANS CREUX, <i>GROS FILETS</i> , NOIR. LOW HEAD SOCKET CAP SCREWS, <i>NATIONAL COARSE</i> , BARE	B-29
 VIS À TÊTE BASSE À 6 PANS CREUX, <i>MÉTRIQUE DIN 7984</i> , NOIR. LOW HEAD SOCKET CAP SCREWS, <i>METRIC DIN7984</i> , BARE.	B-31
 VIS À TÊTE FRAISÉE À 6 PANS CREUX, <i>GROS FILETS</i> , NOIR. FLAT HEAD SOCKET CAP SCREWS, <i>NATIONAL COARSE</i> , BARE.	B-32
 VIS À TÊTE FRAISÉE À 6 PANS CREUX, <i>GROS FILETS</i> , ZINC. FLAT HEAD SOCKET CAP SCREWS, <i>NATIONAL COARSE</i> , PLATED	SUR DEMANDE ON REQUEST

## SECTION B

### VIS À PRESSION / SOCKET SCREWS

	DESCRIPTION	SECTION - PAGE
	VIS À TÊTE FRAISÉE À 6 PANS CREUX, <i>FILETS FINS</i> , NOIR. FLAT HEAD SOCKET CAP SCREWS, <i>NATIONAL FINE</i> , BARE.	B-37
	VIS À TÊTE FRAISÉE À 6 PANS CREUX, <i>FILETS FINS</i> , ZINC. FLAT HEAD SOCKET CAP SCREWS, <i>NATIONAL FINE</i> , PLATED	SUR DEMANDE ON REQUEST
	VIS À TÊTE FRAISÉE À 6 PANS CREUX, <i>GROS FILETS &amp; FINS</i> , SS-304. FLAT HEAD SOCKET CAP SCREWS, <i>NATIONAL COARSE &amp; FINE</i> , SS-304.	B-40
	VIS À TÊTE FRAISÉE À 6 PANS CREUX, <i>MÉTRIQUE</i> , GRADE 10.9, NOIR. FLAT HEAD SOCKET CAP SCREWS, <i>METRIC</i> , GRADE 10.9, BARE.	B-42
	VIS À TÊTE FRAISÉE À 6 PANS CREUX, <i>MÉTRIQUE</i> , A2 (304) & 316 FLAT HEAD SOCKET CAP SCREWS, <i>METRIC</i> , A2 (304) & 316	SUR DEMANDE ON REQUEST
	VIS DE PRESSION À 6 PANS CREUX, <i>GROS FILETS</i> , NOIR. SOCKET SET SCREWS CUP POINT, <i>NATIONAL COARSE</i> , BARE .	B-45
	VIS DE PRESSION À 6 PANS CREUX, <i>GROS FILETS</i> , ZINC. SOCKET SET SCREWS CUP POINT, <i>NATIONAL COARSE</i> , PLATED .	SUR DEMANDE ON REQUEST
	VIS DE PRESSION À 6 PANS CREUX, <i>FILETS FINS</i> , NOIR. SOCKET SET SCREWS CUP POINT, <i>NATIONAL FINE</i> , BARE .	B-50
	VIS DE PRESSION À 6 PANS CREUX, <i>FILETS FINS</i> , ZINC. SOCKET SET SCREWS CUP POINT, <i>NATIONAL FINE</i> , PLATED .	SUR DEMANDE ON REQUEST
	VIS DE PRESSION À 6 PANS CREUX, <i>GROS FILETS &amp; FINS</i> , SS-304. SOCKET SET SCREWS CUP POINT, <i>NATIONAL COARSE &amp; FINE</i> , SS-304 .	B-54
	VIS DE PRESSION À 6 PANS CREUX <i>MÉTRIQUE</i> , GRADE 12.9 NOIR. SOCKET SET SCREWS CUP POINT, <i>METRIC</i> , GRADE 12.9, BARE.	B-56
	VIS DE PRESSION À 6 PANS CREUX <i>MÉTRIQUE</i> , A2 (SS-304) & SS-316. SOCKET SET SCREWS CUP POINT, <i>METRIC</i> , A2 (SS-304) & SS-316.	SUR DEMANDE ON REQUEST

## SECTION B

### VIS À PRESSION / SOCKET SCREWS

	DESCRIPTION	SECTION - PAGE
	<b>VIS DE PRESSION À 6 PANS CREUX, <i>POINTE CONIQUE</i>.</b> <b>SOCKET SET SCREWS CUP POINT, <i>CONE POINT</i>.</b>	SUR DEMANDE ON REQUEST
	<b>VIS DE PRESSION À 6 PANS CREUX, <i>POINTE DEMI-TÉTON</i>.</b> <b>SOCKET SET SCREWS CUP POINT, <i>HALF DOG POINT</i>.</b>	SUR DEMANDE ON REQUEST
	<b>VIS DE PRESSION À 6 PANS CREUX, <i>POINTE MOLETÉE</i>.</b> <b>SOCKET SET SCREWS CUP POINT, <i>KNURLED POINT</i>.</b>	SUR DEMANDE ON REQUEST
	<b>VIS DE PRESSION À 6 PANS CREUX, <i>POINTE OVALE</i>.</b> <b>SOCKET SET SCREWS CUP POINT, <i>OVAL POINT</i>.</b>	SUR DEMANDE ON REQUEST
	<b>VIS DE PRESSION À 6 PANS CREUX, <i>POINTE PLATE</i>.</b> <b>SOCKET SET SCREWS CUP POINT, <i>FLAT POINT</i>.</b>	SUR DEMANDE ON REQUEST
	<b>VIS À TÊTE RONDE À 6 PANS CREUX, <i>GROS FILETS</i>, NOIR.</b> <b>BUTTON HEAD SOCKET CAP SCREWS, <i>NATIONAL COARSE</i>, BARE.</b>	B-59
	<b>VIS À TÊTE RONDE À 6 PANS CREUX, <i>GROS FILETS</i>, ZINC.</b> <b>BUTTON HEAD SOCKET CAP SCREWS, <i>NATIONAL COARSE</i>, PLATED.</b>	SUR DEMANDE ON REQUEST
	<b>VIS À TÊTE RONDE À 6 PANS CREUX, <i>FILETS FINS</i>, NOIR.</b> <b>BUTTON HEAD SOCKET CAP SCREWS, <i>NATIONAL FINE</i>, BARE.</b>	B-62
	<b>VIS À TÊTE RONDE À 6 PANS CREUX, <i>FILETS FINS</i>, ZINC.</b> <b>BUTTON HEAD SOCKET CAP SCREWS, <i>NATIONAL FINE</i>, PLATED.</b>	SUR DEMANDE ON REQUEST
	<b>VIS À TÊTE RONDE À 6 PANS CREUX, <i>GROS FILETS &amp; FINS</i>, SS-304/ 18-8.</b> <b>BUTTON HEAD SOCKET CAP SCREWS, <i>NATIONAL COARSE &amp; FINE</i>, SS-304/ 18-8.</b>	B-64
	<b>VIS À TÊTE RONDE À 6 PANS CREUX, <i>MÉTRIQUE</i>, GRADE 12.9, NOIR.</b> <b>BUTTON HEAD SOCKET CAP SCREWS, <i>METRIC</i>, GRADE 12.9, BARE.</b>	B-66
	<b>VIS À ÉPAULEMENT À TÊTE CREUSE 6 PANS CREUX, <i>GROS FILETS</i>, NOIR.</b> <b>SOCKET HEAD SHOULDER SCREWS, <i>NATIONAL COARSE</i>, BARE.</b>	B-67
	<b>VIS À ÉPAULEMENT À TÊTE CREUSE 6 PANS CREUX, <i>GROS FILETS</i>, ZINC.</b> <b>SOCKET HEAD SHOULDER SCREWS, <i>NATIONAL COARSE</i>, PLATED.</b>	SUR DEMANDE ON REQUEST





# SECTION B

## VIS À PRESSION / SOCKET SCREWS

DESCRIPTION	SECTION - PAGE
 <p>VIS À ÉPAULEMENT À TÊTE CREUSE 6 PANS CREUX, <i>MÉTRIQUE DIN 9841</i>, NOIR.            SOCKET HEAD SHOULDER SCREWS, <i>METRIC DIN 9841</i>, BARE.</p>	B-73
 <p>VIS À ÉPAULEMENT À TÊTE CREUSE 6 PANS CREUX, SS304.            SOCKET HEAD SHOULDER SCREWS, SS304</p>	SUR DEMANDE ON REQUEST
 <p>VIS DE PRESSION À TÊTE CARRÉE, <i>GROS FILETS</i>, NOIR.            SQUARE HEAD SET SCREWS, <i>NATIONAL COARSE</i>, BARE.</p>	B-75
 <p>VIS DE PRESSION À TÊTE CARRÉE, <i>MÉTRIQUE DIN 479</i>, NOIR.            SQUARE HEAD SET SCREWS, <i>METRIC DIN 479</i>, BARE.</p>	SUR DEMANDE ON REQUEST
 <p>BOUCHONS FILETÉS HEXAGONAUX, NOIR            PIPE PLUGS HEX, BARE</p>	B-78
 <p>BOUCHONS FILETÉS HEXAGONAUX ACIER INOXYDABLE &amp; MÉTRIQUE            PIPE PLUGS HEX STAINLESS STEEL &amp; METRIC</p>	SUR DEMANDE ON REQUEST
 <p>CLÉS HEXAGONALES, COURTE &amp; LONGUE, NOIR            HEX KEYS "ALLEN", SHORT &amp; LONG, BARE.</p>	B-79
 <p>CLÉS HEXAGONALES, <i>MÉTRIQUE</i>, COURTE &amp; LONGUE, NOIR.            HEX KEYS "ALLEN", <i>METRIC</i>, SHORT &amp; LONG, BARE.</p>	B-80
 <p>CLÉS HEXAGONALES, <i>MÉTRIQUE</i>, BOUT EN ROND. COURTE &amp; LONGUE, NOIR.            HEX KEYS "ALLEN", <i>METRIC</i>, BALL POINT. SHORT &amp; LONG, BARE.</p>	B-80
 <p>CLÉS HEXAGONALES BOUT EN ROND, NOIR.            HEX. KEYS "ALLEN", BALL POINT, BARE.</p>	B-81
 <p>TOURNEVIS HEXAGONE, BOUT EN ROND            HEX SCREWDRIVERS, BALL POINT</p>	B-81
 <p>CLÉS ALLEN MANCHE EN T, BOUT ROND.            ALLEN KEYS T-HANDLE, BALL POINT.</p>	B-82
 <p>JEUX DE CLÉS, BOUT EN ROND, ZINC.            ALLEN KEYS SETS, BALL POINT, PLATED.</p>	B-82

# SECTION B

## VIS À PRESSION / SOCKET SCREWS

	DESCRIPTION	SECTION - PAGE
	<b>JEUX DE CLÉS, BOUT EN ROND, NOIR.</b> <b>ALLEN KEYS SETS, BALL POINT, BARE.</b>	<b>B-83</b>
	<b>ENS. CLÉS HEXAGONALES</b> <b>HEX FOLD UP KEY SETS</b>	<b>B-83</b>
	<b>TOURNEVIS BOUT EN ROND</b> <b>BALL POINT SCREWDRIVERS</b>	<b>B-83</b>
	<b>ENSEMBLES DOUBLES</b> <b>DOUBLE PACKS</b>	<b>B-83</b>
	<b>ENSEMBLE TRIPLE</b> <b>TRIPLE PACK</b>	<b>B-83</b>

# DIMENSIONS OF SOCKET HEAD CAP SCREWS

CLASS FIT 3A  
HARDNESS RC 38-43

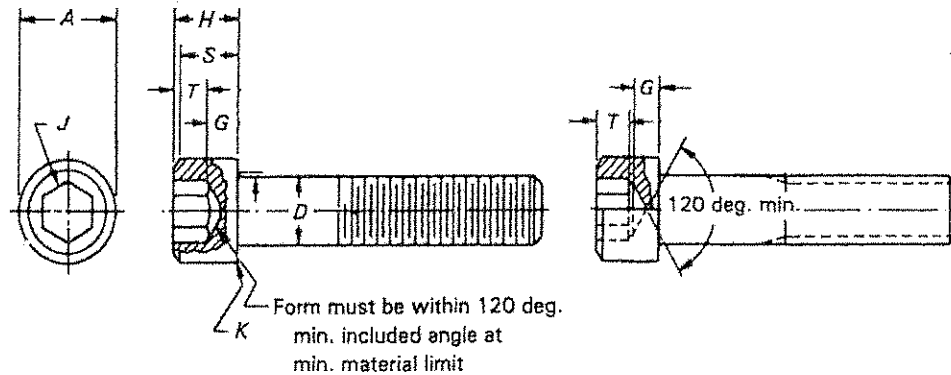

Nominal Size or Basic Screw Diameter	D		A		H		S	J	T	G	K		
	Body Diameter		Head Diameter		Head Height		Head Side Height	Hexagon Socket Size	Key Engagement	Wall Thickness	Chamfer of Radius		
	Max.	Min.	Max.	Min.	Max.	Min.	Min.	Norm.	Min.	Min.	Max.		
0	0.0600	0.0600	0.0568	0.096	0.091	0.060	0.057	0.054		0.050	0.025	0.020	0.003
1	0.0730	0.0730	0.0504	0.118	0.112	0.073	0.070	0.066	1/16	0.062	0.031	0.025	0.003
2	0.0860	0.0860	0.0822	0.140	0.134	0.086	0.083	0.077	5/64	0.078	0.038	0.029	0.003
3	0.0990	0.0990	0.0949	0.161	0.154	0.099	0.095	0.089	5/64	0.078	0.044	0.034	0.003
4	0.1120	0.1120	0.1075	0.183	0.176	0.112	0.108	0.101	3/32	0.094	0.051	0.030	0.005
5	0.1250	0.1250	0.1202	0.205	0.198	0.125	0.121	0.112	3/32	0.094	0.057	0.043	0.005
6	0.1380	0.1380	0.1329	0.226	0.218	0.138	0.134	0.124	7/64	0.109	0.064	0.047	0.005
8	0.1640	0.1640	0.1585	0.270	0.262	0.164	0.159	0.148	9/64	0.141	0.077	0.056	0.005
10	0.1900	0.1900	0.1840	0.312	0.303	0.190	0.185	0.171	5/32	0.156	0.090	0.065	0.005
12	0.216	0.2160	0.2100	0.324	0.314	0.216	0.210	0.194	5/32	0.156	0.103	0.073	0.005
1/4	0.2500	0.2500	0.2435	0.375	0.365	0.250	0.244	0.225	3/16	0.188	0.120	0.095	0.008
5/16	0.3125	0.3125	0.3053	0.469	0.457	0.312	0.306	0.281	1/4	0.250	0.151	0.119	0.008
3/8	0.3750	0.3750	0.3678	0.561	0.550	0.375	0.368	0.337	5/16	0.312	0.182	0.143	0.008
7/16	0.4375	0.4375	0.4294	0.656	0.642	0.438	0.430	0.394	3/8	0.375	0.213	0.166	0.010
1/2	0.5000	0.5000	0.4919	0.750	0.735	0.500	0.492	0.450	3/8	0.375	0.245	0.190	0.010
5/8	0.6250	0.6250	0.6163	0.938	0.921	0.625	0.616	0.562	1/2	0.500	0.307	0.238	0.010
3/4	0.7500	0.7500	0.7406	1.125	1.107	0.750	0.740	0.675	5/8	0.625	0.370	0.285	0.010
7/8	0.8750	0.8750	0.8647	1.312	1.293	0.875	0.864	0.787	3/4	0.750	0.432	0.333	0.015
1	1.0000	1.0000	0.9886	1.500	1.479	1.000	0.988	0.900	3/4	0.750	0.495	0.380	0.015
1-1/8	1.1250	1.1250	1.1086	1.688	1.665	1.125	1.111	1.012	7/8	0.875	0.557	0.428	0.015
1-1/4	1.2500	1.2500	1.2336	1.875	1.852	1.250	1.236	1.125	7/8	0.875	0.620	0.475	0.015
1-3/8	1.3750	1.3750	1.3568	2.062	2.038	1.375	1.360	1.237	1	1.000	0.682	0.523	0.015
1-1/2	1.5000	1.5000	1.4818	2.250	2.224	1.500	1.485	1.350	1	1.000	0.745	0.570	0.015
1-3/4	1.7500	1.7500	1.7295	2.625	2.597	1.750	1.734	1.575	1-1/4	1.250	0.870	0.665	0.015
2	2.0000	2.0000	1.9780	3.000	2.970	2.000	1.983	1.800	1-1/2	1.500	0.995	0.760	0.015
2-1/4	2.2500	2.2500	2.2280	3.375	3.344	2.250	2.232	2.025	1-3/4	1.750	1.120	0.855	0.031
2-1/2	2.5000	2.5000	2.4762	3.750	3.717	2.500	2.481	2.250	1-3/4	1.750	1.245	0.950	0.031
2-3/4	2.7500	2.7500	2.7262	4.125	4.090	2.750	2.730	2.475	2-1/4	2.000	1.370	1.045	0.031
3	3.0000	3.0000	2.9762	4.500	4.464	3.000	2.979	2.700	2-1/4	2.250	1.495	1.140	0.031
3-1/4	3.2500	3.2500	3.2262	4.875	4.837	3.250	3.228	2.925	2-1/4	2.250	1.620	1.235	0.031
3-1/2	3.5000	3.5000	3.4762	5.250	5.211	3.500	3.478	3.150	2-3/4	2.750	1.745	1.330	0.031
3-3/4	3.7500	3.7500	3.7262	5.625	5.584	3.750	3.727	3.375	2-3/4	2.750	1.870	1.425	0.031
4	4.0000	4.0000	3.9762	6.000	5.958	4.000	3.976	3.600	3-1/4	3.000	1.995	1.520	0.031

# DIMENSIONS OF FLAT COUNTERSUNK SOCKET HEAD CAP SCREWS

CLASS FIT 3A  
HARDNESS RC 36-43

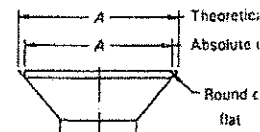
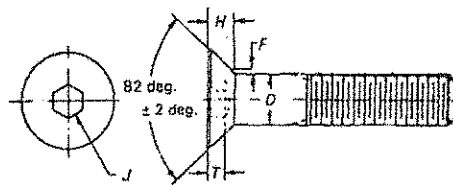

Nominal Size or Basic Screw Diameter	D		A		H		J	T	F	
	Body Diameter		Head Diameter		Head Height					
	Max.	Min.	Theoretical Sharp Max.	Abs. Min.	Reference	Flushness Tolerance	Hexagon Socket Size	Key Engagement	Fillet Extension Above D Max.	
			Max.	Min.						
10	0.0600	0.0600	0.0568	0.138	0.117	0.044	0.006	0.035	0.025	0.006
11	0.0730	0.0730	0.0695	0.168	0.143	0.054	0.007	0.050	0.031	0.008
12	0.0860	0.0860	0.0822	0.197	0.168	0.064	0.008	0.050	0.038	0.010
13	0.0990	0.0990	0.0949	0.226	0.193	0.073	0.010	1/16 0.062	0.044	0.010
4	0.1120	0.1120	0.1075	0.255	0.218	0.083	0.011	1/16 0.062	0.055	0.012
5	0.1250	0.1250	0.1202	0.281	0.240	0.090	0.012	5/64 0.078	0.061	0.014
6	0.1380	0.1380	0.1329	0.307	0.263	0.097	0.013	5/64 0.078	0.066	0.015
8	0.1640	0.1640	0.1585	0.359	0.311	0.112	0.014	3/32 0.094	0.076	0.015
10	0.1900	0.1900	0.1840	0.411	0.359	0.127	0.015	1/8 0.125	0.087	0.015
1/4	0.2500	0.2500	0.2435	0.531	0.480	0.161	0.016	5/32 0.156	0.111	0.015
5/16	0.3125	0.3125	0.3053	0.656	0.600	0.198	0.017	3/16 0.188	0.135	0.015
3/8	0.3750	0.3750	0.3678	0.781	0.720	0.234	0.018	7/32 0.219	0.159	0.015
7/16	0.4375	0.4375	0.4294	0.844	0.781	0.234	0.018	1/4 0.250	0.159	0.015
1/2	0.5000	0.5000	0.4919	0.938	0.872	0.251	0.018	5/16 0.312	0.172	0.015
5/8	0.6250	0.6250	0.6163	1.188	1.112	0.324	0.022	3/8 0.375	0.220	0.015
3/4	0.7500	0.7500	0.7406	1.438	1.355	0.396	0.024	1/2 0.500	0.220	0.015
7/8	0.8750	0.8750	0.8647	1.688	1.604	0.468	0.025	9/16 0.562	0.248	0.015
1	1.0000	1.0000	0.9886	1.938	1.841	0.540	0.028	5/8 0.625	0.297	0.015
1-1/8	1.1250	1.1250	1.1086	2.188	2.079	0.611	0.031	3/4 0.750	0.325	0.031
1-1/4	1.2500	1.2500	1.2336	2.438	2.316	0.683	0.035	7/8 0.875	0.358	0.031
1-3/8	1.3750	1.3750	1.3568	2.688	2.553	0.755	0.038	7/8 0.875	0.402	0.031
1-1/2	1.5000	1.5000	1.4848	2.938	2.791	0.827	0.042	1 1.000	0.435	0.031

# DIMENSIONS OF LOW-HEAD SOCKET HEAD CAP SCREWS

CLASS FIT 3A  
HARDNESS RC 38-43

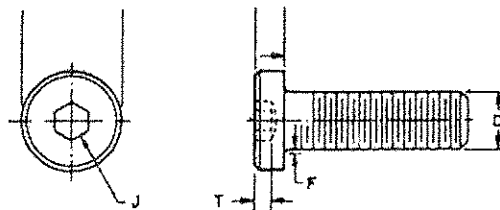

Nominal Size	Basic Screw Diam. D	A-Head Diameter		H-Head Height		J Hex Socket Size	T Key Engagement	F Fillet Above D	
		Max.	Min.	Max.	Min.	Min.	Min.	Max.	Min.
4	0.1120	.183	.178	.056	.053	.0500	.038	.009	.005
5	0.1250	.205	.200	.062	.059	.0625	.044	.010	.006
6	0.1380	.226	.221	.069	.066	.0625	.050	.010	.006
8	0.1640	.270	.265	.082	.079	.0781	.060	.012	.007
10	0.1900	.312	.307	.095	.092	.093	.072	.014	.009
1/4	0.2500	.375	.369	.125	.121	.1250	.094	.014	.009
5/16	0.3125	.437	.431	.156	.152	.1562	.120	.017	.012
3/8	0.3750	.562	.556	.187	.182	.1875	.145	.020	.015
7/16	0.4375	.625	.618	.218	.213	.2188	.166	.023	.018
1/2	0.5000	.750	.743	.250	.244	.2500	.184	.026	.020
5/8	0.6250	.875	.867	.312	.306	.3125	.250	.032	.024

# DIMENSIONS OF SOCKET SET SCREWS

CLASS FIT 3A  
HARDNESS RC 45-53

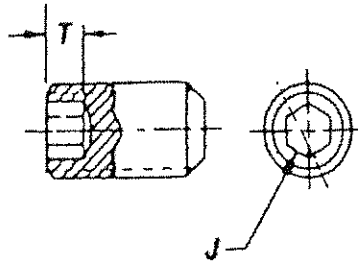

OVAL POINT

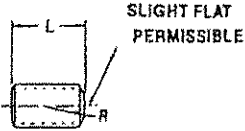

CUP POINT (KNURL)

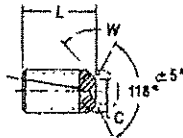

FLAT POINT

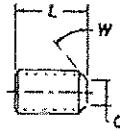

HALF DOG POINT

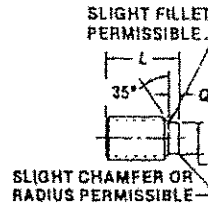

CONE POINT

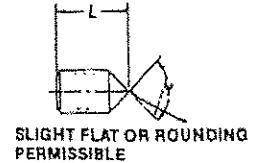

Nominal Size or Basic Screw Diameter	J		T		C		R	Y	P		Q		Recommended Seating Torque (Inch-lbs.)		
	Hexagon Socket Size		Min Key Engagement to Develop Functional Capability of Key		Cup and Flat Point Diameters		Oval Point Radius	Cone Point Angle 90° ± 2 Deg These Lengths or Longer	Half Dog Point						
			Hex Socket 7 <sub>H</sub> Min		Max	Min	Basic	118° ± 2 Deg for Shorter Nominal Lengths	Diameter		Length		Alloy Steel	Stainless	Nom. Min. Screw Length
	Nom								Max	Min	Max	Min			
0	0.0600	0.028	0.050	0.033	0.027	0.045	0.09	0.040	0.037	0.017	0.013	1.0	.4	3/32	
1	0.0730	0.028	0.060	0.040	0.033	0.055	0.09	0.049	0.045	0.021	0.017	1.8	1.2	1/8	
2	0.0860	0.035	0.060	0.047	0.039	0.064	0.13	0.057	0.053	0.024	0.020	1.8	1.2	1/8	
3	0.0990	0.050	0.070	0.054	0.045	0.074	0.13	0.066	0.062	0.027	0.023	5	4	5/32	
4	0.1120	0.050	0.070	0.061	0.051	0.084	0.19	0.075	0.070	0.030	0.026	5	4	5/32	
5	0.1250	1/16	0.080	0.067	0.057	0.094	0.19	0.083	0.078	0.033	0.027	10	7	5/32	
6	0.1380	1/16	0.080	0.074	0.064	0.104	0.19	0.092	0.087	0.038	0.032	10	7	3/16	
8	0.1640	5/64	0.090	0.087	0.076	0.123	0.25	0.109	0.103	0.043	0.037	20	16	3/16	
10	0.1900	3/32	0.100	0.102	0.088	0.142	0.25	0.127	0.120	0.049	0.041	36	26	3/16	
1/4	0.2500	1/8	0.125	0.132	0.118	0.188	0.31	0.156	0.149	0.067	0.059	87	70	5/16	
5/16	0.3125	5/32	0.156	0.172	0.156	0.234	0.38	0.203	0.195	0.082	0.074	165	130	3/8	
3/8	0.3750	3/16	0.188	0.212	0.194	0.281	0.44	0.250	0.241	0.099	0.089	290	230	7/16	
7/16	0.4375	7/32	0.219	0.252	0.232	0.328	0.50	0.297	0.287	0.114	0.104	430	340	1/2	
1/2	0.5000	1/4	0.250	0.291	0.270	0.375	0.57	0.344	0.334	0.130	0.120	620	500	9/16	
5/8	0.6250	5/16	0.312	0.371	0.347	0.469	0.75	0.469	0.456	0.164	0.148	1,325	980	11/16	
3/4	0.7500	3/8	0.375	0.450	0.425	0.562	0.88	0.562	0.549	0.196	0.180	2,400	1,700	3/4	
7/8	0.8750	1/2	0.500	0.530	0.502	0.656	1.00	0.658	0.642	0.227	0.211	3,600	3,000	3/4	
1-1/8	1.0000	9/16	0.562	0.609	0.579	0.750	1.13	0.750	0.734	0.260	0.240	5,000	4,000	7/8	
1-1/8	1.1250	9/16	0.562	0.689	0.655	0.844	1.25	0.844	0.826	0.291	0.271	7,200	5,600	1	
1-1/4	1.2500	5/8	0.625	0.767	0.733	0.938	1.50	0.938	0.920	0.323	0.303	9,600	7,700	1-1/8	
1-3/8	1.3750	5/8	0.625	0.848	0.808	1.031	1.63	1.031	1.011	0.354	0.334	9,600	7,700	1-1/4	
1-1/2	1.5000	3/4	0.750	0.926	0.886	1.125	1.75	1.125	1.105	0.385	0.365	11,320	9,100	1-1/4	



# DIMENSIONS OF HEXAGON SOCKET HEAD SHOULDER SCREWS

CLASS FIT 3A  
HARDNESS RC 36-43

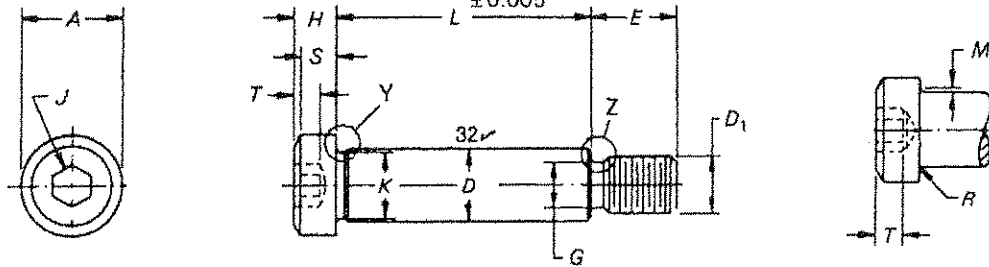

Nominal Size or Basic Shoulder Diameter	D		A		H		S	J		T	M	R	
	Shoulder Diameter		Head Diameter		head Height		Head Side Height	Hexagon Socket Size		Key Engagement	Head Fillet Extension Above D	Head Fillet Radius	
	Max.	Min.	Max.	Min.	Max.	Min.	Min.	Nom.	Min.	Max.	Min.		
1/4	0.250	0.2480	0.2480	0.375	0.357	0.188	0.177	0.157	1/8	0.125	0.094	0.014	0.009
5/16	0.312	0.3105	0.3085	0.438	0.419	0.219	0.209	0.183	5/32	0.156	0.117	0.017	0.012
3/8	0.375	0.3730	0.3710	0.562	0.543	0.250	0.240	0.209	3/16	0.188	0.141	0.020	0.015
1/2	0.500	0.4980	0.4960	0.750	0.729	0.312	0.302	0.262	1/4	0.250	0.188	0.026	0.020
5/8	0.625	0.6230	0.6210	0.875	0.853	0.375	0.365	0.315	5/16	0.312	0.234	0.032	0.024
3/4	0.750	0.7480	0.7460	1.000	0.977	0.500	0.490	0.421	3/8	0.375	0.281	0.039	0.030
1	1.000	0.9980	0.9960	1.312	1.287	0.625	0.610	0.527	1/2	0.500	0.375	0.050	0.040
1-1/4	1.250	1.2480	1.2460	1.750	1.723	0.750	0.735	0.633	5/8	0.625	0.469	0.060	0.050
1-1/2	1.500	1.4980	1.4960	2.125	2.095	1.000	0.980	0.842	7/8	0.875	0.656	0.070	0.060
1-3/4	1.750	1.7480	1.7460	2.375	2.345	1.125	1.105	0.948	1	1.000	0.750	0.080	0.070
2	2.000	1.9980	1.9960	2.750	2.720	1.250	1.230	1.054	1-1/4	1.250	0.937	0.090	0.080

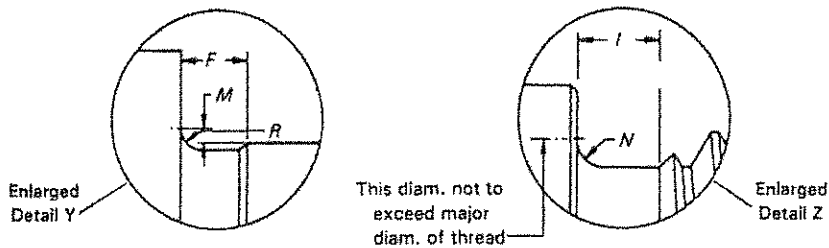

Nominal Size or Basic Shoulder Diameter	K	F	D <sub>t</sub>		Threads/in.	G		I	N		E	
	Shoulder Neck Diameter	Shoulder Neck Width	Nominal Thread Size or Basic Thread Diameter			Thread Neck Diameter		Thread Neck Width	Thread Neck Fillet		Thread Length	
	Min.	Max.			Max.	Min.	Max.	Max.	Min.	Basic		
1/4	0.250	0.227	0.093	10	0.1900	24	0.142	0.133	0.083	0.023	0.017	0.375
005/16	0.312	0.289	0.093	1/4	0.2500	20	0.193	0.182	0.100	0.028	0.022	0.438
3/8	0.375	0.352	0.093	5/16	0.3125	18	0.249	0.237	0.111	0.031	0.025	0.500
1/2	0.500	0.477	0.093	3/8	0.3750	16	0.304	0.291	0.125	0.035	0.029	0.625
5/8	0.625	0.602	0.093	1/2	0.5000	13	0.414	0.397	0.154	0.042	0.036	0.750
3/4	0.750	0.727	0.093	5/8	0.6250	11	0.521	0.502	0.182	0.051	0.045	0.875
1	1.000	0.977	0.125	3/4	0.7500	10	0.638	0.616	0.200	0.055	0.049	1.000
1-1/4	1.250	1.227	0.125	7/8	0.8750	9	0.750	0.726	0.222	0.062	0.056	1.125
01-1/2	1.500	1.478	0.125	1-1/8	1.1250	7	0.964	0.934	0.286	0.072	0.066	1.500
1-3/4	1.750	1.728	0.125	1-1/4	1.2500	7	1.089	1.059	0.286	0.072	0.066	1.750
2	2.000	1.978	0.125	1-1/2	1.5000	6	1.307	1.277	0.333	0.102	0.096	2.000

# DIMENSIONS OF SQUARE HEAD SET SCREWS

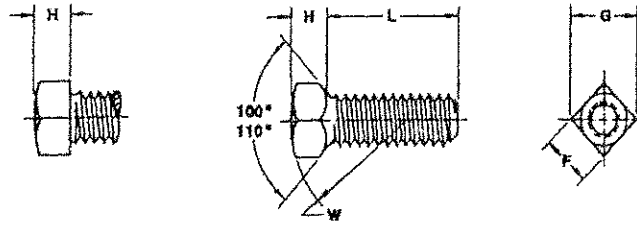

Nominal Size or Basic Screw Diameter	F		G		H		K		S	U	W	
	Width Across Flats		Width Across Corners		Head Height		Neck Relief Diameter		Neck Relief Fillet Radius	Relief Relief Width	Head Radius	
	Max	Min	Max	Min	Max	Min	Max	Min	Max	Min	Min	
10	0.1900	0.188	0.180	0.265	0.247	0.148	0.134	0.145	0.140	0.027	0.083	0.48
1/4	0.2500	0.250	0.241	0.354	0.331	0.196	0.178	0.185	0.170	0.032	0.100	0.62
5/16	0.3125	0.312	0.302	0.442	0.415	0.245	0.224	0.240	0.225	0.036	0.111	0.78
3/8	0.3750	0.375	0.362	0.530	0.497	0.293	0.270	0.294	0.279	0.041	0.125	0.94
7/16	0.4365	0.438	0.423	0.619	0.581	0.341	0.315	0.345	0.330	0.046	0.153	1.09
1/2	0.5000	0.500	0.484	0.707	0.665	0.389	0.361	0.500	0.385	0.050	0.154	1.25
9/16	0.5625	0.562	0.545	0.795	0.748	0.437	0.407	0.454	0.439	0.054	0.167	1.41
5/8	0.6250	0.625	0.606	0.884	0.833	0.485	0.452	0.507	0.492	0.059	0.182	1.56
3/4	0.7500	0.750	0.729	1.060	1.001	0.582	0.544	0.620	0.605	0.065	0.200	1.88
7/8	0.8750	0.875	0.852	1.237	1.170	0.678	0.635	0.731	0.716	0.072	0.222	2.19
1	1.0000	1.000	0.974	1.414	1.337	0.774	0.726	0.838	0.823	0.081	0.250	2.50
1-1/8	1.1250	1.125	1.096	1.591	1.505	0.870	0.817	0.939	0.914	0.092	0.283	2.81
1-1/4	1.2500	1.250	1.219	1.768	1.674	0.966	0.908	1.064	1.039	0.092	0.283	2.12
1-3/8	1.3750	1.375	1.342	1.945	1.843	1.063	1.000	1.159	1.134	0.109	0.333	3.44
1-1/2	1.5000	1.500	1.464	2.121	2.010	1.159	1.091	1.284	1.259	0.109	0.333	3.75

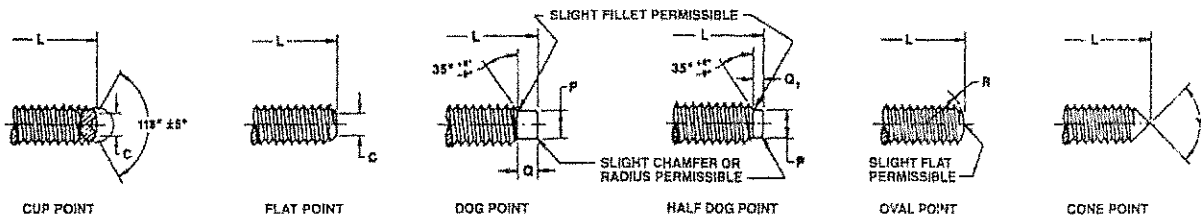

Nominal Size or Basic Screw Diameter	C		P		Q		Q <sub>1</sub>		R	Y	
	Cup and Flat Point Diameters		Dog and Half Dog Point Diameters		Point Length				Oval Point Radius	Cone Point Angle 90° ± 2° For These Nominal Lengths or Longer; 118° ± 2° For Shorter Screws	
	Max	Min	Max	Min	Dog		Half Dog				
10	0.1900	0.102	0.068	0.127	0.120	0.095	0.085	0.050	0.040	0.142	1/4
1/4	0.2500	0.132	0.118	0.156	0.149	0.130	0.120	0.068	0.058	0.188	5/16
5/16	0.3125	0.172	0.156	0.203	0.195	0.161	0.151	0.083	0.073	0.234	3/8
3/8	0.3750	0.212	0.194	0.250	0.241	0.193	0.183	0.099	0.089	0.281	7/16
7/16	0.4365	0.252	0.232	0.297	0.287	0.224	0.214	0.114	0.104	0.328	1/2
1/2	0.5000	0.291	0.270	0.344	0.334	0.255	0.245	0.130	0.120	0.375	9/16
9/16	0.5625	0.332	0.309	0.391	0.379	0.287	0.275	0.146	0.134	0.422	5/8
5/8	0.6250	0.371	0.347	0.469	0.456	0.321	0.305	0.164	0.148	0.469	3/4
3/4	0.7500	0.450	0.425	0.562	0.549	0.383	0.367	0.196	0.180	0.562	7/8
7/8	0.8750	0.530	0.502	0.656	0.642	0.446	0.430	0.227	0.211	0.656	1
1	1.0000	0.609	0.579	0.750	0.734	0.510	0.490	0.260	0.240	0.750	1-1/8
1-1/8	1.1250	0.689	0.655	0.844	0.826	0.572	0.552	0.291	0.271	0.844	1-1/4
1-1/4	1.2500	0.767	0.733	0.938	0.920	0.635	0.615	0.323	0.303	0.938	1-1/2
1-3/8	1.3750	0.848	0.808	1.031	1.011	0.698	0.678	0.354	0.334	1.031	1-5/8
1-1/2	1.5000	0.926	0.886	1.125	1.105	0.760	0.740	0.385	0.365	1.125	1-3/4

# DIMENSIONS OF BUTTON SOCKET HEAD CAP SCREWS

CLASS FIT 3A  
HARDNESS RC 36-43

Slight flat and/or  
countersink  
permissible

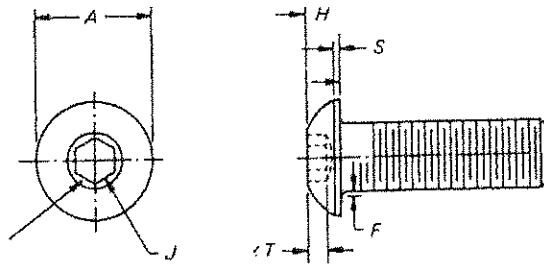

Nominal Size or Basic Screw Diameter	A		H		S	J	T	F		
	Head Diameter		Head Height		Head Side Height	Hexagon Socket Size	Key Engagement	Fillet Extension		
	Max.	Min.	Max.	Min.	Ref.	Nom.	Min.	Max.	Min.	
0	0.0600	0.114	0.104	0.032	0.026	0.010	0.035	0.020	0.010	0.005
1	0.0730	0.139	0.129	0.039	0.033	0.010	0.050	0.028	0.010	0.050
2	0.0860	0.164	0.154	0.046	0.038	0.010	0.050	0.028	0.010	0.050
3	0.0990	0.188	0.176	0.052	0.044	0.010	1/16 0.062	0.035	0.010	0.005
4	0.1120	0.213	0.201	0.059	0.051	0.015	1/16 0.062	0.035	0.010	0.005
5	0.1250	0.238	0.226	0.066	0.058	0.015	5/64 0.078	0.044	0.010	0.005
6	0.1380	0.262	0.250	0.073	0.063	0.015	5/64 0.078	0.044	0.010	0.005
8	0.1640	0.312	0.298	0.087	0.077	0.015	3/32 0.094	0.052	0.015	0.010
10	0.1900	0.361	0.347	0.101	0.091	0.020	1/8 0.125	0.070	0.015	0.010
1/4	0.2500	0.437	0.419	0.132	0.122	0.031	5/32 0.156	0.087	0.020	0.015
5/16	0.3125	0.547	0.527	0.166	0.152	0.031	3/16 0.188	0.105	0.020	0.015
3/8	0.3750	0.656	0.636	0.199	0.185	0.031	7/32 0.219	0.122	0.020	0.015
1/2	0.5000	0.875	0.851	0.265	0.245	0.046	5/16 0.312	0.175	0.030	0.020
5/8	0.6250	1.000	0.970	0.331	0.311	0.062	3/8 0.375	0.210	0.030	0.020

# DIMENSIONS OF DOWEL PINS & PULL DOWEL PINS

SURFACE HARDNESS RC 60 min.  
CORE HARDNESS RD 50-58  
SURFACE FINISH 8 MU max

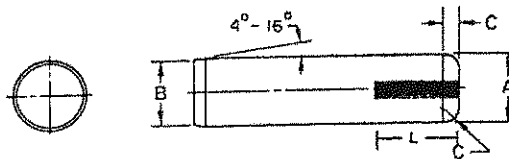

Nominal Size or Nominal Pin Diameter	A						B		C		Double Shear Load Min. lb	L	Tap Size
	Pin Diameter						Point Diameter	Crown Height or Radius	Material Carbon or Alloy Steel				
	Standard Series Pins			Oversize Series Pins						Max	Min	Max	Min
	Basic	Max	Min	Basic	Max	Min							
1/16 0.0625	0.0627	0.0628	0.0626	0.0635	0.0636	0.0634	0.058	0.048	0.020	0.008	800		
5/64 0.0781	0.0783	0.0784	0.0782	0.0791	0.0792	0.0790	0.074	0.064	0.026	0.010	1,240		
3/32 0.0938	0.0940	0.0941	0.0939	0.0948	0.0949	0.0947	0.089	0.079	0.031	0.012	1,800		
1/8 0.1250	0.1252	0.1253	0.1251	0.1260	0.1261	0.1259	0.120	0.110	0.041	0.016	3,200		
5/32 0.1562	0.1564	0.1565	0.1563	0.1572	0.1573	0.1571	0.150	0.140	0.052	0.020	5,000		
3/16 0.1875	0.1877	0.1878	0.1876	0.1885	0.1886	0.1884	0.180	0.170	0.062	0.023	7,200		
1/4 0.2500	0.2502	0.2503	0.2501	0.2510	0.2511	0.2509	0.240	0.230	0.083	0.031	12,800	21/64	6-32
5/16 0.3125	0.3127	0.3128	0.3126	0.3135	0.3136	0.3134	0.302	0.290	0.104	0.039	20,000	21/64	10-32
3/8 0.3750	0.3752	0.3753	0.3751	0.3760	0.3761	0.3759	0.365	0.350	0.125	0.047	28,700	3/8	10-32
7/16 0.4375	0.4377	0.4378	0.4376	0.4385	0.4386	0.4384	0.424	0.409	0.146	0.055	39,100	1/2	1/4-20
1/2 0.5000	0.5002	0.5003	0.5001	0.5010	0.5011	0.5009	0.486	0.471	0.167	0.063	51,000	1/2	1/4-20
5/8 0.6250	0.6252	0.6253	0.6251	0.6260	0.6261	0.6259	0.611	0.595	0.208	0.078	79,800	1/2	1/4-20
3/4 0.7500	0.7502	0.7503	0.7501	0.7510	0.7511	0.7509	0.735	0.715	0.250	0.094	114,000	5/8	5/16-18
7/8 0.8750	0.8752	0.8753	0.8751	0.8760	0.8761	0.8769	0.860	0.840	0.293	0.109	156,000	N/A	N/A
1 1.0000	1.0002	1.0003	1.0001	1.0010	1.0011	1.0009	0.980	0.960	0.333	0.125	204,000	3/4	5/16-18

## DIMENSIONS OF SPRING PINS

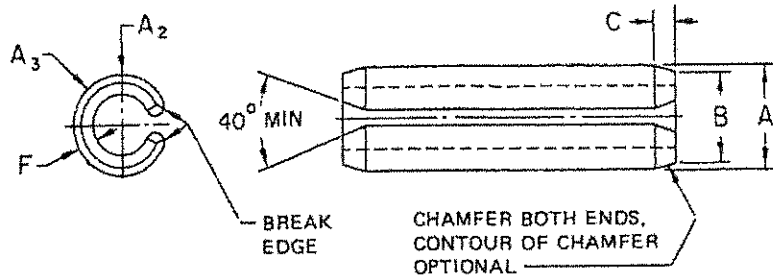

Nominal Size or Basic Pin Diameter	A		B	C		F	Recommended Hole Size		Double Shear Load, Min, lb			
	Pin Diameter		Chamfer Diameter	Chamfer Length		Stock Thickness	Hole Size		Material			
	Max <sup>2</sup>	Min <sup>3</sup>	Max	Max	Min	Basic	Max	Min	AISI 1070-1095 and AISI 420	AISI 302	Beryllium Copper	
1/16	0.062	0.069	0.066	0.059	0.028	0.007	0.012	0.065	0.062	425	350	270
5/64	0.078	0.086	0.083	0.075	0.032	0.008	0.018	0.081	0.078	650	550	400
3/32	0.094	0.103	0.099	0.091	0.038	0.008	0.022	0.097	0.094	1,000	800	660
1/8	0.125	0.135	0.131	0.122	0.044	0.008	0.028	0.129	0.125	2,100	1,500	1,200
9/64	0.141	0.149	0.145	0.137	0.044	0.008	0.028	0.144	0.140	2,200	1,600	1,400
5/32	0.156	0.167	0.162	0.151	0.048	0.010	0.032	0.160	0.156	3,000	2,000	1,800
3/16	0.188	0.199	0.194	0.182	0.055	0.011	0.040	0.192	0.187	4,400	2,800	2,600
7/32	0.219	0.232	0.226	0.214	0.065	0.011	0.048	0.224	0.219	5,700	3,550	3,700
1/4	0.250	0.264	0.258	0.245	0.066	0.012	0.048	0.256	0.250	7,700	4,600	4,500
5/16	0.312	0.328	0.321	0.306	0.080	0.014	0.062	0.318	0.312	11,500	7,095	6,800
3/8	0.375	0.392	0.385	0.368	0.095	0.016	0.077	0.382	0.375	17,600	10,000	10,100
7/16	0.438	0.456	0.448	0.430	0.095	0.017	0.077	0.445	0.437	20,000	12,000	12,200
1/2	0.500	0.521	0.513	0.485	0.110	0.025	0.094	0.510	0.500	25,800	15,500	16,800
5/8	0.625	0.650	0.640	0.608	0.125	0.030	0.125	0.636	0.625	46,000 <sup>4</sup>	18,800	...
3/4	0.750	0.780	0.769	0.730	0.150	0.030	0.150	0.764	0.750	66,000 <sup>4</sup>	23,200	...

## DIMENSIONS OF NYLON & BRASS TIP SET SCREW

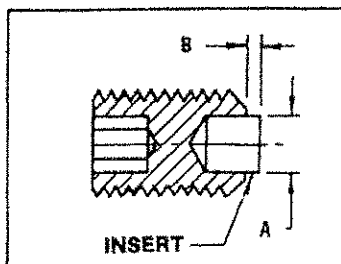

THREAD SIZE	TIP DIAMETER A	TIP PROTRUSION B	THREAD SIZE	TIP DIAMETER A	TIP PROTRUSION B
2-56	1/32	1/32	1/4-28	1/8	1/16
4-40	1/16	1/32	5/16-18	3/16	3/32
6-32	1/16	1/32	5/16-24	3/16	3/32
8-32	3/32	3/64	3/8-16	3/16	3/32
10-24	3/32	3/64	3/8-24	3/16	3/32
10-32	3/32	3/64	1/2-13	1/4	1/8
1/4-20	1/8	1/16	1/2-20	1/4	1/8

# KEY APPLICATION CHART

KEY SIZE (W)		SOCKET HEAD CAP SCREW	BUTTON HEAD SCREW	FLAT HEAD SCREW	SHOULDER SCREW	LOW HEAD AND SOCKET SET	PRESSURE PLUGS
MAX.	MIN.						
.028	.0275	-	-	-	-	#0	-
.035	.0345	-	#0	#0	-	#1, #2	-
.050	.049	#0	#1, #2	#1, #2	-	#3, #4	-
1/16	.0615	#1	#3, #4	#3, #4	-	#5, #6	-
5/64	.0771	#2, #3	#5, #6	#5, #6	-	#8	-
3/32	.0927	#4, #5	#8	#8	-	#10	-
7/64	.1079	#6	-	-	-	-	-
1/8	.1235	-	#10	#10	1/4	1/4	-
9/64	.1391	#8	-	-	-	-	-
5/32	.1547	#10	1/4	1/4	5/16	5/16	1/16
3/16	.1860	1/4	5/16	5/16	3/8	3/8	1/8
7/32	.2172	-	3/8	3/8	-	7/16	-
1/4	.2485	5/16	-	7/16	1/2	1/2	1/4
5/16	.3110	3/8	1/2	1/2, 9/16	5/8	5/8	3/8
3/8	.3735	7/16, 1/2	5/8	5/8	3/4	3/4	1/2
7/16	.4355	9/16	-	-	-	-	-
1/2	.4975	5/8	-	3/4	7/8, 1	7/8	-
9/16	.5600	-	-	7/8	-	1, 1 1/8	3/4
5/8	.6225	3/8	-	1	1 1/4	1 1/4, 1 3/8	1
3/4	.7470	7/8, 1	-	-	-	1 1/2	1 1/4, 1 1/2
7/8	.8720	1 1/8, 1 1/4	-	-	1 1/2	-	-
1	.9970	1 3/8, 1 1/2	-	-	1 3/4	1 3/4, 2	1 1/2, 2
1 1/4	1.243	1 3/4	-	-	2	-	-
1 1/2	1.493	2	-	-	-	-	-
1 3/4	1.743	2 1/4, 2 1/2	-	-	-	-	-
2	1.993	2 3/4	-	-	-	-	-



Tel.: (819) 346-2903 / (888) 345-2903 Fax.: (819) 346-3389  
 Email: [distributeur@boulonsestrie.com](mailto:distributeur@boulonsestrie.com)

**DIMENSIONS DES  
CLÉS HEXAGONALES**

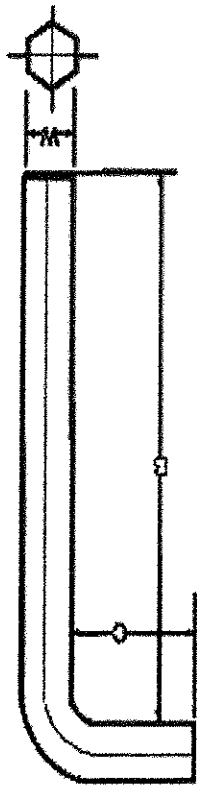

**DIMENSIONS OF  
HEXAGON KEYS**

	W		B		C		MIN. TORSIONAL SHEAR-STRENGTH <sup>1</sup> lb-In	MIN. TORSIONAL YIELD lb-In	MINIMUM TORQUE In-lb
	WRENCH SIZE MAX	MIN	SHORT ARM	NOMINAL LONG ARM	NOMINAL				
.028	.0275	1.219	2.594	.219	1.2	1.1	.86		
.035	.0345	1.219	2.672	.344	2.4	2.1	1.80		
.050	.0490	1.656	2.844	.531	7	6	5.00		
1/16	.0615	1.750	3.000	.562	12	11	9.50		
5/64	.0771	1.875	3.188	.609	26	23	19.40		
3/32	.0927	2.000	3.375	.656	46	40	33.50		
7/64	.1077	2.125	3.562	.703	73	63	52.90		
1/8	.1235	2.250	3.750	.750	108	94	77.90		
9/64	.1391	2.375	3.937	.796	154	134	117.00		
5/32	.1547	2.500	4.125	.844	210	183	156.00		
3/16	.1860	2.750	4.500	.938	364	317	273.00		
7/32	.2172	3.000	4.875	1.031	580	502	428.00		
1/4	.2480	3.250	5.250	1.125	860	750	615.00		
5/16	.3110	3.750	6.000	1.250	1685	1465	1315.00		
3/8	.3730	4.250	6.750	1.375	2900	2520	2150.00		
7/16	.4355	4.750	7.500	1.500	4400	3860	3665.00		
1/2	.4975	5.250	8.250	1.625	6600	5750	5130.00		
9/16	.5600	5.750	9.000	1.750	9200	8000	7010.00		
5/8	.6225	6.250	9.750	1.875	12650	11000	9810.00		
3/4	.7470	7.250	11.250	2.125	20800	18100	15570.00		
7/8	.8720	8.250	12.750	2.375	29200	25400	23400.00		
1	.9970	9.250	14.250	2.625	43700	38000	35100.00		
1 1/4	1.243	11.250	-	3.000	71900	62500	-		
1 1/2	1.493	13.250	-	3.500	124000	108000	-		
1 3/4	1.743	15.250	-	4.000	198000	172000	-		
2	1.993	17.250	-	4.500	276000	240000	-		

VIS À TÊTE CYLINDRIQUE  
À 6 PANS CREUX  
GROS FILETS

NOIR / BARE  
ALLOY STEEL

SOCKET HEAD  
CAP SCREWS  
NATIONAL COARSE

LA FINITION PLAQUÉE ZINC  
EST DISPONIBLE  
SUR DEMANDE

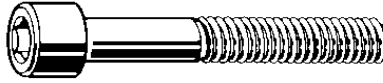

ZINC PLATED IS  
AVAILABLE ON REQUEST

NOTRE CODE	DESCRIPTION	QTÉ/BTE	NOTRE CODE	DESCRIPTION	QTÉ/BTE
OUR CODE	DESCRIPTION	QTY/BOX	OUR CODE	DESCRIPTION	QTY/BOX
*****	1-64 X 3/16	SEMI-STD	SH004002	4-40 X 1/4	100
*****	1-64 X 1/4	SEMI-STD	SH004004	4-40 X 3/8	100
*****	1-64 X 5/16	SEMI-STD	SH004005	4-40 X 1/2	100
*****	1-64 X 3/8	SEMI-STD	SH004006	4-40 X 5/8	100
*****	1-64 X 1/2	SEMI-STD	SH004007	4-40 X 3/4	100
*****	1-64 X 5/8	SEMI-STD	*****	4-40 X 7/8	SEMI-STD
*****	1-64 X 3/4	SEMI-STD	SH004010	4-40 X 1	SEMI-STD
*****	1-64 X 1	SEMI-STD	SH004012	4-40 X 1 1/4	SEMI-STD
*****	2-56 X 1/8	SEMI-STD	SH004015	4-40 X 1 1/2	SEMI-STD
*****	2-56 X 3/16	100	SH005002	5-40 X 1/4	100
*****	2-56 X 1/4	100	SH005004	5-40 X 3/8	100
*****	2-56 X 5/16	SEMI-STD	SH005005	5-40 X 1/2	100
SH002004	2-56 X 3/8	100	SH005006	5-40 X 5/8	100
*****	2-56 X 1/2	100	SH005007	5-40 X 3/4	100
*****	2-56 X 5/8	SEMI-STD	SH005010	5-40 X 1	SEMI-STD
*****	2-56 X 3/4	SEMI-STD	SH005012	5-40 X 1 1/4	SEMI-STD
*****	2-56 X 7/8	SEMI-STD	SH005015	5-40 X 1 1/2	SEMI-STD
*****	2-56 X 1	SEMI-STD	SH005020	5-40 X 2	SEMI-STD
*****	3-48 X 1/8	SEMI-STD	*****	6-32 X 1/8	SEMI-STD
*****	3-48 X 3/16	100	SH006001	6-32 X 3/16	SEMI-STD
*****	3-48 X 1/4	100	SH006002	6-32 X 1/4	100
*****	3-48 X 3/8	100	SH006003	6-32 X 5/16	SEMI-STD
*****	3-48 X 1/2	100	SH006004	6-32 X 3/8	100
*****	3-48 X 5/8	SEMI-STD	*****	6-32 X 7/16	SEMI-STD
*****	3-48 X 3/4	SEMI-STD	SH006005	6-32 X 1/2	100
*****	3-48 X 1	SEMI-STD	*****	6-32 X 9/16	SEMI-STD
*****	4-40 X 1/8	SEMI-STD	SH006006	6-32 X 5/8	100
SH004001	4-40 X 3/16	SEMI-STD	SH006007	6-32 X 3/4	100

SEMI-STD DIFFÉRENTES QUANTITÉS DISPONIBLES/SEMI-STD PACKAGING ANY QUANTITY



Tel.: (819) 346-2903 / (888) 345-2903 Fax.: (819) 346-3389

Email: distributeur@boulonstrie.com

B-1

VIS À TÊTE CYLINDRIQUE  
À 6 PANS CREUX  
GROS FILETS

NOIR / BARE  
ALLOY STEEL

SOCKET HEAD  
CAP SCREWS  
NATIONAL COARSE

LA FINITION PLAQUÉE ZINC  
EST DISPONIBLE  
SUR DEMANDE

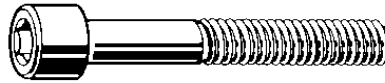

ZINC PLATED IS  
AVAILABLE ON REQUEST

NOTRE CODE	DESCRIPTION	QTÉ/BTE	NOTRE CODE	DESCRIPTION	QTÉ/BTE
OUR CODE	DESCRIPTION	QTY/BOX	OUR CODE	DESCRIPTION	QTY/BOX
SH006008	6-32 X 7/8	100	SH008017	8-32 X 1 3/4	SEMI-STD
SH006010	6-32 X 1	100	SH008020	8-32 X 2	SEMI-STD
*****	6-32 X 1 1/8	SEMI-STD	*****	8-32 X 2 1/4	SEMI-STD
SH006012	6-32 X 1 1/4	SEMI-STD	SH008025	8-32 X 2 1/2	SEMI-STD
*****	6-32 X 1 3/8	SEMI-STD	SH008027	8-32 X 2 3/4	SEMI-STD
SH006015	6-32 X 1 1/2	SEMI-STD	SH008030	8-32 X 3	SEMI-STD
SH006017	6-32 X 1 3/4	SEMI-STD	*****	8-32 X 3 1/4	SEMI-STD
SH006020	6-32 X 2	SEMI-STD	*****	8-32 X 3 1/2	SEMI-STD
*****	6-32 X 2 1/4	SEMI-STD	*****	8-32 X 4	SEMI-STD
SH006025	6-32 X 2 1/2	SEMI-STD	*****	10-24 X 3/16	SEMI-STD
SH006027	6-32 X 2 3/4	SEMI-STD	SH010002	10-24 X 1/4	SEMI-STD
SH006030	6-32 X 3	SEMI-STD	SH010003	10-24 X 5/16	SEMI-STD
*****	8-32 X 1/8	SEMI-STD	SH010004	10-24 X 3/8	100
*****	8-32 X 3/16	SEMI-STD	*****	10-24 X 7/16	100
SH008002	8-32 X 1/4	100	SH010005	10-24 X 1/2	100
*****	8-32 X 5/16	SEMI-STD	SH010006	10-24 X 5/8	100
SH008004	8-32 X 3/8	100	*****	10-24 X 9/16	SEMI-STD
*****	8-32 X 7/16	SEMI-STD	SH010007	10-24 X 3/4	100
SH008005	8-32 X 1/2	100	SH010008	10-24 X 7/8	100
SH008009	8-32 X 9/16	SEMI-STD	SH010010	10-24 X 1	100
SH008006	8-32 X 5/8	100	*****	10-24 X 1 1/8	SEMI-STD
SH008007	8-32 X 3/4	100	SH010012	10-24 X 1 1/4	100
*****	8-32 X 7/8	100	*****	10-24 X 1 3/8	SEMI-STD
SH008010	8-32 X 1	100	SH010015	10-24 X 1 1/2	100
*****	8-32 X 1 1/8	SEMI-STD	SH010016	10-24 X 1 5/8	SEMI-STD
SH008012	8-32 X 1 1/4	100	SH010017	10-24 X 1 3/4	100
*****	8-32 X 1 3/8	SEMI-STD	SH010020	10-24 X 2	100
SH008015	8-32 X 1 1/2	100	*****	10-24 X 2 1/4	SEMI-STD

SEMI-STD DIFFÉRENTES QUANTITÉS DISPONIBLES/SEMI-STD PACKAGING ANY QUANTITY



Tel.: (819) 346-2903 / (888) 345-2903 Fax.: (819) 346-3389

Email: distributeur@boulonsestrie.com

B-2



VIS À TÊTE CYLINDRIQUE  
À 6 PANS CREUX  
GROS FILETS

NOIR / BARE  
ALLOY STEEL

SOCKET HEAD  
CAP SCREWS  
NATIONAL COARSE

LA FINITION PLAQUÉE ZINC  
EST DISPONIBLE  
SUR DEMANDE

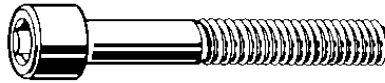

ZINC PLATED IS  
AVAILABLE ON REQUEST

NOTRE CODE	DESCRIPTION	QTÉ/BTE	NOTRE CODE	DESCRIPTION	QTÉ/BTE
OUR CODE	DESCRIPTION	QTY/BOX	OUR CODE	DESCRIPTION	QTY/BOX
*****	10-24 X 2 3/8	SEMI-STD	*****	1/4-20 X 9/16	SEMI-STD
SH010025	10-24 X 2 1/2	SEMI-STD	SH025006	1/4-20 X 5/8	100
SH010027	10-24 X 2 3/4	SEMI-STD	SH025007	1/4-20 X 3/4	100
SH010030	10-24 X 3	SEMI-STD	SH025008	1/4-20 X 7/8	100
SH010032	10-24 X 3 1/4	SEMI-STD	SH025010	1/4-20 X 1	SEMI-STD
SH010035	10-24 X 3 1/2	SEMI-STD	*****	1/4-20 X 1 1/8	SEMI-STD
SH010040	10-24 X 4	SEMI-STD	SH025012	1/4-20 X 1 1/4	100
SH010045	10-24 X 4 1/2	SEMI-STD	*****	1/4-20 X 1 3/8	SEMI-STD
*****	10-24 X 5	SEMI-STD	SH025015	1/4-20 X 1 1/2	100
*****	10-24 X 6	SEMI-STD	*****	1/4-20 X 1 5/8	SEMI-STD
*****	12-24 X 3/8	SEMI-STD	SH025017	1/4-20 X 1 3/4	100
*****	12-24 X 1/2	SEMI-STD	SH025020	1/4-20 X 2	100
*****	12-24 X 5/8	SEMI-STD	SH025022	1/4-20 X 2 1/4	100
*****	12-24 X 3/4	SEMI-STD	*****	1/4-20 X 2 3/8	SEMI-STD
*****	12-24 X 7/8	SEMI-STD	SH025025	1/4-20 X 2 1/2	100
*****	12-24 X 1	SEMI-STD	SH025027	1/4-20 X 2 3/4	100
SH012012	12-24 X 1 1/4	SEMI-STD	SH025030	1/4-20 X 3	100
*****	12-24 X 1 1/2	SEMI-STD	SH025032	1/4-20 X 3 1/4	SEMI-STD
*****	12-24 X 1 3/4	SEMI-STD	SH025035	1/4-20 X 3 1/2	100
*****	12-24 X 2	SEMI-STD	SH025040	1/4-20 X 4	100
*****	12-24 X 2 1/4	SEMI-STD	SH025045	1/4-20 X 4 1/2	SEMI-STD
*****	12-24 X 2 1/2	SEMI-STD	SH025050	1/4-20 X 5	SEMI-STD
SH025002	1/4-20 X 1/4	SEMI-STD	*****	1/4-20 X 5 1/2	SEMI-STD
*****	1/4-20 X 5/16	SEMI-STD	SH025060	1/4-20 X 6	SEMI-STD
SH025004	1/4-20 X 3/8	100	*****	1/4-20 X 6 1/2	SEMI-STD
*****	1/4-20 X 7/16	SEMI-STD	*****	1/4-20 X 7	SEMI-STD
SH025005	1/4-20 X 1/2	100	*****	1/4-20 X 8	SEMI-STD

SEMI-STD DIFFÉRENTES QUANTITÉS DISPONIBLES/SEMI-STD PACKAGING ANY QUANTITY



Tel.: (819) 346-2903 / (888) 345-2903 Fax.: (819) 346-3389

Email: distributeur@boulonsestrie.com

VIS À TÊTE CYLINDRIQUE  
À 6 PANS CREUX  
GROS FILETS

NOIR / BARE  
ALLOY STEEL

SOCKET HEAD  
CAP SCREWS  
NATIONAL COARSE

LA FINITION PLAQUÉE ZINC  
EST DISPONIBLE  
SUR DEMANDE

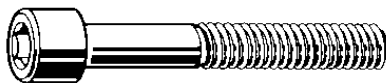

ZINC PLATED IS  
AVAILABLE ON REQUEST

NOTRE CODE	DESCRIPTION	QTÉ/BTE	NOTRE CODE	DESCRIPTION	QTÉ/BTE
OUR CODE	DESCRIPTION	QTY/BOX	OUR CODE	DESCRIPTION	QTY/BOX
SH031004	5/16-18 X 3/8	100	*****	5/16-18 X 8	SEMI-STD
SH031005	5/16-18 X 1/2	100	*****	5/16-18 X 9	SEMI-STD
SH031006	5/16-18 X 5/8	100	*****	5/16-18 X 10	SEMI-STD
SH031007	5/16-18 X 3/4	100	*****	3/8-16 X 3/8	SEMI-STD
SH031008	5/16-18 X 7/8	100	SH037005	3/8-16 X 1/2	100
SH031010	5/16-18 X 1	100	SH037006	3/8-16 X 5/8	100
*****	5/16-18 X 1 1/8	SEMI-STD	SH037007	3/8-16 X 3/4	100
SH031012	5/16-18 X 1 1/4	100	SH037008	3/8-16 X 7/8	100
SH031014	5/16-18 X 1 3/8	SEMI-STD	SH037010	3/8-16 X 1	100
SH031015	5/16-18 X 1 1/2	100	*****	3/8-16 X 1 1/8	SEMI-STD
*****	5/16-18 X 1 5/8	SEMI-STD	SH037012	3/8-16 X 1 1/4	100
SH031017	5/16-18 X 1 3/4	100	SH037013	3/8-16 X 1 3/8	SEMI-STD
SH031020	5/16-18 X 2	100	SH037015	3/8-16 X 1 1/2	100
SH031022	5/16-18 X 2 1/4	100	SH037016	3/8-16 X 1 5/8	SEMI-STD
SH031025	5/16-18 X 2 1/2	100	SH037017	3/8-16 X 1 3/4	100
SH031027	5/16-18 X 2 3/4	100	SH037020	3/8-16 X 2	100
SH031030	5/16-18 X 3	100	SH037022	3/8-16 X 2 1/4	100
SH031032	5/16-18 X 3 1/4	100	SH037025	3/8-16 X 2 1/2	50
SH031035	5/16-18 X 3 1/2	100	SH037027	3/8-16 X 2 3/4	50
SH031037	5/16-18 X 3 3/4	SEMI-STD	SH037028	3/8-16 X 2 7/8	SEMI-STD
SH031040	5/16-18 X 4	100	SH037030	3/8-16 X 3	50
SH031045	5/16-18 X 4 1/2	SEMI-STD	SH037032	3/8-16 X 3 1/4	50
SH031050	5/16-18 X 5	SEMI-STD	SH037035	3/8-16 X 3 1/2	50
SH031055	5/16-18 X 5 1/2	SEMI-STD	SH037037	3/8-16 X 3 3/4	SEMI-STD
SH031060	5/16-18 X 6	SEMI-STD	SH037040	3/8-16 X 4	50
*****	5/16-18 X 6 1/2	SEMI-STD	SH037042	3/8-16 X 4 1/4	50
SH031070	5/16-18 X 7	SEMI-STD	SH037045	3/8-16 X 4 1/2	50

SEMI-STD DIFFÉRENTES QUANTITÉS DISPONIBLES/SEMI-STD PACKAGING ANY QUANTITY



Tel.: (819) 346-2903 / (888) 345-2903 Fax.: (819) 346-3389

Email: distributeur@boulonsestrie.com

VIS À TÊTE CYLINDRIQUE  
À 6 PANS CREUX  
GROS FILETS

NOIR / BARE  
ALLOY STEEL

SOCKET HEAD  
CAP SCREWS  
NATIONAL COARSE

LA FINITION PLAQUÉE ZINC  
EST DISPONIBLE  
SUR DEMANDE

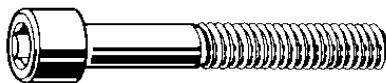

ZINC PLATED IS  
AVAILABLE ON REQUEST

NOTRE CODE	DESCRIPTION	QTÉ/BTE	NOTRE CODE	DESCRIPTION	QTÉ/BTE
OUR CODE	DESCRIPTION	QTY/BOX	OUR CODE	DESCRIPTION	QTY/BOX
*****	3/8-16 X 4 3/4	SEMI-STD	SH043050	7/16-14 X 5	SEMI-STD
SH037050	3/8-16 X 5	50	*****	7/16-14 X 5 1/2	SEMI-STD
SH037055	3/8-16 X 5 1/2	SEMI-STD	SH043060	7/16-14 X 6	SEMI-STD
SH037060	3/8-16 X 6	50	*****	1/2-13 X 3/8	SEMI-STD
SH037065	3/8-16 X 6 1/2	SEMI-STD	SH050005	1/2-13 X 1/2	50
SH037070	3/8 X 7	SEMI-STD	SH050006	1/2-13 X 5/8	50
SH037075	3/8-16 X 7 1/2	SEMI-STD	SH050007	1/2-13 X 3/4	50
SH037080	3/8-16 X 8	SEMI-STD	SH050008	1/2-13 X 7/8	50
*****	3/8-16 X 9	SEMI-STD	SH050010	1/2-13 X 1	50
SH037100	3/8-16 X 10	SEMI-STD	*****	1/2-13 X 1 1/8	SEMI-STD
SH043005	7/16-14 X 1/2	100	SH050012	1/2-13 X 1 1/4	50
SH043006	7/16-14 X 5/8	100	*****	1/2-13 X 1 3/8	SEMI-STD
SH043007	7/16-14 X 3/4	100	SH050015	1/2-13 X 1 1/2	50
SH043008	7/16-14 X 7/8	100	*****	1/2-13 X 1 5/8	SEMI-STD
SH043010	7/16-14 X 1	100	SH050017	1/2-13 X 1 3/4	50
SH043012	7/16-14 X 1 1/4	100	SH050020	1/2-13 X 2	50
SH043015	7/16-14 X 1 1/2	100	SH050022	1/2-13 X 2 1/4	50
SH043017	7/16-14 X 1 3/4	100	SH050025	1/2-13 X 2 1/2	50
SH043020	7/16-14 X 2	50	SH050027	1/2-13 X 2 3/4	50
SH043022	7/16-14 X 2 1/4	50	SH050030	1/2-13 X 3	50
SH043025	7/16-14 X 2 1/2	50	SH050032	1/2-13 X 3 1/4	25
SH043027	7/16-14 X 2 3/4	50	SH050035	1/2-13 X 3 1/2	25
SH043030	7/16-14 X 3	50	SH050037	1/2-13 X 3 3/4	SEMI-STD
SH043032	7/16-14 X 3 1/4	50	SH050040	1/2-13 X 4	25
SH043035	7/16-40 X 3 1/2	50	SH050042	1/2-13 X 4 1/4	SEMI-STD
SH043040	7/16-14 X 4	50	SH050045	1/2-13 X 4 1/2	25
SH043045	7/16-14 X 4 1/2	SEMI-STD	SH050047	1/2-13 X 4 3/4	SEMI-STD

SEMI-STD DIFFÉRENTES QUANTITÉS DISPONIBLES/SEMI-STD PACKAGING ANY QUANTITY



Tel.: (819) 346-2903 / (888) 345-2903 Fax.: (819) 346-3389

Email: distributeur@boulonsestrie.com

VIS À TÊTE CYLINDRIQUE  
 À 6 PANS CREUX  
 GROS FILETS

NOIR / BARE  
 ALLOY STEEL

SOCKET HEAD  
 CAP SCREWS  
 NATIONAL COARSE

LA FINITION PLAQUÉE ZINC  
 EST DISPONIBLE  
 SUR DEMANDE

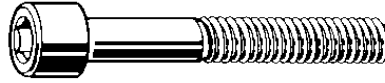

ZINC PLATED IS  
 AVAILABLE ON REQUEST

NOTRE CODE	DESCRIPTION	QTÉ/BTE	NOTRE CODE	DESCRIPTION	QTÉ/BTE
OUR CODE	DESCRIPTION	QTY/BOX	OUR CODE	DESCRIPTION	QTY/BOX
SH050050	1/2-13 X 5	25	*****	9/16-12 X 4	SEMI-STD
SH050052	1/2-13 X 5 1/4	SEMI-STD	*****	9/16-12 X 4 1/2	SEMI-STD
SH050055	1/2-13 X 5 1/2	25	*****	9/16-12 X 5	SEMI-STD
SH050060	1/2-13 X 6	25	*****	9/16-12 X 5 1/2	SEMI-STD
SH050065	1/2-13 X 6 1/2	10	*****	9/16-12 X 6	SEMI-STD
SH050070	1/2-13 X 7	10	*****	9/16-12 X 6 1/2	SEMI-STD
SH050075	1/2-13 X 7 1/2	SEMI-STD	*****	9/16-12 X 7	SEMI-STD
SH050080	1/2-13 X 8	10	*****	9/16-12 X 7 1/2	SEMI-STD
SH050085	1/2-13 X 8 1/2	SEMI-STD	*****	9/16-12 X 8	SEMI-STD
SH050090	1/2-13 X 9	SEMI-STD	SH062006	5/8-11 X 5/8	SEMI-STD
*****	1/2-13 X 9 1/2	SEMI-STD	*****	5/8-11 X 3/4	SEMI-STD
SH050100	1/2-13 X 10	SEMI-STD	*****	5/8-11 X 7/8	SEMI-STD
SH050110	1/2-13 X 11	SEMI-STD	SH062010	5/8-11 X 1	50
SH050120	1/2-13 X 12	SEMI-STD	SH062012	5/8-11 X 1 1/4	50
*****	1/2-13 X 14	SEMI-STD	*****	5/8-11 X 1 3/8	SEMI-STD
*****	1/2-13 X 15	SEMI-STD	SH062015	5/8-11 X 1 1/2	50
*****	1/2-13 X 16	SEMI-STD	SH062017	5/8-11 X 1 3/4	SEMI-STD
*****	9/16-12 X 1	SEMI-STD	SH062020	5/8-11 X 2	50
SH056012	9/16-12 X 1 1/4	SEMI-STD	SH062022	5/8-11 X 2 1/4	25
SH056015	9/16-12 X 1 1/2	SEMI-STD	SH062025	5/8-11 X 2 1/2	25
SH056017	9/16-12 X 1 3/4	SEMI-STD	SH062027	5/8-11 X 2 3/4	25
*****	9/16-12 X 2	SEMI-STD	SH062030	5/8-11 X 3	25
*****	9/16-12 X 2 1/4	SEMI-STD	SH062032	5/8-11 X 3 1/4	25
*****	9/16-12 X 2 1/2	SEMI-STD	SH062035	5/8-11 X 3 1/2	25
*****	9/16-12 X 2 3/4	SEMI-STD	SH062037	5/8-11 X 3 3/4	25
*****	9/16-12 X 3	SEMI-STD	SH062040	5/8-11 X 4	25
*****	9/16-12 X 3 1/2	SEMI-STD	SH062042	5/8-11 X 4 1/4	SEMI-STD

SEMI-STD DIFFÉRENTES QUANTITÉS DISPONIBLES/SEMI-STD PACKAGING ANY QUANTITY



Tel.: (819) 346-2903 / (888) 345-2903 Fax.: (819) 346-3389

Email: distributeur@boulonsestrie.com

VIS À TÊTE CYLINDRIQUE  
À 6 PANS CREUX  
GROS FILETS

NOIR / BARE  
ALLOY STEEL

SOCKET HEAD  
CAP SCREWS  
NATIONAL COARSE

LA FINITION PLAQUÉE ZINC  
EST DISPONIBLE  
SUR DEMANDE

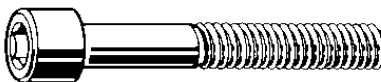

ZINC PLATED IS  
AVAILABLE ON REQUEST

NOTRE CODE	DESCRIPTION	QTÉ/BTE	NOTRE CODE	DESCRIPTION	QTÉ/BTE
OUR CODE	DESCRIPTION	QTY/BOX	OUR CODE	DESCRIPTION	QTY/BOX
SH062045	5/8-11 X 4 1/2	25	SH075035	3/4-10 X 3 1/2	25
SH062050	5/8-11 X 5	25	SH075037	3/4-10 X 3 3/4	SEMI-STD
SH062055	5/8-11 X 5 1/2	10	SH075040	3/4-10 X 4	25
SH062060	5/8-11 X 6	10	*****	3/4-10 X 4 1/4	SEMI-STD
SH062065	5/8-11 X 6 1/2	10	SH075045	3/4-10 X 4 1/2	25
SH062070	5/8-11 X 7	10	*****	3/4-10 X 4 3/4	SEMI-STD
*****	5/8-11 X 7 1/2	SEMI-STD	SH075050	3/4-10 X 5	25
SH062080	5/8-11 X 8	10	SH075055	3/4-10 X 5 1/2	10
*****	5/8-11 X 8 1/2	SEMI-STD	SH075060	3/4-10 X 6	10
*****	5/8-11 X 9	SEMI-STD	SH075065	3/4-10 X 6 1/2	10
*****	5/8-11 X 9 1/2	SEMI-STD	SH075070	3/4-10 X 7	10
*****	5/8-11 X 10	SEMI-STD	SH075080	3/4-10 X 8	10
*****	5/8-11 X 11	SEMI-STD	*****	3/4-10 X 8 1/2	SEMI-STD
SH062120	5/8-11 X 12	SEMI-STD	SH075090	3/4-10 X 9	10
*****	5/8-11 X 14	SEMI-STD	*****	3/4-10 X 10	SEMI-STD
*****	5/8-11 X 15	SEMI-STD	*****	3/4-10 X 11	SEMI-STD
*****	5/8-11 X 16	SEMI-STD	*****	3/4-10 X 12	SEMI-STD
SH075010	3/4-10 X 1	SEMI-STD	*****	3/4-10 X 13	SEMI-STD
SH075012	3/4-10 X 1 1/4	25	*****	3/4-10 X 14	SEMI-STD
SH075015	3/4-10 X 1 1/2	25	*****	3/4-10 X 15	SEMI-STD
SH075017	3/4-10 X 1 3/4	25	*****	3/4-10 X 16	SEMI-STD
SH075020	3/4-10 X 2	25	*****	3/4-10 X 18	SEMI-STD
SH075022	3/4-10 X 2 1/4	25	*****	3/4-10 X 20	SEMI-STD
SH075025	3/4-10 X 2 1/2	25	*****	7/8-9 X 1 1/4	SEMI-STD
SH075027	3/4-10 X 2 3/4	25	*****	7/8-9 X 1 1/2	SEMI-STD
SH075030	3/4-10 X 3	25	*****	7/8-9 X 1 3/4	SEMI-STD
SH075032	3/4-10 X 3 1/4	25	SH087020	7/8-9 X 2	10

SEMI-STD DIFFÉRENTES QUANTITÉS DISPONIBLES/SEMI-STD PACKAGING ANY QUANTITY



Tel.: (819) 346-2903 / (888) 345-2903 Fax.: (819) 346-3389

Email: distributeur@boulonsestrie.com

B-7

VIS À TÊTE CYLINDRIQUE  
À 6 PANS CREUX  
GROS FILETS

NOIR / BARE  
ALLOY STEEL

SOCKET HEAD  
CAP SCREWS  
NATIONAL COARSE

LA FINITION PLAQUÉE ZINC  
EST DISPONIBLE  
SUR DEMANDE

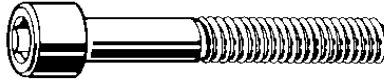

ZINC PLATED IS  
AVAILABLE ON REQUEST

NOTRE CODE	DESCRIPTION	QTÉ/BTE	NOTRE CODE	DESCRIPTION	QTÉ/BTE
OUR CODE	DESCRIPTION	QTY/BOX	OUR CODE	DESCRIPTION	QTY/BOX
SH087022	7/8-9 X 2 1/4	10	SH090022	1-8 X 2 1/4	10
SH087025	7/8-9 X 2 1/2	10	SH090025	1-8 X 2 1/2	10
*****	7/8-9 X 2 3/4	SEMI-STD	SH090027	1-8 X 2 3/4	10
SH087030	7/8-9 X 3	10	SH090030	1-8 X 3	10
*****	7/8-9 X 3 1/4	SEMI-STD	*****	1-8 X 3 1/4	10
SH087035	7/8-9 X 3 1/2	10	SH090035	1-8 X 3 1/2	10
SH087040	7/8-9 X 4	10	SH090037	1-8 X 3 3/4	SEMI-STD
SH087045	7/8-9 X 4 1/2	10	SH090040	1-8 X 4	10
*****	7/8-9 X 4 3/4	SEMI-STD	*****	1-8 X 4 1/4	SEMI-STD
SH087050	7/8-9 X 5	10	SH090045	1-8 X 4 1/2	10
SH087055	7/8-9 X 5 1/2	10	*****	1-8 X 4 3/4	SEMI-STD
SH087060	7/8-9 X 6	10	SH090050	1-8 X 5	10
SH087065	7/8-9 X 6 1/2	10	SH090055	1-8 X 5 1/2	10
*****	7/8-9 X 7	10	SH090060	1-8 X 6	10
*****	7/8-9 X 7 1/2	SEMI-STD	SH090065	1-8 X 6 1/2	10
SH087080	7/8-9 X 8	10	SH090070	1-8 X 7	10
*****	7/8-9 X 9	SEMI-STD	*****	1-8 X 7 1/2	SEMI-STD
*****	7/8-9 X 10	SEMI-STD	*****	1-8 X 8	10
*****	7/8-9 X 11	SEMI-STD	*****	1-8 X 8 1/2	SEMI-STD
*****	7/8-9 X 12	SEMI-STD	*****	1-8 X 9	SEMI-STD
*****	7/8-9 X 14	SEMI-STD	*****	1-8 X 9 1/2	SEMI-STD
*****	7/8-9 X 16	SEMI-STD	*****	1-8 X 10	SEMI-STD
*****	7/8-9 X 18	SEMI-STD	*****	1-8 X 10 1/2	SEMI-STD
*****	7/8-9 X 20	SEMI-STD	*****	1-8 X 11	SEMI-STD
SH090015	1-8 X 1 1/2	SEMI-STD	*****	1-8 X 12	SEMI-STD
*****	1-8 X 1 3/4	SEMI-STD	*****	1-8 X 13	SEMI-STD
SH090020	1-8 X 2	10	*****	1-8 X 14	SEMI-STD

SEMI-STD DIFFÉRENTES QUANTITÉS DISPONIBLES/SEMI-STD PACKAGING ANY QUANTITY



Tel.: (819) 346-2903 / (888) 345-2903 Fax.: (819) 346-3389

Email: distributeur@boulonsestrie.com

VIS À TÊTE CYLINDRIQUE  
À 6 PANS CREUX  
GROS FILETS

NOIR / BARE  
ALLOY STEEL

SOCKET HEAD  
CAP SCREWS  
NATIONAL COARSE

LA FINITION PLAQUÉE ZINC  
EST DISPONIBLE  
SUR DEMANDE

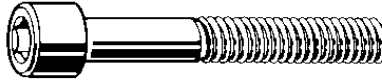

ZINC PLATED IS  
AVAILABLE ON REQUEST

NOTRE CODE	DESCRIPTION	QTÉ/BTE	NOTRE CODE	DESCRIPTION	QTÉ/BTE
OUR CODE	DESCRIPTION	QTY/BOX	OUR CODE	DESCRIPTION	QTY/BOX
*****	1-8 X 16	SEMI-STD	SH092035	1 1/4-7 X 3 1/2	1
*****	1-8 X 18	SEMI-STD	*****	1 1/4-7 X 3 3/4	SEMI-STD
*****	1-8 X 20	SEMI-STD	SH092040	1 1/4-7 X 4	1
*****	1 1/8-7 X 2	SEMI-STD	SH092045	1 1/4-7 X 4 1/2	1
*****	1 1/8-7 X 2 1/2	SEMI-STD	*****	1 1/4-7 X 5	1
*****	1 1/8-7 X 3	SEMI-STD	SH092055	1 1/4-7 X 5 1/2	1
SH091035	1 1/8-7 X 3 1/2	SEMI-STD	*****	1 1/4-7 X 6	1
SH091040	1 1/8-7 X 4	SEMI-STD	*****	1 1/4-7 X 6 1/2	1
*****	1 1/8-7 X 4 1/2	SEMI-STD	*****	1 1/4-7 X 7	1
SH091050	1 1/8-7 X 5	SEMI-STD	*****	1 1/4-7 X 8	1
*****	1 1/8-7 X 5 1/2	SEMI-STD	*****	1 1/4-7 X 9	1
*****	1 1/8-7 X 6	SEMI-STD	*****	1 1/4-7 X 10	1
*****	1 1/8-7 X 7	SEMI-STD	*****	1 1/4-7 X 11	SEMI-STD
*****	1 1/8-7 X 8	SEMI-STD	*****	1 1/4-7 X 12	1
*****	1 1/8-7 X 9	SEMI-STD	*****	1 1/4-7 X 13	SEMI-STD
*****	1 1/8-7 X 10	SEMI-STD	*****	1 1/4-7 X 14	SEMI-STD
*****	1 1/8-7 X 11	SEMI-STD	*****	1 1/4-7 X 15	SEMI-STD
*****	1 1/8-7 X 12	SEMI-STD	*****	1 1/4-7 X 16	SEMI-STD
*****	1 1/8-7 X 13	SEMI-STD	*****	1 1/4-7 X 18	SEMI-STD
*****	1 1/8-7 X 14	SEMI-STD	*****	1 1/4-7 X 20	SEMI-STD
*****	1 1/8-7 X 15	SEMI-STD	*****	1 3/8-6 X 3	SEMI-STD
*****	1 1/8-7 X 16	SEMI-STD	*****	1 3/8-6 X 3 1/2	SEMI-STD
*****	1 1/4-7 X 2	SEMI-STD	*****	1 3/8-6 X 4	SEMI-STD
*****	1 1/4-7 X 2 1/4	SEMI-STD	*****	1 3/8-6 X 4 1/2	SEMI-STD
SH092025	1 1/4-7 X 2 1/2	1	*****	1 3/8-6 X 5	SEMI-STD
*****	1 1/4-7 X 2 3/4	SEMI-STD	*****	1 3/8-6 X 5 1/2	SEMI-STD
SH092030	1 1/4-7 X 3	1	*****	1 3/8-6 X 6	SEMI-STD

SEMI-STD DIFFÉRENTES QUANTITÉS DISPONIBLES/SEMI-STD PACKAGING ANY QUANTITY



Tel.: (819) 346-2903 / (888) 345-2903 Fax.: (819) 346-3389

Email: distributeur@boulonstrie.com

VIS À TÊTE CYLINDRIQUE  
À 6 PANS CREUX  
GROS FILETS

NOIR / BARE  
ALLOY STEEL

SOCKET HEAD  
CAP SCREWS  
NATIONAL COARSE

LA FINITION PLAQUÉE ZINC  
EST DISPONIBLE  
SUR DEMANDE

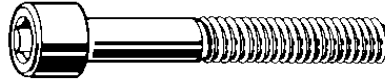

ZINC PLATED IS  
AVAILABLE ON REQUEST

NOTRE CODE	DESCRIPTION	QTÉ/BTE	NOTRE CODE	DESCRIPTION	QTÉ/BTE
OUR CODE	DESCRIPTION	QTY/BOX	OUR CODE	DESCRIPTION	QTY/BOX
*****	1 3/8-6 X 7	SEMI-STD	*****	1 1/2-6 X 16	SEMI-STD
*****	1 3/8-6 X 8	SEMI-STD	*****	1 1/2-6 X 18	SEMI-STD
*****	1 3/8-6 X 10	SEMI-STD	*****	1 1/2-6 X 20	SEMI-STD
*****	1 3/8-6 X 11	SEMI-STD	*****	1 3/4-5 X 3	SEMI-STD
*****	1 3/8-6 X 12	SEMI-STD	*****	1 3/4-5 X 3 1/2	SEMI-STD
*****	1 3/8-6 X 14	SEMI-STD	*****	1 3/4-5 X 4	SEMI-STD
*****	1 3/8-6 X 16	SEMI-STD	*****	1 3/4-5 X 4 1/2	SEMI-STD
*****	1 3/8-6 X 18	SEMI-STD	*****	1 3/4-5 X 5	SEMI-STD
*****	1 3/8-6 X 20	SEMI-STD	*****	1 3/4-5 X 5 1/2	SEMI-STD
*****	1 1/2-6 X 2 1/2	SEMI-STD	*****	1 3/4-5 X 6	SEMI-STD
*****	1 1/2-6 X 2 3/4	SEMI-STD	SH097070	1 3/4-5 X 7	SEMI-STD
SH095030	1 1/2-6 X 3	1	*****	1 3/4-5 X 8	SEMI-STD
*****	1 1/2-6 X 3 1/2	1	*****	1 3/4-5 X 9	SEMI-STD
SH095040	1 1/2-6 X 4	1	*****	1 3/4-5 X 10	SEMI-STD
*****	1 1/2-6 X 4 1/2	1	*****	1 3/4-5 X 12	SEMI-STD
SH095050	1 1/2-6 X 5	1	*****	1 3/4-5 X 14	SEMI-STD
*****	1 1/2-6 X 5 1/2	1	*****	1 3/4-5 X 15	SEMI-STD
*****	1 1/2-6 X 6	1	*****	1 3/4-5 X 16	SEMI-STD
*****	1 1/2-6 X 6 1/2	1	*****	1 3/4-5 X 18	SEMI-STD
*****	1 1/2-6 X 7	1	*****	1 3/4-5 X 20	SEMI-STD
*****	1 1/2-6 X 8	1	*****	2 1/2-4 X 4	SEMI-STD
*****	1 1/2-6 X 9	1	*****	2 1/2-4 X 4 1/2	SEMI-STD
*****	1 1/2-6 X 10	1	*****	2 1/2-4 X 5	SEMI-STD
*****	1 1/2-6 X 11	SEM-STD	*****	2 1/2-4 X 5 1/2	SEMI-STD
*****	1 1/2-6 X 12	1	*****	2 1/2-4 X 6	SEMI-STD
*****	1 1/2-6 X 13	SEMI-STD	*****	2 1/2-4 X 7	SEMI-STD
*****	1 1/2-6 X 14	SEMI-STD	*****	2 1/2-4 X 8	SEMI-STD
*****	1 1/2-6 X 15	SEMI-STD	*****	...	SEMI-STD

SEMI-STD DIFFÉRENTES QUANTITÉS DISPONIBLES/SEMI-STD PACKAGING ANY QUANTITY



Tel.: (819) 346-2903 / (888) 345-2903 Fax.: (819) 346-3389

Email: distributeur@boulonstrie.com



VIS À TÊTE CYLINDRIQUE  
À 6 PANS CREUX  
FILETS FINS

NOIR / BARE  
ALLOY STEEL

SOCKET HEAD  
CAP SCREWS  
NATIONAL FINE

LA FINITION PLAQUÉE ZINC  
EST DISPONIBLE  
SUR DEMANDE



ZINC PLATED IS  
AVAILABLE ON REQUEST

NOTRE CODE	DESCRIPTION	QTÉ/BTE	NOTRE CODE	DESCRIPTION	QTÉ/BTE
OUR CODE	DESCRIPTION	QTY/BOX	OUR CODE	DESCRIPTION	QTY/BOX
*****	0-80 X 1/8	100	*****	3-56 X 5/16	SEMI-STD
*****	0-80 X 3/16	100	*****	3-56 X 3/8	SEMI-STD
*****	0-80 X 1/4	100	*****	3-56 X 1/2	SEMI-STD
*****	0-80 X 5/16	SEMI-STD	*****	3-56 X 5/8	SEMI-STD
*****	0-80 X 3/8	100	*****	3-56 X 3/4	SEMI-STD
*****	0-80 X 1/2	SEMI-STD	*****	3-56 X 1	SEMI-STD
*****	0-80 X 5/8	SEMI-STD	*****	4-48 X 1/8	SEMI-STD
*****	0-80 X 3/4	SEMI-STD	*****	4-48 X 3/16	SEMI-STD
*****	0-80 X 1	SEMI-STD	*****	4-48 X 1/4	SEMI-STD
SH101001	1-72 X 1/8	100	*****	4-48 X 5/16	SEMI-STD
*****	1-72 X 3/16	100	*****	4-48 X 3/8	SEMI-STD
*****	1-72 X 1/4	100	*****	4-48 X 7/16	SEMI-STD
*****	1-72 X 3/8	100	*****	4-48 X 1/2	SEMI-STD
*****	1-72 X 1/2	SEMI-STD	*****	4-48 X 5/8	SEMI-STD
*****	1-72 X 5/8	SEMI-STD	*****	4-48 X 3/4	SEMI-STD
SH101007	1-72 X 3/4	SEMI-STD	*****	4-48 X 7/8	SEMI-STD
*****	1-72 X 1	SEMI-STD	*****	4-48 X 1	SEMI-STD
*****	2-64 X 1/8	SEMI-STD	SH105002	5-44 X 1/4	SEMI-STD
*****	2-64 X 3/16	SEMI-STD	*****	5-44 X 3/8	SEMI-STD
*****	2-64 X 1/4	SEMI-STD	SH105005	5-44 X 1/2	SEMI-STD
*****	2-64 X 3/8	SEMI-STD	*****	5-44 X 5/8	SEMI-STD
*****	2-64 X 1/2	SEMI-STD	*****	5-44 X 3/4	SEMI-STD
*****	2-64 X 5/8	SEMI-STD	*****	6-40 X 3/16	SEMI-STD
*****	2-64 X 3/4	SEMI-STD	SH106002	6-40 X 1/4	100
*****	2-64 X 1	SEMI-STD	*****	6-40 X 5/16	SEMI-STD
*****	3-56 X 1/8	SEMI-STD	SH106004	6-40 X 3/8	100
*****	3-56 X 3/16	SEMI-STD	*****	6-40 X 7/16	SEMI-STD
*****	3-56 X 1/4	SEMI-STD	SH106005	6-40 X 1/2	100

SEMI-STD DIFFÉRENTES QUANTITÉS DISPONIBLES/SEMI-STD PACKAGING ANY QUANTITY



Tel.: (819) 346-2903 / (888) 345-2903 Fax.: (819) 346-3389  
Email: distributeur@boulonstrie.com

VIS À TÊTE CYLINDRIQUE  
À 6 PANS CREUX  
FILETS FINS

NOIR / BARE  
ALLOY STEEL

SOCKET HEAD  
CAP SCREWS  
NATIONAL FINE

LA FINITION PLAQUÉE ZINC  
EST DISPONIBLE  
SUR DEMANDE

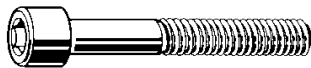

ZINC PLATED IS  
AVAILABLE ON REQUEST

NOTRE CODE	DESCRIPTION	QTÉ/BTE	NOTRE CODE	DESCRIPTION	QTÉ/BTE
OUR CODE	DESCRIPTION	QTY/BOX	OUR CODE	DESCRIPTION	QTY/BOX
SH106006	6-40 X 5/8	100	*****	10-32 X 1 5/8	SEMI-STD
SH106007	6-40 X 3/4	100	SH111017	10-32 X 1 3/4	100
*****	6-40 X 7/8	SEMI-STD	SH111020	10-32 X 2	100
*****	6-40 X 1	SEMI-STD	SH111022	10-32 X 2 1/4	100
*****	8-36 X 1/4	SEMI-STD	*****	10-32 X 2 3/8	SEMI-STD
*****	8-36 X 3/8	100	SH111025	10-32 X 2 1/2	SEMI-STD
SH108005	8-36 X 1/2	100	SH111027	10-32 X 2 3/4	SEMI-STD
*****	8-36 X 5/8	SEMI-STD	SH111030	10-32 X 3	SEMI-STD
*****	8-36 X 3/4	100	SH111032	10-32 X 3 1/4	SEMI-STD
*****	8-36 X 7/8	SEMI-STD	SH111035	10-32 X 3 1/2	SEMI-STD
*****	8-36 X 1	SEMI-STD	SH111045	10-32 X 4 1/2	SEMI-STD
*****	8-36 X 1 1/4	SEMI-STD	*****	10-32 X 5	SEMI-STD
*****	8-36 X 1 1/2	SEMI-STD	*****	10-32 X 6	SEMI-STD
*****	10-32 X 3/16	SEMI-STD	*****	12-28 X 3/8	SEMI-STD
SH111002	10-32 X 1/4	SEMI-STD	*****	12-28 X 1/2	SEMI-STD
*****	10-32 X 5/16	SEMI-STD	*****	12-28 X 5/8	SEMI-STD
SH111004	10-32 X 3/8	100	*****	12-28 X 3/4	SEMI-STD
*****	10-32 X 7/16	SEMI-STD	*****	12-28 X 1	SEMI-STD
SH111005	10-32 X 1/2	100	*****	12-28 X 1 1/4	SEMI-STD
*****	10-32 X 9/16	SEMI-STD	*****	12-28 X 1 1/2	SEMI-STD
SH111006	10-32 X 5/8	100	SH125002	1/4-28 X 1/4	SEMI-STD
SH111007	10-32 X 3/4	100	SH125003	1/4-28 X 3/8	100
SH111008	10-32 X 7/8	100	*****	1/4-28 X 7/16	SEMI-STD
SH111010	10-32 X 1	100	SH125005	1/4-28 X 1/2	100
*****	10-32 X 1 1/8	SEMI-STD	*****	1/4-28 X 9/16	SEMI-STD
SH111012	10-32 X 1 1/4	100	SH125006	1/4-28 X 5/8	100
*****	10-32 X 1 3/8	SEMI-STD	SH125007	1/4-28 X 3/4	100
SH111015	10-32 X 1 1/2	SEMI-STD	SH125008	1/4-28 X 7/8	100

SEMI-STD DIFFÉRENTES QUANTITÉS DISPONIBLES/SEMI-STD PACKAGING ANY QUANTITY



Tel.: (819) 346-2903 / (888) 345-2903 Fax.: (819) 346-3389  
Email: distributeur@boulonstrie.com

VIS À TÊTE CYLINDRIQUE  
À 6 PANS CREUX  
FILETS FINS

NOIR / BARE  
ALLOY STEEL

SOCKET HEAD  
CAP SCREWS  
NATIONAL FINE

LA FINITION PLAQUÉE ZINC  
EST DISPONIBLE  
SUR DEMANDE

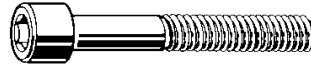

ZINC PLATED IS  
AVAILABLE ON REQUEST

NOTRE CODE	DESCRIPTION	QTÉ/BTE	NOTRE CODE	DESCRIPTION	QTÉ/BTE
OUR CODE	DESCRIPTION	QTY/BOX	OUR CODE	DESCRIPTION	QTY/BOX
SH125010	1/4-28 X 1	100	*****	5/16-24 X 5	SEMI-STD
*****	1/4-28 X 1 1/8	SEMI-STD	*****	5/16-24 X 5 1/2	SEMI-STD
SH125012	1/4-28 X 1 1/4	100	*****	5/16-24 X 6	SEMI-STD
*****	1/4-28 X 1 3/8	SEMI-STD	*****	3/8-24 X 3/8	SEMI-STD
SH125015	1/4-28 X 1 1/2	100	SH137005	3/8-24 X 1/2	100
SH125017	1/4-28 X 1 3/4	100	*****	3/8-24 X 5/8	100
SH125020	1/4-28 X 2	100	SH137007	3/8-24 X 3/4	100
SH125022	1/4-28 X 2 1/4	100	*****	3/8-24 X 7/8	100
SH125025	1/4-28 X 2 1/2	SEMI-STD	SH137010	3/8-24 X 1	100
SH125035	1/4-28 X 3 1/2	100	*****	3/8-24 X 1 1/8	SEMI-STD
*****	5/16-24 X 3/8	SEMI-STD	SH137012	3/8-24 X 1 1/4	100
SH131005	5/16-24 X 1/2	100	*****	3/8-24 X 1 3/8	SEMI-STD
SH131006	5/16-24 X 5/8	100	SH137015	3/8-24 X 1 1/2	100
SH131007	5/16-24 X 3/4	100	*****	3/8-24 X 1 5/8	SEMI-STD
SH131008	5/16-24 X 7/8	100	SH137017	3/8-24 X 1 3/4	100
SH131010	5/16-24 X 1	100	SH137020	3/8-24 X 2	100
SH131012	5/16-24 X 1 1/4	100	SH137022	3/8-24 X 2 1/4	100
SH131015	5/16-24 X 1 1/2	100	SH137025	3/8-24 X 2 1/2	100
SH131017	5/16-24 X 1 3/4	100	*****	3/8-24 X 2 3/4	SEMI-STD
SH131020	5/16-24 X 2	100	SH137030	3/8-24 X 3	100
SH131022	5/16-24 X 2 1/4	100	*****	3/8-24 X 3 1/2	SEMI-STD
SH131025	5/16-24 X 2 1/2	100	*****	3/8-24 X 3 3/4	SEMI-STD
*****	5/16-24 X 2 3/4	SEMI-STD	SH137040	3/8-24 X 4	SEMI-STD
*****	5/16-24 X 3	SEMI-STD	*****	3/8-24 X 4 1/2	SEMI-STD
SH131032	5/16-24 X 3 1/4	SEMI-STD	*****	3/8-24 X 5	SEMI-STD
*****	5/16-24 X 3 1/2	SEMI-STD	*****	3/8-24 X 5 1/2	SEMI-STD
*****	5/16-24 X 4	SEMI-STD	*****	3/8-24 X 6	SEMI-STD
*****	5/16-24 X 4 1/2	SEMI-STD	*****	7/16-20 X 1/2	SEMI-STD

SEMI-STD DIFFÉRENTES QUANTITÉS DISPONIBLES/SEMI-STD PACKAGING ANY QUANTITY



Tel.: (819) 346-2903 / (888) 345-2903 Fax.: (819) 346-3389  
Email: distributeur@boulonstrie.com

VIS À TÊTE CYLINDRIQUE  
À 6 PANS CREUX  
FILETS FINS

NOIR / BARE  
ALLOY STEEL

SOCKET HEAD  
CAP SCREWS  
NATIONAL FINE

LA FINITION PLAQUÉE ZINC  
EST DISPONIBLE  
SUR DEMANDE

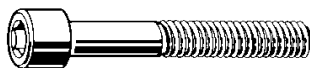

ZINC PLATED IS  
AVAILABLE ON REQUEST

NOTRE CODE	DESCRIPTION	QTÉ/BTE	NOTRE CODE	DESCRIPTION	QTÉ/BTE
OUR CODE	DESCRIPTION	QTY/BOX	OUR CODE	DESCRIPTION	QTY/BOX
***** SH143007	7/16-20 X 5/8 7/16-20 X 3/4	SEMI-STD SEMI-STD	SH150025 *****	1/2-20 X 2 1/2 1/2-20 X 2 3/4	50 SEMI-STD
***** SH143010	7/16-20 X 7/8 7/16-20 X 1	SEMI-STD 100	SH150030 *****	1/2-20 X 3 1/2-20 X 3 1/4	50 SEMI-STD
SH143012	7/16-20 X 1 1/4	100	SH150035	1/2-20 X 3 1/2	SEMI-STD
SH143015	7/16-20 X 1 1/2	100	*****	1/2-20 X 3 3/4	SEMI-STD
***** SH143020	7/16-20 X 1 3/4 7/16-20 X 2	SEMI-STD 100	SH150040 *****	1/2-20 X 4 1/2-20 X 4 1/2	SEMI-STD SEMI-STD
SH143022	7/16-20 X 2 1/4	SEMI-STD	*****	1/2-20 X 5	SEMI-STD
***** SH143030	7/16-20 X 2 1/2 7/16-20 X 3	SEMI-STD SEMI-STD	*****	1/2-20 X 5 1/2 1/2-20 X 6	SEMI-STD SEMI-STD
***** *****	7/16-20 X 3 1/2 7/16-20 X 4	SEMI-STD SEMI-STD	*****	1/2-20 X 7 1/2-20 X 8	SEMI-STD SEMI-STD
***** *****	7/16-20 X 5 7/16-20 X 6	SEMI-STD SEMI-STD	***** SH156012	9/16-18 X 1 9/16-18 X 1 1/4	SEMI-STD SEMI-STD
SH150005	1/2-20 X 1/2	SEMI-STD	SH156015	9/16-18 X 1 1/2	SEMI-STD
SH150006	1/2-20 X 5/8	SEMI-STD	SH156017	9/16-18 X 1 3/4	SEMI-STD
SH150007	1/2-20 X 3/4	SEMI-STD	*****	9/16-18 X 2	SEMI-STD
*****	1/2-20 X 7/8	SEMI-STD	*****	9/16-18 X 2 1/4	SEMI-STD
SH150010	1/2-20 X 1	SEMI-STD	*****	9/16-18 X 2 1/2	SEMI-STD
*****	1/2-20 X 1 1/8	50	*****	9/16-18 X 3	SEMI-STD
SH150012	1/2-20 X 1 1/4	50	*****	9/16-18 X 4	SEMI-STD
*****	1/2-20 X 1 3/8	SEMI-STD	*****	9/16-18 X 4 1/2	SEMI-STD
SH150015	1/2-20 X 1 1/2	50	*****	9/16-18 X 5	SEMI-STD
*****	1/2-20 X 1 3/8	SEMI-STD	*****	9/16-18 X 5 1/2	SEMI-STD
SH150017	1/2-20 X 1 3/4	50	*****	9/16-18 X 6	SEMI-STD
SH150020	1/2-20 X 2	50	SH162010	5/8-18 X 1	50
SH150022	1/2-20 X 2 1/4	50	SH162012	5/8-18 X 1 1/4	50

SEMI-STD DIFFÉRENTES QUANTITÉS DISPONIBLES/SEMI-STD PACKAGING ANY QUANTITY



Tel.: (819) 346-2903 / (888) 345-2903 Fax.: (819) 346-3389  
Email: distributeur@boulonstrie.com

VIS À TÊTE CYLINDRIQUE  
 À 6 PANS CREUX  
 FILETS FINS

NOIR / BARE  
 ALLOY STEEL

SOCKET HEAD  
 CAP SCREWS  
 NATIONAL FINE

LA FINITION PLAQUÉE ZINC  
 EST DISPONIBLE  
 SUR DEMANDE

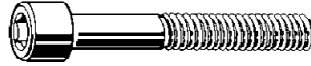

ZINC PLATED IS  
 AVAILABLE ON REQUEST

NOTRE CODE	DESCRIPTION	QTÉ/BTE	NOTRE CODE	DESCRIPTION	QTÉ/BTE
OUR CODE	DESCRIPTION	QTY/BOX	OUR CODE	DESCRIPTION	QTY/BOX
SH162015	5/8-18 X 1 1/2	50	*****	3/4-16 X 4 1/2	SEMI-STD
SH162017	5/8-18 X 1 3/4	50	*****	3/4-16 X 5	SEMI-STD
SH162020	5/8-18 X 2	25	*****	3/4-16 X 5 1/2	SEMI-STD
SH162022	5/8-18 X 2 1/4	SEMI-STD	*****	3/4-16 X 6	SEMI-STD
SH162025	5/8-18 X 2 1/2	25	*****	3/4-16 X 6 1/2	SEMI-STD
*****	5/8-18 X 2 3/4	SEMI-STD	*****	3/4-16 X 7	SEMI-STD
SH162030	5/8-18 X 3	SEMI-STD	*****	3/4-16 X 8	SEMI-STD
*****	5/8-18 X 3 1/4	SEMI-STD	SH187020	7/8-14 X 2	SEMI-STD
*****	5/8-18 X 3 1/2	SEMI-STD	*****	7/8-14 X 2 1/4	SEMI-STD
SH162040	5/8-18 X 4	SEMI-STD	SH187025	7/8-14 X 2 1/2	SEMI-STD
*****	5/8-18 X 4 1/2	SEMI-STD	SH187030	7/8-14 X 3	SEMI-STD
*****	5/8-18 X 5	SEMI-STD	*****	7/8-14 X 3 1/4	SEMI-STD
*****	5/8-18 X 5 1/2	SEMI-STD	*****	7/8-14 X 3 1/2	SEMI-STD
*****	5/8-18 X 6	SEMI-STD	SH187040	7/8-14 X 4	SEMI-STD
*****	5/8-18 X 6 1/2	SEMI-STD	*****	7/8-14 X 4 1/2	SEMI-STD
*****	5/8-18 X 7	SEMI-STD	*****	7/8-14 X 5	SEMI-STD
*****	5/8-18 X 8	SEMI-STD	*****	7/8-14 X 6	SEMI-STD
*****	3/4-16 X 1 1/4	SEMI-STD	*****	7/8-14 X 7	SEMI-STD
*****	3/4-16 X 1 1/2	SEMI-STD	*****	7/8-14 X 8	SEMI-STD
*****	3/4-16 X 1 3/4	SEMI-STD	*****	1-12 X 2	SEMI-STD
SH175020	3/4-16 X 2	SEMI-STD	*****	1-12 X 2 1/4	SEMI-STD
SH175022	3/4-16 X 2 1/4	SEMI-STD	*****	1-12 X 2 1/2	SEMI-STD
SH175025	3/4-16 X 2 1/2	SEMI-STD	*****	1-12 X 3	SEMI-STD
SH175027	3/4-16 X 2 3/4	SEMI-STD	*****	1-12 X 3 1/2	SEMI-STD
SH175030	3/4-16 X 3	SEMI-STD	*****	1-12 X 4	SEMI-STD
*****	3/4-16 X 3 1/4	SEMI-STD	*****	1-12 X 4 1/2	SEMI-STD
*****	3/4-16 X 3 1/2	SEMI-STD	*****	1-12 X 5	SEMI-STD
*****	3/4-16 X 4	SEMI-STD	*****	1-12 X 6	SEMI-STD

SEMI-STD DIFFÉRENTES QUANTITÉS DISPONIBLES/SEMI-STD PACKAGING ANY QUANTITY



Tel.: (819) 346-2903 / (888) 345-2903 Fax.: (819) 346-3389  
 Email: distributeur@boulonsestrie.com

VIS À TÊTE CYLINDRIQUE  
À 6 PANS CREUX  
FILETS FINS

NOIR / BARE  
ALLOY STEEL

SOCKET HEAD  
CAP SCREWS  
NATIONAL FINE

LA FINITION PLAQUÉE ZINC  
EST DISPONIBLE  
SUR DEMANDE

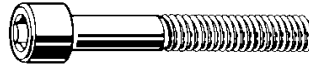

ZINC PLATED IS  
AVAILABLE ON REQUEST

NOTRE CODE	DESCRIPTION	QTÉ/BTE	NOTRE CODE	DESCRIPTION	QTÉ/BTE
OUR CODE	DESCRIPTION	QTY/BOX	OUR CODE	DESCRIPTION	QTY/BOX
*****	1-12 X 7	SEMI-STD	*****	1 1/4-12 X 7	SEMI-STD
*****	1-14 X 2	SEMI-STD	*****	1 1/4-12 X 8	SEMI-STD
*****	1-14 X 2 1/4	SEMI-STD	*****	1 1/4-12 X 9	SEMI-STD
*****	1-14 X 2 1/2	SEMI-STD	*****	1 1/4-12 X 10	SEMI-STD
*****	1-14 X 2 3/4	SEMI-STD	*****	1 1/4-12 X 12	SEMI-STD
SH190030	1-14 X 3	SEMI-STD	*****	1 3/8-12 X 3	SEMI-STD
*****	1-14 X 3 1/4	SEMI-STD	*****	1 3/8-12 X 3 1/2	SEMI-STD
*****	1-14 X 3 1/2	SEMI-STD	*****	1 3/8-12 X 4	SEMI-STD
*****	1-14 X 4	SEMI-STD	*****	1 3/8-12 X 4 1/2	SEMI-STD
*****	1-14 X 4 1/2	SEMI-STD	*****	1 3/8-12 X 5	SEMI-STD
*****	1-14 X 5	SEMI-STD	*****	1 3/8-12 X 5 1/2	SEMI-STD
*****	1-14 X 5 1/2	SEMI-STD	*****	1 3/8-12 X 6	SEMI-STD
*****	1-14 X 6	SEMI-STD	*****	1 3/8-12 X 7	SEMI-STD
*****	1-14 X 7	SEMI-STD	*****	1 3/8-12 X 8	SEMI-STD
*****	1-14 X 8	SEMI-STD	*****	1 3/8-12 X 10	SEMI-STD
*****	1 1/4-12 X 2	SEMI-STD	*****	1 1/2-12 X 3	SEMI-STD
SH192025	1 1/4-12 X 2 1/2	SEMI-STD	*****	1 1/2-12 X 4	SEMI-STD
*****	1 1/4-12 X 3	SEMI-STD	*****	1 1/2-12 X 4 1/2	SEMI-STD
*****	1 1/4-12 X 3 1/2	SEMI-STD	*****	1 1/2-12 X 5	SEMI-STD
SH192040	1 1/4-12 X 4	SEMI-STD	SH195055	1 1/2-12 X 5 1/2	SEMI-STD
SH192045	1 1/4-12 X 4 1/2	SEMI-STD	*****	1 1/2-12 X 6	SEMI-STD
*****	1 1/4-12 X 5	SEMI-STD	*****	1 1/2-12 X 7	SEMI-STD
*****	1 1/4-12 X 5 1/2	SEMI-STD	*****	1 1/2-12 X 8	SEMI-STD
*****	1 1/4-12 X 6	SEMI-STD	*****	1 1/2-12 X 10	SEMI-STD
*****			*****	1 1/2-12 X 12	SEMI-STD

SEMI-STD DIFFÉRENTES QUANTITÉS DISPONIBLES/SEMI-STD PACKAGING ANY QUANTITY



Tel.: (819) 346-2903 / (888) 345-2903 Fax.: (819) 346-3389  
Email: distributeur@boulonstrie.com

VIS À TÊTE  
CYLINDRIQUE  
À 6 PANS CREUX  
GROS FILETS

SS-304  
18-8

SOCKET HEAD  
CAP SCREWS  
NATIONAL COARSE

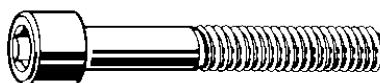

NOTRE CODE	DESCRIPTION	QTÉ/BTE	NOTRE CODE	DESCRIPTION	QTÉ/BTE
OUR CODE	DESCRIPTION	QTY/BOX	OUR CODE	DESCRIPTION	QTY/BOX
SH602005	2-56 X 1/2	100	SH608017	8-32 X 1 3/4	100
SH604002	4-40 X 1/4	100	SH610002	10-24 X 1/4	100
SH604004	4-40 X 3/8	100	SH610004	10-24 X 3/8	100
SH604005	4-40 X 1/2	100	SH610005	10-24 X 1/2	100
SH604007	4-40 X 3/4	100	SH610006	10-24 X 5/8	100
SH604010	4-40 X 1	100	SH610007	10-24 X 3/4	100
SH605002	5-40 X 1/4	100	SH610010	10-24 X 1	100
SH605005	5-40 X 1/2	100	SH610012	10-24 X 1 1/4	100
SH605007	5-40 X 3/4	100	SH610015	10-24 X 1 1/2	100
SH605020	5-40 X 2	100	SH610017	10-24 X 1 3/4	100
SH606001	6-32 X 1/8	100	SH610020	10-24 X 2	100
SH606002	6-32 X 3/16	100	SH611002	10-32 X 1/4	100
SH606003	6-32 X 1/4	100	SH611003	10-32 X 5/16	100
SH606005	6-32 X 1/2	100	SH611004	10-32 X 3/8	100
SH606007	6-32 X 3/4	100	SH611005	10-32 X 1/2	100
SH606008	6-32 X 7/8	100	SH611006	10-32 X 5/8	100
SH606015	6-32 X 1 1/2	100	SH611007	10-32 X 3/4	100
SH606020	6-32 X 2	100	SH611010	10-32 X 1	100
SH608002	8-32 X 1/4	100	SH611012	10-32 X 1 1/4	100
SH608004	8-32 X 3/8	100	SH611015	10-32 X 1 1/2	100
SH608005	8-32 X 1/2	100	SH611017	10-32 X 1 3/4	100
SH608006	8-32 X 5/8	100	SH611020	10-32 X 2	100
SH608007	8-32 X 3/4	100	SH625002	1/4-20 X 1/4	100
SH608008	8-32 X 7/8	100	SH625004	1/4-20 X 3/8	100
SH608010	8-32 X 1	100	SH625005	1/4-20 X 1/2	100
SH608015	8-32 X 1 1/2	100	SH625006	1/4-20 X 5/8	100

AUTRES DIMENSIONS DISPONIBLES/OTHER DIMENSIONS ARE AVAILABLE



Tel.: (819) 346-2903 / (888) 345-2903 Fax.: (819) 346-3389  
Email: distributeur@boulonstrie.com

B-17

VIS À TÊTE  
CYLINDRIQUE  
À 6 PANS CREUX  
GROS FILETS

SS-304  
18-8

SOCKET HEAD  
CAP SCREWS  
NATIONAL COARSE

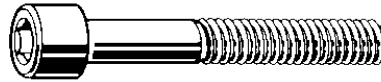

NOTRE CODE	DESCRIPTION	QTÉ/BTE	NOTRE CODE	DESCRIPTION	QTÉ/BTE
OUR CODE	DESCRIPTION	QTY/BOX	OUR CODE	DESCRIPTION	QTY/BOX
SH625007	1/4-20 X 3/4	100	SH637017	3/8-16 X 1 3/4	100
SH625010	1/4-20 X 1	100	SH637020	3/8-16 X 2	100
SH625012	1/4-20 X 1 1/4	100	SH637025	3/8-16 X 2 1/2	100
SH625015	1/4-20 X 1 1/2	100	SH637027	3/8-16 X 2 3/4	100
SH625017	1/4-20 X 1 3/4	100	SH637030	3/8-16 X 3	100
SH625020	1/4-20 X 2	100	SH637035	3/8-16 X 3 1/2	100
SH625022	1/4-20 X 2 1/4	100	SH637040	3/8-16 X 4	100
SH625025	1/4-20 X 2 1/2	100	SH650007	1/2-13 X 3/4	50
SH631005	5/16-18 X 1/2	100	SH650010	1/2-13 X 1	50
SH631006	5/16-18 X 5/8	100	SH650012	1/2-13 X 1 1/4	50
SH631007	5/16-18 X 3/4	100	SH650015	1/2-13 X 1 1/2	50
SH631008	5/16-18 X 7/8	100	SH650017	1/2-13 X 1 3/4	50
SH631010	5/16-18 X 1	100	SH650020	1/2-13 X 2	50
SH631012	5/16-18 X 1 1/4	100	SH650025	1/2-13 X 2 1/2	50
SH631015	5/16-18 X 1 1/2	100	SH650030	1/2-13 X 3	50
SH631017	5/16-18 X 1 3/4	100	SH650035	1/2-13 X 3 1/2	50
SH631020	5/16-18 X 2	100	SH650045	1/2-13 X 4 1/2	50
SH631022	5/16-18 X 2 1/4	100	SH662010	5/8-11 X 1	25
SH631030	5/16-18 X 3	100	SH662012	5/8-11 X 1 1/4	25
SH631040	5/16-18 X 4	100	SH662015	5/8-11 X 1 1/2	25
SH637005	3/8-16 X 1/2	100	SH662020	5/8-11 X 2	25
SH637006	3/8-16 X 5/8	100	SH662025	5/8-11 X 2 1/2	25
SH637007	3/8-16 X 3/4	100	SH662030	5/8-11 X 3	25
SH637010	3/8-16 X 1	100	SH662050	5/8-11 X 5	25
SH637012	3/8-16 X 1 1/4	100	SH662055	5/8-11 X 5 1/2	25
SH637015	3/8-16 X 1 1/2	100	SH662060	5/8-11 X 6	25

AUTRES DIMENSIONS DISPONIBLES/OTHER DIMENSIONS ARE AVAILABLE



Tel.: (819) 346-2903 / (888) 345-2903 Fax.: (819) 346-3389  
Email: distributeur@boulonstrie.com

B-18



VIS À TÊTE  
CYLINDRIQUE  
À 6 PANS CREUX  
GROS FILETS

SS-304  
18-8

SOCKET HEAD  
CAP SCREWS  
NATIONAL COARSE

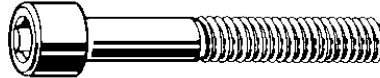

NOTRE CODE	DESCRIPTION	QTÉ/BTE	NOTRE CODE	DESCRIPTION	QTÉ/BTE
OUR CODE	DESCRIPTION	QTY/BOX	OUR CODE	DESCRIPTION	QTY/BOX
SH662067	5/8-11 X 6 3/4	25	SH687025	7/8-9 X 2 1/2	20
SH662070	5/8-11 X 7	25	SH687027	7/8-9 X 2 3/4	20
SH675010	3/4-10 X 1	25	SH687080	7/8-9 X 8	20
SH675015	3/4-10 X 1 1/2	25	SH690025	1-8 X 2 1/2	20
SH675020	3/4-10 X 2	25	SH690030	1-8 X 3	20
SH675025	3/4-10 X 2 1/2	25	SH690035	1-8 X 3 1/2	20
SH675030	3/4-10 X 3	25	SH690045	1-8 X 4 1/2	20

AUTRES DIMENSIONS DISPONIBLES/OTHER DIMENSIONS ARE AVAILABLE



Tel.: (819) 346-2903 / (888) 345-2903 Fax.: (819) 346-3389  
Email: distributeur@boulonsestrie.com

B-19

VIS À TÊTE  
CYLINDRIQUE  
À 6 PANS CREUX  
GROS FILETS

SS-316

SOCKET HEAD  
CAP SCREWS  
NATIONAL COARSE

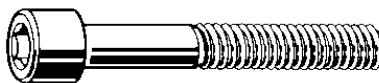

NOTRE CODE	DESCRIPTION	QTÉ/BTE	NOTRE CODE	DESCRIPTION	QTÉ/BTE
OUR CODE	DESCRIPTION	QTY/BOX	OUR CODE	DESCRIPTION	QTY/BOX
SH710005	10-24 X 1/2	100	SH750007	1/2-13 X 3/4	100
SH710006	10-24 X 5/8	100	SH750010	1/2-13 X 1	50
SH710007	10-24 X 3/4	100	SH750012	1/2-13 X 1 1/4	50
SH710010	10-24 X 1	100	SH750015	1/2-13 X 1 1/2	50
SH725005	1/4-20 X 1/2	100	SH750020	1/2-13 X 2	50
SH725007	1/4-20 X 3/4	100	SH750025	1/2-13 X 2 1/2	50
SH725010	1/4-20 X 1	100	SH750035	1/2-13 X 3 1/2	50
SH731007	5/16-18 X 3/4	100	SH750040	1/2-13 X 4	50
SH731010	5/16-18 X 1	100	SH762010	5/8-11 X 1	25
SH731012	5/16-18 X 1 1/4	100	SH762012	5/8-11 X 1 1/4	25
SH737005	3/8-16 X 1/2	100	SH762015	5/8-11 X 1 1/2	25
SH737007	3/8-16 X 3/4	100	SH762017	5/8-11 X 1 3/4	25
SH737010	3/8-16 X 1	100	SH762020	5/8-11 X 2	25
SH737012	3/8-16 X 1 1/4	100	SH775012	3/4-10 X 1 1/4	20
SH737015	3/8-16 X 1 1/2	100	SH775015	3/4-10 X 1 1/2	20
SH737017	3/8-16 X 1 3/4	100	SH775017	3/4-10 X 1 3/4	20
SH737020	3/8-16 X 2	100	*****	3/4-10 X 2	20
SH737022	3/8-16 X 2 1/4	100	SH775022	3/4-10 X 2 1/4	20

AUTRES DIMENSIONS DISPONIBLES / OTHER DIMENSIONS AVAILABLE

AUSSI DISPONIBLE / ALSO AVAILABLE

FILETS FINS / NATIONAL FINE THREADS



Tel.: (819) 346-2903 / (888) 345-2903 Fax.: (819) 346-3389

Email: distributeur@boulonstrie.com

B-20

VIS À TÊTE  
CYLINDRIQUE  
À 6 PANS CREUX  
GROS FILETS

GRADE 12.9  
MÉTRIQUE / METRIC DIN 912

SOCKET HEAD  
CAP SCREWS  
NATIONAL COARSE

NOIR / BARE

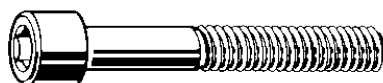

NOTRE CODE	DESCRIPTION	QTÉ/BTE	NOTRE CODE	DESCRIPTION	QTÉ/BTE
OUR CODE	DESCRIPTION	QTY/BOX	OUR CODE	DESCRIPTION	QTY/BOX
*****	M1.6 X .35 X 3	100	SH303020	M3 X .50 X 20	100
*****	M1.6 X .35 X 4	100	SH303025	M3 X .50 X 25	100
*****	M1.6 X .35 X 5	100	SH303030	M3 X .50 X 30	100
*****	M1.6 X .35 X 6	100	SH303035	M3 X .50 X 35	100
*****	M2 X .40 X 3	100	SH303040	M3 X .50 X 40	100
*****	M2 X .40 X 4	100	*****	M3 X .50 X 45	100
*****	M2 X .40 X 5	100	SH303050	M3 X .50 X 50	100
SH302006	M2 X .40 X 6	100	*****	M4 X .70 X 5	100
*****	M2 X .40 X 8	100	SH304006	M4 X .70 X 6	100
SH302010	M2 X .40 X 10	100	SH304008	M4 X .70 X 8	100
SH302012	M2 X .40 X 12	100	SH304010	M4 X .70 X 10	100
*****	M2 X .40 X 16	100	SH304012	M4 X .70 X 12	100
*****	M2.5 X .45 X 4	100	SH304014	M4 X .70 X 14	100
SH302505	M2.5 X .45 X 5	100	SH304016	M4 X .70 X 16	100
SH302506	M2.5X .45 X 6	100	SH304018	M4 X .70 X 18	100
SH302508	M2.5X .45 X 8	100	SH304020	M4 X .70 X 20	100
*****	M2.5X .45 X 10	100	SH304025	M4 X .70 X 25	100
SH302512	M2.5X .45 X 12	100	SH304030	M4 X .70 X 30	100
SH302516	M2.5X .45 X 16	100	SH304035	M4 X .70 X 35	100
SH303005	M3 X .50 X 5	100	SH304040	M4 X .70 X 40	100
SH303006	M3 X .50 X 6	100	SH304045	M4 X .70 X 45	100
SH303008	M3 X .50 X 8	100	SH304050	M4 X .70 X 50	100
SH303010	M3 X .50 X 10	100	SH304055	M4 X .70 X 55	100
SH303012	M3 X .50 X 12	100	SH304060	M4 X .70 X 60	100
*****	M3 X .50 X 14	100	SH304070	M4 X .70 X 70	100
SH303016	M3 X .50 X 16	100	SH305006	M5 X .80 X 6	100

AUTRES DIMENSIONS DISPONIBLES /OTHER DIMENSIONS AVAILABLE



Tel.: (819) 346-2903 / (888) 345-2903 Fax.: (819) 346-3389

Email: distributeur@boulonstrie.com

B-21

VIS À TÊTE  
CYLINDRIQUE  
À 6 PANS CREUX  
GROS FILETS

GRADE 12.9  
MÉTRIQUE / METRIC DIN 912

SOCKET HEAD  
CAP SCREWS  
NATIONAL COARSE

NOIR / BARE

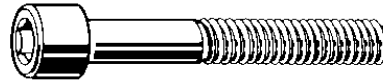

NOTRE CODE	DESCRIPTION	QTÉ/BTE	NOTRE CODE	DESCRIPTION	QTÉ/BTE
OUR CODE	DESCRIPTION	QTY/BOX	OUR CODE	DESCRIPTION	QTY/BOX
SH305008	M5 X .80 X 8	100	*****	M6 X 1.00 X 15	100
SH305010	M5 X .80 X 10	100	SH306016	M6 X 1.00 X 16	100
SH305012	M5 X .80 X 12	100	SH306018	M6 X 1.00 X 18	100
*****	M5 X .80 X 14	100	SH306020	M6 X 1.00 X 20	100
*****	M5 X .80 X 15	100	*****	M6 X 1.00 X 22	100
SH305016	M5 X .80 X 16	100	SH306025	M6 X 1.00 X 25	100
*****	M5 X .80 X 18	100	SH306030	M6 X 1.00 X 30	100
SH305020	M5 X .80 X 20	100	SH306035	M6 X 1.00 X 35	100
*****	M5 X .80 X 22	100	SH306040	M6 X 1.00 X 40	100
SH305025	M5 X .80 X 25	100	SH306045	M6 X 1.00 X 45	100
SH305030	M5 X .80 X 30	100	SH306050	M6 X 1.00 X 50	100
SH305035	M5 X .80 X 35	100	SH306055	M6 X 1.00 X 55	100
SH305040	M5 X .80 X 40	100	SH306060	M6 X 1.00 X 60	100
SH305045	M5 X .80 X 45	100	SH306065	M6 X 1.00 X 65	100
SH305050	M5 X .80 X 50	100	SH306070	M6 X 1.00 X 70	100
SH305055	M5 X .80 X 55	100	SH306075	M6 X 1.00 X 75	100
SH305060	M5 X .80 X 60	100	SH306080	M6 X 1.00 X 80	100
SH305065	M5 X .80 X 65	100	SH306090	M6 X 1.00 X 90	100
SH305070	M5 X .80 X 70	100	SH306100	M6 X 1.00 X 100	100
SH305075	M5 X .80 X 75	100	*****	M6 X 1.00 X 110	100
SH305080	M5 X .80 X 80	100	SH306120	M6 X 1.00 X 120	100
SH305115	M5 X .80 X 115	100	SH308010	M8 X 1.25 X 10	100
SH306008	M6 X 1.00 X 8	100	SH308012	M8 X 1.25 X 12	100
SH306010	M6 X 1.00 X 10	100	*****	M8 X 1.25 X 14	100
SH306012	M6 X 1.00 X 12	100	SH308016	M8 X 1.25 X 16	100
*****	M6 X 1.00 X 14	100	SH308018	M8 X 1.25 X 18	100

AUTRES DIMENSIONS DISPONIBLES / OTHER DIMENSIONS AVAILABLE



Tel.: (819) 346-2903 / (888) 345-2903 Fax.: (819) 346-3389

Email: distributeur@boulonstrie.com

B-22

VIS À TÊTE  
CYLINDRIQUE  
À 6 PANS CREUX  
GROS FILETS

GRADE 12.9  
MÉTRIQUE / METRIC DIN 912

SOCKET HEAD  
CAP SCREWS  
NATIONAL COARSE

NOIR / BARE

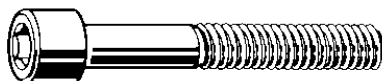

NOTRE CODE	DESCRIPTION	QTÉ/BTE	NOTRE CODE	DESCRIPTION	QTÉ/BTE
OUR CODE	DESCRIPTION	QTY/BOX	OUR CODE	DESCRIPTION	QTY/BOX
SH308020	M8 X 1.25 X 20	100	*****	M10 X 1.25 X 15	100
*****	M8 X 1.25 X 22	100	*****	M10 X 1.25 X 16	100
SH308025	M8 X 1.25 X 25	100	*****	M10 X 1.25 X 18	100
SH308030	M8 X 1.25 X 30	100	*****	M10 X 1.25 X 20	100
SH308035	M8 X 1.25 X 35	100	*****	M10 X 1.25 X 22	100
SH308040	M8 X 1.25 X 40	100	SH310012	M10 X 1.50 X 12	100
SH308045	M8 X 1.25 X 45	100	SH310015	M10 X 1.50 X 15	100
SH308050	M8 X 1.25 X 50	100	SH310016	M10 X 1.50 X 16	100
SH308055	M8 X 1.25 X 55	100	SH310020	M10 X 1.50 X 20	100
SH308060	M8 X 1.25 X 60	100	SH310025	M10 X 1.50 X 25	100
SH308065	M8 X 1.25 X 65	100	SH310030	M10 X 1.50 X 30	100
SH308070	M8 X 1.25 X 70	100	SH310035	M10 X 1.50 X 35	100
SH308075	M8 X 1.25 X 75	100	SH310040	M10 X 1.50 X 40	100
SH308080	M8 X 1.25 X 80	100	SH310045	M10 X 1.50 X 45	50
SH308090	M8 X 1.25 X 90	100	SH310050	M10 X 1.50 X 50	50
SH308100	M8 X 1.25 X 100	100	SH310055	M10 X 1.50 X 55	50
SH308110	M8 X 1.25 X 110	100	SH310060	M10 X 1.50 X 60	50
SH308120	M8 X 1.25 X 120	100	SH310065	M10 X 1.50 X 65	50
SH308130	M8 X 1.25 X 130	100	SH310070	M10 X 1.50 X 70	50
SH308140	M8 X 1.25 X 140	100	SH310075	M10 X 1.50 X 75	50
*****	M8 X 1.25 X 150	100	SH310080	M10 X 1.50 X 80	50
SH308160	M8 X 1.25 X 160	100	SH310090	M10 X 1.50 X 90	50
*****	M8 X 1.25 X 180	100	SH310100	M10 X 1.50 X 100	50
*****	M8 X 1.25 X 200	100	*****	M10 X 1.50 X 110	50
*****	M10 X 1.25 X 12	100	SH310120	M10 X 1.50 X 120	50
*****	M10 X 1.25 X 14	100	*****	M10 X 1.50 X 130	50

AUTRES DIMENSIONS DISPONIBLES / OTHER DIMENSIONS AVAILABLE



Tel.: (819) 346-2903 / (888) 345-2903 Fax.: (819) 346-3389

Email: distributeur@boulonstrie.com

B-23

VIS À TÊTE  
CYLINDRIQUE  
À 6 PANS CREUX  
GROS FILETS

GRADE 12.9  
MÉTRIQUE / METRIC DIN 912

SOCKET HEAD  
CAP SCREWS  
NATIONAL COARSE

NOIR / BARE

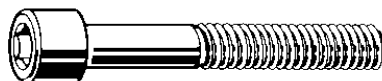

NOTRE CODE	DESCRIPTION	QTÉ/BTE	NOTRE CODE	DESCRIPTION	QTÉ/BTE
OUR CODE	DESCRIPTION	QTY/BOX	OUR CODE	DESCRIPTION	QTY/BOX
*****	M10 X 1.50 X 140	50	SH312140	M12 X 1.75 X 140	25
SH310150	M10 X 1.50 X 150	50	*****	M12 X 1.75X 150	25
SH310160	M10 X 1.50 X 160	25	SH312160	M12 X 1.75 X 160	10
SH310180	M10 X 1.50 X 180	25	*****	M12X 1.75 X 180	10
*****	M10 X 1.50 X 200	25	SH312200	M12 X 1.75 X 200	10
*****	M12 X 1.75X 12	50	SH314030	M14 X 2.00 X 30	50
SH312016	M12 X 1.75 X 16	50	SH314035	M14 X 2.00 X 35	50
*****	M12X 1.75 X 18	50	SH314040	M14 X 2.00 X 40	50
SH312020	M12 X 1.75 X 20	50	*****	M14 X 2.00 X 45	50
SH312025	M12 X 1.75 X 25	50	SH314050	M14 X 2.00 X 50	50
SH312030	M12 X 1.75 X 30	50	SH314055	M14 X 2.00 X 55	50
SH312035	M12 X 1.75 X 35	50	SH314060	M14 X 2.00 X 60	25
SH312040	M12 X 1.75 X 40	50	SH314070	M14 X 2.00 X 70	25
SH312045	M12 X 1.75 X 45	50	SH314080	M14 X 2.00 X 80	25
SH312050	M12 X 1.75 X 50	50	*****	M14 X 2.00 X 90	25
SH312055	M12 X 1.75 X 55	50	*****	M14X 2.00 X 100	25
SH312060	M12 X 1.75 X 60	50	*****	M14X 2.00 X 110	25
SH312065	M12 X 1.75 X 65	50	SH314120	M14 X 2.00 X 120	25
SH312070	M12 X 1.75 X 70	25	*****	M14 X 2.00 X 130	25
SH312075	M12 X 1.75 X 75	25	SH316020	M16 X 2.00 X 20	25
SH312080	M12 X 1.75 X 80	25	SH316025	M16 X 2.00 X 25	25
SH312090	M12 X 1.75 X 90	25	SH316030	M16 X 2.00 X 30	25
SH312100	M12 X 1.75 X 100	25	SH316035	M16 X 2.00 X 35	25
SH312110	M12 X 1.75 X 110	25	SH316040	M16 X 2.00 X40	25
SH312120	M12 X 1.75 X 120	25	SH316045	M16 X 2.00 X 45	25
*****	M12X 1.75 X 130	25	SH316050	M16 X 2.00 X 50	25

AUTRES DIMENSIONS DISPONIBLES /OTHER DIMENSIONS AVAILABLE



Tel.: (819) 346-2903 / (888) 345-2903 Fax.: (819) 346-3389

Email: distributeur@boulonstrie.com

B-24

VIS À TÊTE  
CYLINDRIQUE  
À 6 PANS CREUX  
GROS FILETS

GRADE 12.9  
MÉTRIQUE / METRIC DIN 912

SOCKET HEAD  
CAP SCREWS  
NATIONAL COARSE

NOIR / BARE

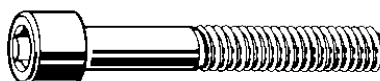

NOTRE CODE	DESCRIPTION	QTÉ/BTE	NOTRE CODE	DESCRIPTION	QTÉ/BTE
OUR CODE	DESCRIPTION	QTY/BOX	OUR CODE	DESCRIPTION	QTY/BOX
SH316055	M16 X 2.00 X 55	25	*****	M18 X 2.50 X 75	25
SH316060	M16 X 2.00 X 60	25	SH318080	M18 X 2.50 X 80	25
SH316065	M16 X 2.00 X 65	25	*****	M18 X 2.50 X 90	25
SH316070	M16 X 2.00 X 70	25	SH318100	M18 X 2.50 X 100	10
SH316075	M16 X 2.00 X 75	25	*****	M18 X 2.50 X 110	10
SH316080	M16 X 2.00 X 80	25	*****	M18 X 2.50 X 120	10
SH316090	M16 X 2.00 X 90	25	*****	M18 X 2.50 X 130	10
SH316100	M16 X 2.00 X 100	25	*****	M18 X 2.50 X 140	10
SH316110	M16 X 2.00 X 110	25	*****	M18 X 2.50 X 150	10
SH316120	M16 X 2.00 X 120	25	*****	M18 X 2.50 X 160	10
SH316130	M16 X 2.00 X 130	25	*****	M18 X 2.50 X 180	10
SH316140	M16 X 2.00 X 140	10	*****	M18 X 2.50 X 200	10
SH316150	M16 X 2.00 X 150	10	*****	M20 X 2.50 X 35	25
SH316160	M16 X 2.00 X 160	10	SH320040	M20 X 2.50 X 40	25
SH316180	M16 X 2.00 X 180	10	SH320045	M20 X 2.50 X 45	25
SH316200	M16 X 2.00 X 200	10	SH320050	M20 X 2.50 X 50	25
SH316220	M16 X 2.00 X 220	10	SH320055	M20 X 2.50 X 55	25
*****	M18 X 2.50 X 30	25	SH320060	M20 X 2.50 X 60	25
*****	M18 X 2.50 X 35	25	SH320065	M20 X 2.50 X 65	25
*****	M18 X 2.50 X 40	25	SH320070	M20 X 2.50 X 70	25
*****	M18 X 2.50 X 45	25	*****	M20 X 2.50 X 75	25
*****	M18 X 2.50 X 50	25	SH320080	M20 X 2.50 X 80	25
SH318055	M18 X 2.50 X 55	25	SH320090	M20 X 2.50 X 90	25
*****	M18 X 2.50 X 60	25	SH320100	M20 X 2.50 X 100	25
*****	M18 X 2.50 X 65	25	SH320110	M20 X 2.50 X 110	25
*****	M18 X 2.50 X 70	25	SH320120	M20 X 2.50 X 120	25

AUTRES DIMENSIONS DISPONIBLES / OTHER DIMENSIONS AVAILABLE



Tel.: (819) 346-2903 / (888) 345-2903 Fax.: (819) 346-3389

Email: distributeur@boulonstrie.com

B-25

VIS À TÊTE  
CYLINDRIQUE  
À 6 PANS CREUX  
GROS FILETS

GRADE 12.9  
MÉTRIQUE / METRIC DIN 912

SOCKET HEAD  
CAP SCREWS  
NATIONAL COARSE

NOIR / BARE

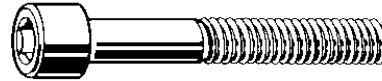

NOTRE CODE	DESCRIPTION	QTÉ/BTE	NOTRE CODE	DESCRIPTION	QTÉ/BTE
OUR CODE	DESCRIPTION	QTY/BOX	OUR CODE	DESCRIPTION	QTY/BOX
SH320130	M20 X 2.50 X 130	10	*****	M22 X 2.50 X 130	10
*****	M20 X 2.50 X 140	10	*****	M22 X 2.50 X 140	10
SH320150	M20 X 2.50 X 150	10	*****	M22 X 2.50 X 150	10
SH320160	M20 X 2.50 X 160	10	*****	M22 X 2.50 X 160	10
SH320180	M20 X 2.50 X 180	10	*****	M22 X 2.50 X 180	10
SH320200	M20 X 2.50 X 200	10	*****	M22 X 2.50 X 200	10
*****	M20 X 2.50 X 220	5	SH324050	M24 X 3.00 X 50	10
*****	M20 X 2.50 X 240	5	SH324055	M24 X 3.00 X 55	10
*****	M20 X 2.50 X 260	5	SH324060	M24 X 3.00 X 60	10
*****	M20 X 2.50 X 280	5	*****	M24 X 3.00 X 65	10
*****	M20 X 2.50 X 300	5	SH324070	M24 X 3.00 X 70	10
*****	M20 X 2.50 X 320	1	*****	M24 X 3.00 X 75	10
*****	M20 X 2.50 X 340	1	*****	M24 X 3.00 X 80	10
*****	M22 X 2.50 X 40	10	*****	M24 X 3.00 X 90	10
*****	M22 X 2.50 X 45	10	*****	M24 X 3.00 X 100	**
*****	M22 X 2.50 X 50	10	*****	M24 X 3.00 X 110	**
*****	M22 X 2.50 X 55	10	SH324120	M24 X 3.00 X 120	10
*****	M22 X 2.50 X 60	10	SH324130	M24 X 3.00 X 130	10
*****	M22 X 2.50 X 65	10	*****	M24 X 3.00 X 140	10
*****	M22 X 2.50 X 70	10	*****	M24 X 3.00 X 150	10
*****	M22 X 2.50 X 75	10	*****	M24 X 3.00 X 160	10
*****	M22 X 2.50 X 80	10	SH324180	M24 X 3.00 X 180	10
*****	M22 X 2.50 X 90	10	*****	M24 X 3.00 X 200	10
*****	M22 X 2.50 X 100	10	*****	M24 X 3.00 X 220	5
*****	M22 X 2.50 X 110	10	*****	M24 X 3.00 X 240	5
*****	M22 X 2.50 X 120	10	*****	M24 X 3.00 X 260	5

AUTRES DIMENSIONS DISPONIBLES / OTHER DIMENSIONS AVAILABLE



Tel.: (819) 346-2903 / (888) 345-2903 Fax.: (819) 346-3389

Email: distributeur@boulonstrie.com

B-26



VIS À TÊTE  
CYLINDRIQUE  
À 6 PANS CREUX  
GROS FILETS

GRADE 12.9  
MÉTRIQUE / METRIC DIN 912

SOCKET HEAD  
CAP SCREWS  
NATIONAL COARSE

NOIR / BARE

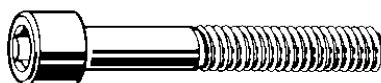

NOTRE CODE	DESCRIPTION	QTÉ/BTE	NOTRE CODE	DESCRIPTION	QTÉ/BTE
OUR CODE	DESCRIPTION	QTY/BOX	OUR CODE	DESCRIPTION	QTY/BOX
*****	M24 X 3.00 X 280	5	*****	M30 X 3.50 X 130	1
*****	M24 X 3.00 X 300	5	*****	M30 X 3.50 X 140	1
*****	M24 X 3.00 X 320	1	*****	M30 X 3.50 X 150	1
*****	M24 X 3.00 X 340	1	*****	M30 X 3.50 X 160	1
*****	M27 X 3.00 X 80	5	*****	M30 X 3.50 X 180	1
*****	M27 X 3.00 X 90	5	*****	M30 X 3.50 X 200	1
*****	M27 X 3.00 X 100	5	*****	M30 X 3.50 X 240	1
*****	M27 X 3.00 X 110	5	*****	M30 X 3.50 X 260	1
*****	M27 X 3.00 X 120	5	*****	M30 X 3.50 X 300	1
*****	M27 X 3.00 X 130	5	*****	M30 X 3.50 X 320	1
*****	M27 X 3.00 X 140	5	*****	M30 X 3.50 X 360	1
*****	M27 X 3.00 X 150	5	*****	M30 X 3.50 X 380	1
*****	M27 X 3.00 X 160	5	*****	M30 X 3.50 X 400	1
*****	M27 X 3.00 X 180	5	*****	M36 X 4.00 X 70	1
*****	M27 X 3.00 X 200	1	*****	M36 X 4.00 X 80	1
*****	M27 X 3.00 X 220	1	*****	M36 X 4.00 X 90	1
*****	M27 X 3.00 X 240	1	*****	M36 X 4.00 X 100	1
*****	M27 X 3.00 X 260	1	*****	M36 X 4.00 X 110	1
*****	M27 X 3.00 X 280	1	*****	M36 X 4.00 X 120	1
*****	M27 X 3.00 X 300	1	*****	M36 X 4.00 X 130	1
*****	M30 X 3.50 X 70	1	*****	M36 X 4.00 X 140	1
*****	M30 X 3.50 X 80	1	*****	M36 X 4.00 X 150	1
*****	M30 X 3.50 X 90	1	*****	M36 X 4.00 X 160	1
*****	M30 X 3.50 X 100	1	*****	M36 X 4.00 X 180	1
*****	M30 X 3.50 X 110	1	*****	M36 X 4.00 X 200	1
*****	M30 X 3.50 X 120	1	*****	M36 X 4.00 X 240	1

AUTRES DIMENSIONS DISPONIBLES /OTHER DIMENSIONS AVAILABLE



Tel.: (819) 346-2903 / (888) 345-2903 Fax.: (819) 346-3389

Email: distributeur@boulonstrie.com

B-27

**VIS À TÊTE  
CYLINDRIQUE  
À 6 PANS CREUX  
GROS FILETS**

**GRADE 12.9  
MÉTRIQUE / METRIC DIN 912**

**SOCKET HEAD  
CAP SCREWS  
NATIONAL COARSE**

**NOIR / BARE**

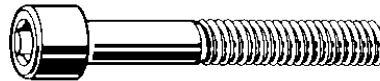

NOTRE CODE	DESCRIPTION	QTÉ/BTE	NOTRE CODE	DESCRIPTION	QTÉ/BTE
OUR CODE	DESCRIPTION	QTY/BOX	OUR CODE	DESCRIPTION	QTY/BOX
*****	M36 X 4.00 X 260	1	*****	M42 X 4.50 X 220	1
*****	M36 X 4.00 X 300	1	*****	M42 X 4.50 X 240	1
*****	M36 X 4.00 X 320	1	*****	M42 X 4.50 X 260	1
*****	M36 X 4.00 X 360	1	*****	M42 X 4.50 X 280	1
*****	M36 X 4.00 X 380	1	*****	M42 X 4.50 X 300	1
*****	M36 X 4.00 X 400	1	*****	M42 X 4.50 X 320	1
*****	M42 X 4.50 X 100	1	*****	M42 X 4.50 X 340	1
*****	M42 X 4.50 X 110	1	*****	M42 X 4.50 X 360	1
*****	M42 X 4.50 X 120	1	*****	M42 X 4.50 X 380	1
*****	M42 X 4.50 X 130	1	*****	M42 X 4.50 X 400	1
*****	M42 X 4.50 X 140	1	<b>AUSSI DISPONIBLE ALSO AVAILABLE MÉTRIQUE ACIER INOXYDABLE METRIC STAINLESS STEEL</b>		
*****	M42 X 4.50 X 150	1			
*****	M42 X 4.50 X 160	1			
*****	M42 X 4.50 X 180	1			
*****	M42 X 4.50 X 200	1			

**AUTRES DIMENSIONS DISPONIBLES /OTHER DIMENSIONS AVAILABLE**



**Tel.: (819) 346-2903 / (888) 345-2903 Fax.: (819) 346-3389  
Email: distributeur@boulonsestrie.com**

**B-28**

**VIS À TÊTE BASSE  
À 6 PANS CREUX  
GROS FILETS**

**NOIR / BARE  
ALLOY STEEL**

**LOW HEAD SOCKET  
CAP SCREWS  
NATIONAL COARSE**

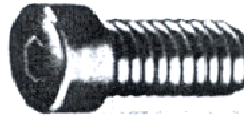

NOTRE CODE	DESCRIPTION	QTÉ/BTE
OUR CODE	DESCRIPTION	QTY/BOX
*****	8-32 X 3/8	100
*****	8-32 X 1/2	100
*****	8-32 X 5/8	100
*****	8-32 X 3/4	100
*****	8-32 X 1	100
*****	10-24 X 3/8	100
*****	10-24 X 1/2	100
*****	10-24 X 5/8	100
*****	10-24 X 3/4	100
*****	10-24 X 1	100
*****	10-32 X 3/8	100
*****	10-32 X 1/2	100
*****	10-32 X 5/8	100
*****	10-32 X 3/4	100
*****	10-32 X 1	100
*****	1/4 -20 X 3/8	100
SL025005	1/4-20 X 1/2	100
SL025006	1/4-20 X 5/8	100
*****	1/4-20 X 3/4	100
SL025010	1/4-20 X 1	100
*****	1/4-20 X 1 1/4	100
*****	5/16-18 X 1/2	100
*****	5/16-18 X 5/8	100
SL031007	5/16-18 X 3/4	100
SL031010	5/16-18 X 1	100
*****	5/16-18 X 1 1/4	100
*****	5/16-18 X 1 1/2	100

**AUTRES DIMENSIONS DISPONIBLES / OTHER DIMENSIONS AVAILABLE**



**Tel.: (819) 346-2903 / (888) 345-2903 Fax.: (819) 346-3389  
Email: distributeur@boulonsestrie.com**

**B-29**

**VIS À TÊTE BASSE  
À 6 PANS CREUX  
GROS FILETS**

**NOIR / BARE  
ALLOY STEEL**

**LOW HEAD SOCKET  
CAP SCREWS  
NATIONAL COARSE**

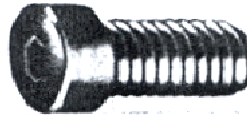

<b>NOTRE CODE</b>	<b>DESCRIPTION</b>	<b>QTÉ/BTE</b>
<b>OUR CODE</b>	<b>DESCRIPTION</b>	<b>QTY/BOX</b>
*****	3/8-16 X 1/2	100
*****	3/8-16 X 5/8	100
SL037007	3/8-16 X 3/4	100
SL037010	3/8-16 X 1	100
SL037012	3/8-16 X 1 1/4	100
*****	3/8-16 X 1 1/2	100
*****	1/2-13 X 3/4	50
SL050010	1/2-13 X 1	50
SL050012	1/2-13 X 1 1/4	50
SL050015	1/2-13 X 1 1/2	50

**AUTRES DIMENSIONS DISPONIBLES / OTHER DIMENSIONS AVAILABLE**



**Tel.: (819) 346-2903 / (888) 345-2903 Fax.: (819) 346-3389  
Email: distributeur@boulonsestrie.com**

VIS À TÊTE BASSE  
À 6 PANS CREUX  
GROS FILETS

MÉTRIQUE DIN 7984 METRIC

LOW HEAD SOCKET  
CAP SCREWS  
NATIONAL COARSE



NOTRE CODE	DESCRIPTION	QTÉ/BTE	NOTRE CODE	DESCRIPTION	QTÉ/BTE
OUR CODE	DESCRIPTION	QTY/BOX	OUR CODE	DESCRIPTION	QTY/BOX
*****	M4 X .70 X 6	100	SL208020	M8 X 1.25 X 20	100
*****	M4 X .70 X 8	100	SL208025	M8 X 1.25 X 25	100
*****	M4 X .70 X 10	100	SL208030	M8 X 1.25 X 30	100
*****	M4 X .70 X 12	100	SL208035	M8 X 1.25 X 35	100
*****	M4 X .70 X 16	100	*****	M10 X 1.50 X 12	100
*****	M4 X .70 X 20	100	*****	M10 X 1.50 X 16	100
*****	M4 X .70 X 25	100	*****	M10 X 1.50 X 20	100
*****	M5 X .80 X 10	100	SL210025	M10 X 1.50 X 25	100
SL205012	M5 X .80 X 12	100	SL210030	M10 X 1.50 X 30	100
SL205016	M5 X .80 X 16	100	SL210035	M10 X 1.50 X 35	100
*****	M5 X .80 X 20	100	*****	M12 X 2.00 X 20	50
*****	M5 X .80 X 25	100	SL212025	M12 X 2.00 X 25	50
SL206010	M6 X 1.00 X 10	100	*****	M12 X 2.00 X 30	50
*****	M6 X 1.00 X 12	100	*****	M12 X 2.00 X 35	50
*****	M6 X 1.00 X 16	100	*****	M12 X 2.00 X 40	50
SL206020	M6 X 1.00 X 20	100	*****	M12 X 2.00 X 50	50
SL206025	M6 X 1.00 X 25	100	*****	M12 X 2.00 X 60	50
*****	M6 X 1.00 X 30	100	*****	M12 X 2.00 X 80	50
*****	M8 X 1.25 X 10	100	SL216040	M16 X 2.00 X 40	50
SL208012	M8 X 1.25 X 12	100	SL216050	M16 X 2.00 X 50	50
SL208016	M8 X 1.25 X 16	100	SL216060	M16 X 2.00 X 60	25

AUTRES DIMENSIONS DISPONIBLES / OTHER DIMENSIONS ARE AVAILABLE



Tel.: (819) 346-2903 / (888) 345-2903 Fax.: (819) 346-3389

Email: distributeur@boulonstrie.com

VIS À TÊTE FRAISÉE  
 À 6 PANS CREUX  
 GROS FILETS

NOIR / BARE  
 ALLOY STEEL

FLAT HEAD SOCKET  
 CAP SCREWS  
 NATIONAL COARSE

LA FINITION PLAQUÉE ZINC  
 EST DISPONIBLE  
 SUR DEMANDE

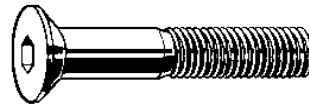

ZINC PLATED IS  
 AVAILABLE ON REQUEST

NOTRE CODE	DESCRIPTION	QTÉ/BTE	NOTRE CODE	DESCRIPTION	QTÉ/BTE
OUR CODE	DESCRIPTION	QTY/BOX	OUR CODE	DESCRIPTION	QTY/BOX
*****	2-56 X 1/8	SEMI-STD	*****	4-40 X 1 1/4	SEMI-STD
*****	2-56 X 3/16	100	SF005002	5-40 X 1/4	100
SF002002	2-56 X 1/4	100	SF005004	5-40 X 3/8	100
*****	2-56 X 5/16	SEMI-STD	SF005005	5-40 X 1/2	100
SF002004	2-56 X 3/8	100	*****	5-40 X 5/8	100
*****	2-56 X 1/2	100	SF005007	5-40 X 3/4	100
*****	2-56 X 5/8	SEMI-STD	*****	5-40 X 1	SEMI-STD
*****	2-56 X 3/4	SEMI-STD	*****	5-40 X 1 1/4	SEMI-STD
*****	2-56 X 7/8	SEMI-STD	*****	5-40 X 1 1/2	SEMI-STD
*****	2-56 X 1	SEMI-STD	SF006001	6-32 X 3/16	SEMI-STD
*****	3-48 X 3/16	100	SF006002	6-32 X 1/4	100
*****	3-48 X 1/4	100	SF006003	6-32 X 5/16	SEMI-STD
*****	3-48 X 5/16	SEMI-STD	SF006004	6-32 X 3/8	100
*****	3-48 X 3/8	100	*****	6-32 X 7/16	SEMI-STD
*****	3-48 X 1/2	100	SF006005	6-32 X 1/2	100
*****	3-48 X 5/8	SEMI-STD	SF006006	6-32 X 5/8	100
*****	3-48 X 3/4	SEMI-STD	SF006007	6-32 X 3/4	100
*****	3-48 X 1	SEMI-STD	*****	6-32 X 7/8	SEMI-STD
SF004000	4-40 X 3/16	SEMI-STD	SF006010	6-32 X 1	SEMI-STD
SF004002	4-40 X 1/4	100	*****	6-32 X 1 1/4	SEMI-STD
SF004003	4-40 X 5/16	SEMI-STD	*****	6-32 X 1 1/2	SEMI-STD
SF004004	4-40 X 3/8	100	*****	6-32 X 1 3/4	SEMI-STD
*****	4-40 X 7/16	SEMI-STD	SF006020	6-32 X 2	SEMI-STD
SF004005	4-40 X 1/2	100	*****	6-32 X 2 1/4	SEMI-STD
*****	4-40 X 5/8	100	*****	6-32 X 2 1/2	SEMI-STD
SF004007	4-40 X 3/4	100	*****	6-32 X 3	SEMI-STD
*****	4-40 X 7/8	SEMI-STD	SF008002	8-32 X 1/4	SEMI-STD
*****	4-40 X 1	SEMI-STD	SF008003	8-32 X 5/16	SEMI-STD

SEMI-STD PLUSIEURS QUANTITÉS DISPONIBLES / SEMI-STD PACKAGING ANY QUANTITY



Tel.: (819) 346-2903 / (888) 345-2903 Fax.: (819) 346-3389  
 Email: distributeur@boulonstrie.com

VIS À TÊTE FRAISÉE  
 À 6 PANS CREUX  
 GROS FILETS

NOIR / BARE  
 ALLOY STEEL

FLAT HEAD SOCKET  
 CAP SCREWS  
 NATIONAL COARSE

LA FINITION PLAQUÉE ZINC  
 EST DISPONIBLE  
 SUR DEMANDE

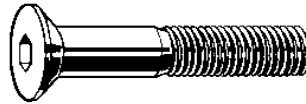

ZINC PLATED IS  
 AVAILABLE ON REQUEST

NOTRE CODE	DESCRIPTION	QTÉ/BTE	NOTRE CODE	DESCRIPTION	QTÉ/BTE
OUR CODE	DESCRIPTION	QTY/BOX	OUR CODE	DESCRIPTION	QTY/BOX
SF008004	8-32 X 3/8	100	*****	10-24 X 3	SEMI-STD
*****	8-32 X 7/16	SEMI-STD	SF012005	12-24 X 1/2	SEMI-STD
SF008005	8-32 X 1/2	100	*****	12-24 X 5/8	SEMI-STD
SF008006	8-32 X 5/8	100	SF012007	12-24 X 3/4	SEMI-STD
SF008007	8-32 X 3/4	100	SF012010	12-24 X 1	SEMI-STD
SF008008	8-32 X 7/8	SEMI-STD	SF025003	1/4-20 X 3/8	100
SF008010	8-32 X 1	100	SF025005	1/4-20 X 1/2	100
SF008012	8-32 X 1 1/4	SEMI-STD	SF025006	1/4-20 X 5/8	100
SF008015	8-32 X 1 1/2	SEMI-STD	SF025007	1/4-20 X 3/4	100
*****	8-32 X 1 3/4	SEMI-STD	*****	1/4-20 X 7/8	SEMI-STD
SF008020	8-32 X 2	SEMI-STD	SF025010	1/4-20 X 1	100
*****	8-32 X 2 1/4	SEMI-STD	*****	1/4-20 X 1 1/8	SEMI-STD
*****	8-32 X 2 1/2	SEMI-STD	SF025012	1/4-20 X 1 1/4	100
SF010002	10-24 X 1/4	SEMI-STD	SF025015	1/4-20 X 1 1/2	100
SF010003	10-24 X 5/16	SEMI-STD	SF025017	1/4-20 X 1 3/4	100
SF010004	10-24 X 3/8	100	SF025020	1/4-20 X 2	100
*****	10-24 X 7/16	SEMI-STD	SF025022	1/4-20 X 2 1/4	SEMI-STD
SF010005	10-24 X 1/2	100	SF025025	1/4-20 X 2 1/2	SEMI-STD
SF010006	10-24 X 5/8	100	*****	1/4-20 X 2 3/4	SEMI-STD
SF010007	10-24 X 3/4	100	SF025030	1/4-20 X 3	SEMI-STD
*****	10-24 X 7/8	SEMI-STD	SF025035	1/4-20 X 3 1/2	SEMI-STD
SF010010	10-24 X 1	100	*****	1/4-20 X 4	SEMI-STD
SF010012	10-24 X 1 1/4	100	*****	5/16-18 X 1/4	100
SF010015	10-24 X 1 1/2	100	SF031004	5/16-18 X 3/8	SEMI-STD
SF010017	10-24 X 1 3/4	SEMI-STD	SF031005	5/16-18 X 1/2	100
SF010020	10-24 X 2	SEMI-STD	SF031006	5/16-18 X 5/8	100
SF010022	10-24 X 2 1/4	SEMI-STD	SF031007	5/16-18 X 3/4	100
SF010025	10-24 X 2 1/2	SEMI-STD	SF031008	5/16-18 X 7/8	SEMI-STD

SEMI-STD PLUSIEURS QUANTITÉS DISPONIBLES / SEMI-STD PACKAGING ANY QUANTITY



Tel.: (819) 346-2903 / (888) 345-2903 Fax.: (819) 346-3389  
 Email: distributeur@boulonsestrie.com

VIS À TÊTE FRAISÉE  
 À 6 PANS CREUX  
 GROS FILETS

NOIR / BARE  
 ALLOY STEEL

FLAT HEAD SOCKET  
 CAP SCREWS  
 NATIONAL COARSE

LA FINITION PLAQUÉE ZINC  
 EST DISPONIBLE  
 SUR DEMANDE

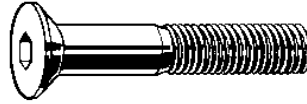

ZINC PLATED IS  
 AVAILABLE ON REQUEST

NOTRE CODE	DESCRIPTION	QTÉ/BTE	NOTRE CODE	DESCRIPTION	QTÉ/BTE
OUR CODE	DESCRIPTION	QTY/BOX	OUR CODE	DESCRIPTION	QTY/BOX
SF031010	5/16-18 X 1	100	*****	3/8-16 X 5	SEMI-STD
SF031012	5/16-18 X 1 1/4	100	*****	3/8-16 X 5 1/2	SEMI-STD
SF031015	5/16-18 X 1 1/2	100	*****	3/8-16 X 6	SEMI-STD
SF031017	5/16-18 X 1 3/4	100	*****	7/16 -14 X 3/4	100
SF031020	5/16-18 X 2	100	*****	7/16-14 X 7/8	SEMI-STD
SF031022	5/16-18 X 2 1/4	100	SF043010	7/16-14 X 1	100
SF031025	5/16-18 X 2 1/2	100	SF043012	7/16-14 X 1 1/4	100
*****	5/16-18 X 2 3/4	SEMI-STD	SF043015	7/16-14 X 1 1/2	100
SF031030	5/16-18 X 3	SEMI-STD	SF043017	7/16-14 X 1 3/4	100
*****	5/16-18 X 3 1/2	SEMI-STD	SF043020	7/16-14 X 2	50
*****	5/16-18 X 4	SEMI-STD	SF043022	7/16-14 X 2 1/4	SEMI-STD
SF037005	3/8-16 X 1/2	100	*****	7/16-14 X 2 1/2	SEMI-STD
SF037006	3/8-16 X 5/8	100	*****	7/16-14 X 3	SEMI-STD
SF037007	3/8-16 X 3/4	100	*****	7/16-14 X 3 1/2	SEMI-STD
*****	3/8-16 X 7/8	SEMI-STD	*****	7/16-14 X 4	SEMI-STD
SF037010	3/8-16 X 1	100	SF050007	1/2-13 X 3/4	100
SF037012	3/8-16 X 1 1/4	100	*****	1/2-13 X 7/8	SEMI-STD
SF037014	3/8-16 X 1 3/8	SEMI-STD	SF050010	1/2-13 X 1	100
SF037015	3/8-16 X 1 1/2	100	SF050012	1/2-13 X 1 1/4	100
SF037017	3/8-16 X 1 3/4	100	SF050015	1/2-13 X 1 1/2	100
SF037020	3/8-16 X 2	100	SF050017	1/2-13 X 1 3/4	50
SF037022	3/8-16 X 2 1/4	100	SF050020	1/2-13 X 2	50
SF037025	3/8-16 X 2 1/2	100	SF050022	1/2-13 X 2 1/4	50
SF037027	3/8-16 X 2 3/4	SEMI-STD	SF050025	1/2-13 X 2 1/2	50
SF037030	3/8-16 X 3	100	SF050027	1/2-13 X 2 3/4	SEMI-STD
SF037035	3/8-16 X 3 1/2	SEMI-STD	SF050030	1/2-13 X 3	50
SF037040	3/8-16 X 4	SEMI-STD	*****	1/2-13 X 3 1/4	SEMI-STD
SF037045	3/8-16 X 4 1/2	SEMI-STD	SF050035	1/2-13 X 3 1/2	SEMI-STD

SEMI-STD PLUSIEURS QUANTITÉS DISPONIBLES / SEMI-STD PACKAGING ANY QUANTITY



Tel.: (819) 346-2903 / (888) 345-2903 Fax.: (819) 346-3389  
 Email: distributeur@boulonsestrie.com



VIS À TÊTE FRAISÉE  
 À 6 PANS CREUX  
 GROS FILETS

NOIR / BARE  
 ALLOY STEEL

FLAT HEAD SOCKET  
 CAP SCREWS  
 NATIONAL COARSE

LA FINITION PLAQUÉE ZINC  
 EST DISPONIBLE  
 SUR DEMANDE

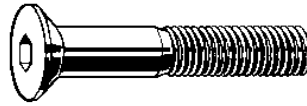

ZINC PLATED IS  
 AVAILABLE ON REQUEST

NOTRE CODE	DESCRIPTION	QTÉ/BTE	NOTRE CODE	DESCRIPTION	QTÉ/BTE
OUR CODE	DESCRIPTION	QTY/BOX	OUR CODE	DESCRIPTION	QTY/BOX
SF050040	1/2-13 X 4	SEMI-STD	*****	3/4-10 X 2 1/4	25
SF050045	1/2-13 X 4 1/2	SEMI-STD	SF075025	3/4-10 X 2 1/2	25
SF050050	1/2-13 X 5	SEMI-STD	*****	3/4-10 X 2 3/4	SEMI-STD
SF050060	1/2-13 X 6	SEMI-STD	SF075030	3/4-10 X 3	25
*****	1/2-13 X 7	SEMI-STD	*****	3/4-10 X 3 1/4	SEMI-STD
*****	1/2-13 X 8	SEMI-STD	*****	3/4-10 X 3 1/2	SEMI-STD
SF062010	5/8-11 X 1	SEMI-STD	SF075040	3/4-10 X 4	SEMI-STD
SF062012	5/8-11 X 1 1/4	50	SF075045	3/4-10 X 4 1/2	SEMI-STD
SF062015	5/8-11 X 1 1/2	50	*****	3/4-10 X 5	SEMI-STD
SF062017	5/8-11 X 1 3/4	50	*****	3/4-10 X 6	SEMI-STD
SF062020	5/8-11 X 2	50	*****	3/4-10 X 6 1/2	SEMI-STD
SF062022	5/8-11 X 2 1/4	25	*****	3/4-10 X 7	SEMI-STD
SF062025	5/8-11 X 2 1/2	25	SF075080	3/4-10 X 8	SEMI-STD
SF062027	5/8-11 X 2 3/4	SEMI-STD	*****	7/8-9 X 2	SEMI-STD
SF062030	5/8-11 X 3	25	SF087025	7/8-9 X 2 1/2	SEMI-STD
SF062035	5/8-11 X 3 1/2	SEMI-STD	*****	7/8-9 X 3	SEMI-STD
*****	5/8-11 X 4	SEMI-STD	*****	7/8-9 X 3 1/2	SEMI-STD
SF062045	5/8-11 X 4 1/2	SEMI-STD	*****	7/8-9 X 4	SEMI-STD
*****	5/8-11 X 5	SEMI-STD	SF087045	7/8-9 X 4 1/2	SEMI-STD
*****	5/8-11 X 6	SEMI-STD	*****	7/8-9 X 5	SEMI-STD
*****	5/8-11 X 6 1/2	SEMI-STD	*****	7/8-9 X 6	SEMI-STD
*****	5/8-11 X 7	SEMI-STD	*****	7/8-9 X 6 1/2	SEMI-STD
*****	5/8-11 X 8	SEMI-STD	*****	7/8-9 X 7	SEMI-STD
*****	3/4-10 X 1	SEMI-STD	*****	7/8-9 X 8	SEMI-STD
SF075012	3/4-10 X 1 1/4	25	*****	1-8 X 2	SEMI-STD
SF075015	3/4-10 X 1 1/2	25	*****	1-8 X 2 1/4	SEMI-STD
SF075017	3/4-10 X 1 3/4	25	*****	1-8 X 2 1/2	SEMI-STD
SF075020	3/4-10 X 2	25	*****	1-8 X 2 3/4	SEMI-STD

SEMI-STD PLUSIEURS QUANTITÉS DISPONIBLES / SEMI-STD PACKAGING ANY QUANTITY



Tel.: (819) 346-2903 / (888) 345-2903 Fax.: (819) 346-3389  
 Email: distributeur@boulonstrie.com

**VIS À TÊTE FRAISÉE  
À 6 PANS CREUX  
GROS FILETS**

**NOIR / BARE  
ALLOY STEEL**

**FLAT HEAD SOCKET  
CAP SCREWS  
NATIONAL COARSE**

**LA FINITION PLAQUÉE ZINC  
EST DISPONIBLE  
SUR DEMANDE**

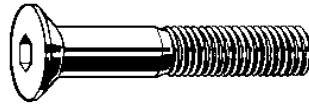

**ZINC PLATED IS  
AVAILABLE ON REQUEST**

NOTRE CODE	DESCRIPTION	QTÉ/BTE	NOTRE CODE	DESCRIPTION	QTÉ/BTE
OUR CODE	DESCRIPTION	QTY/BOX	OUR CODE	DESCRIPTION	QTY/BOX
SF090030	1-8 X 3	SEMI-STD	*****	1-8 X 8	SEMI-STD
*****	1-8 X 3 1/2	SEMI-STD	*****	1 1/4-7 X 3	SEMI-STD
SF090040	1-8 X 4	SEMI-STD	*****	1 1/4-7 X 3 1/2	SEMI-STD
*****	1-8 X 4 1/2	SEMI-STD	*****	1 1/4-7 X 4	SEMI-STD
*****	1-8 X 5	SEMI-STD	*****	1 1/4-7 X 5	SEMI-STD
*****	1-8 X 6	SEMI-STD	*****	1 1/4-7 X 6	SEMI-STD
*****	1-8 X 6 1/2	SEMI-STD	*****	1 1/4-7 X 7	SEMI-STD
*****	1-8 X 7	SEMI-STD	*****	1 1/4-7 X 8	SEMI-STD

**SEMI-STD PLUSIEURS QUANTITÉS DISPONIBLES / SEMI-STD PACKAGING ANY QUANTITY**



**Tel.: (819) 346-2903 / (888) 345-2903 Fax.: (819) 346-3389  
Email: distributeur@boulonsestrie.com**

**B-36**

VIS À TÊTE FRAISÉE  
À 6 PANS CREUX  
FILETS FINS

NOIR / BARE  
ALLOY STEEL

FLAT HEAD SOCKET  
CAP SCREWS  
NATIONAL FINE

LA FINITION PLAQUÉE ZINC  
EST DISPONIBLE  
SUR DEMANDE

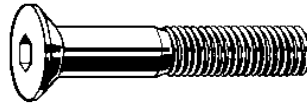

ZINC PLATED IS  
AVAILABLE ON REQUEST

NOTRE CODE	DESCRIPTION	QTÉ/BTE	NOTRE CODE	DESCRIPTION	QTÉ/BTE
OUR CODE	DESCRIPTION	QTY/BOX	OUR CODE	DESCRIPTION	QTY/BOX
*****	0-80 X 1/8	100	*****	6-40 X 3/4	SEMI-STD
*****	0-80 X 3/16	100	SF106010	6-40 X 1	SEMI-STD
*****	0-80 X 1/4	100	*****	8-36 X 3/8	SEMI-STD
*****	0-80 X 5/16	SEMI-STD	SF108005	8-36 X 1/2	SEMI-STD
*****	0-80 X 3/8	SEMI-STD	*****	8-36 X 5/8	SEMI-STD
*****	0-80 X 1/2	SEMI-STD	*****	8-36 X 3/4	SEMI-STD
*****	0-80 X 5/8	SEMI-STD	SF108010	8-36 X 1	SEMI-STD
*****	0-80 X 3/4	SEMI-STD	SF110002	10-32 X 1/4	100
*****	0-80 X 1	SEMI-STD	*****	10-32 X 5/16	100
SF101012	1-72 X 1/8	100	SF110003	10-32 X 3/8	SEMI-STD
*****	1-72 X 3/16	100	*****	10-32 X 7/16	SEMI-STD
*****	1-72 X 1/4	100	SF110005	10-32 X 1/2	100
*****	1-72 X 5/16	SEMI-STD	SF110006	10-32 X 5/8	100
*****	1-72 X 3/8	100	SF110007	10-32 X 3/4	100
*****	1-72 X 1/2	SEMI-STD	*****	10-32 X 7/8	SEMI-STD
*****	1-72 X 5/8	SEMI-STD	SF110010	10-32 X 1	100
*****	1-72 X 3/4	SEMI-STD	*****	10-32 X 1 1/8	SEMI-STD
*****	1-72 X 1	SEMI-STD	SF110012	10-32 X 1 1/4	100
*****	4-48 X 1/4	SEMI-STD	SF110015	10-32 X 1 1/2	100
*****	4-48 X 3/8	SEMI-STD	SF110017	10-32 X 1 3/4	SEMI-STD
*****	4-48 X 1/2	SEMI-STD	SF110020	10-32 X 2	SEMI-STD
*****	4-48 X 5/8	SEMI-STD	*****	10-32 X 2 1/4	SEMI-STD
*****	4-48 X 3/4	SEMI-STD	SF110025	10-32 X 2 1/2	SEMI-STD
*****	4-48 X 1	SEMI-STD	*****	10-32 X 3	SEMI-STD
SF106002	6-40 X 1/4	SEMI-STD	SF125004	1/4-28 X 3/8	100
SF106004	6-40 X 3/8	SEMI-STD	SF125005	1/4-28 X 1/2	100
SF106005	6-40 X 1/2	SEMI-STD	SF125006	1/4-28 X 5/8	100
SF106006	6-40 X 5/8	SEMI-STD	SF125007	1/4-28 X 3/4	100

SEMI-STD PLUSIEURS QUANTITÉS DISPONIBLES / SEMI-STD PACKAGING ANY QUANTITY



Tel.: (819) 346-2903 / (888) 345-2903 Fax.: (819) 346-3389

Email: distributeur@boulonstrie.com

B-37

VIS À TÊTE FRAISÉE  
À 6 PANS CREUX  
FILETS FINS

NOIR / BARE  
ALLOY STEEL

FLAT HEAD SOCKET  
CAP SCREWS  
NATIONAL FINE

LA FINITION PLAQUÉE ZINC  
EST DISPONIBLE  
SUR DEMANDE

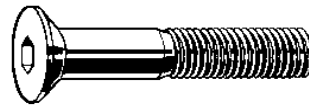

ZINC PLATED IS  
AVAILABLE ON REQUEST

NOTRE CODE	DESCRIPTION	QTÉ/BTE	NOTRE CODE	DESCRIPTION	QTÉ/BTE
OUR CODE	DESCRIPTION	QTY/BOX	OUR CODE	DESCRIPTION	QTY/BOX
SF125008	1/4-28 X 7/8	SEMI-STD	SF137010	3/8-24 X 1	100
SF125010	1/4-28 X 1	100	SF137012	3/8-24 X 1 1/4	100
SF125012	1/4-28 X 1 1/4	100	SF137015	3/8-24 X 1 1/2	100
SF125015	1/4-28 X 1 1/2	100	*****	3/8-24 X 1 3/4	SEMI-STD
*****	1/4-28 X 1 3/4	SEMI-STD	*****	3/8-24 X 2	SEMI-STD
*****	1/4-28 X 2	SEMI-STD	*****	3/8-24 X 2 1/4	SEMI-STD
*****	1/4-28 X 2 1/4	SEMI-STD	*****	3/8-24 X 2 1/2	SEMI-STD
*****	1/4-28 X 2 1/2	SEMI-STD	*****	3/8-24 X 2 3/4	SEMI-STD
*****	1/4-28 X 3	SEMI-STD	*****	3/8-24 X 3	SEMI-STD
*****	1/4-28 X 3 1/2	SEMI-STD	*****	3/8-24 X 3 1/4	SEMI-STD
SF131004	5/16-24 X 3/8	SEMI-STD	*****	3/8-24 X 3 1/2	SEMI-STD
SF131005	5/16-24 X 1/2	100	*****	7/16-20 X 3/4	SEMI-STD
SF131006	5/16-24 X 5/8	100	SF143010	7/16-20 X 1	SEMI-STD
SF131007	5/16-24 X 3/4	100	*****	7/16-20 X 1 1/4	SEMI-STD
*****	5/16-24 X 7/8	SEMI-STD	*****	7/16-20 X 1 1/2	SEMI-STD
SF131010	5/16-24 X 1	100	*****	7/16-20 X 1 3/4	SEMI-STD
SF131012	5/16-24 X 1 1/4	100	SF143020	7/16-20 X 2	SEMI-STD
SF131015	5/16-24 X 1 1/2	100	*****	7/16-20 X 2 1/2	SEMI-STD
*****	5/16-24 X 1 3/4	SEMI-STD	*****	7/16-20 X 3	SEMI-STD
*****	5/16-24 X 2	SEMI-STD	SF150007	1/2-20 X 3/4	100
*****	5/16-24 X 2 1/4	SEMI-STD	SF150010	1/2-20 X 1	100
*****	5/16-24 X 2 1/2	SEMI-STD	*****	1/2-20 X 1 1/4	100
*****	5/16-24 X 3	SEMI-STD	SF150015	1/2-20 X 1 1/2	100
*****	5/16-24 X 3 1/2	SEMI-STD	SF150017	1/2-20 X 1 3/4	100
*****	3/8-24 X 1/2	SEMI-STD	*****	1/2-20 X 2	100
SF137006	3/8-24 X 5/8	100	*****	1/2-20 X 2 1/4	SEMI-STD
SF137007	3/8-24 X 3/4	100	*****	1/2-20 X 2 1/2	SEMI-STD
*****	3/8-24 X 7/8	SEMI-STD	*****	1/2-20 X 3	SEMI-STD

SEMI-STD PLUSIEURS QUANTITÉS DISPONIBLES / SEMI-STD PACKAGING ANY QUANTITY



Tel.: (819) 346-2903 / (888) 345-2903 Fax.: (819) 346-3389

Email: distributeur@boulonstrie.com

B-38

VIS À TÊTE FRAISÉE  
 À 6 PANS CREUX  
 FILETS FINS

NOIR / BARE  
 ALLOY STEEL

FLAT HEAD SOCKET  
 CAP SCREWS  
 NATIONAL FINE

LA FINITION PLAQUÉE ZINC  
 EST DISPONIBLE  
 SUR DEMANDE

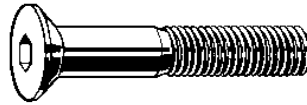

ZINC PLATED IS  
 AVAILABLE ON REQUEST

NOTRE CODE	DESCRIPTION	QTÉ/BTE	NOTRE CODE	DESCRIPTION	QTÉ/BTE
OUR CODE	DESCRIPTION	QTY/BOX	OUR CODE	DESCRIPTION	QTY/BOX
*****	1/2-20 X 3 1/2	SEMI-STD	*****	5/8-18 X 4	SEMI-STD
*****	1/2-20 X 4	SEMI-STD	*****	3/4-16 X 1 1/4	SEMI-STD
*****	5/8-18 X 1	SEMI-STD	SF175015	3/4-16 X 1 1/2	SEMI-STD
*****	5/8-18 X 1 1/4	SEMI-STD	*****	3/4-16 X 1 3/4	SEMI-STD
*****	5/8-18 X 1 1/2	SEMI-STD	*****	3/4-16 X 2	SEMI-STD
SF162017	5/8-18 X 1 3/4	SEMI-STD	*****	3/4-16 X 2 1/4	SEMI-STD
SF162020	5/8-18 X 2	SEMI-STD	*****	3/4-16 X 2 1/2	SEMI-STD
*****	5/8-18 X 2 1/4	SEMI-STD	*****	3/4-16 X 3	SEMI-STD
*****	5/8-18 X 2 1/2	SEMI-STD	*****	3/4-16 X 3 1/2	SEMI-STD
*****	5/8-18 X 3	SEMI-STD	*****	3/4-16 X 4	SEMI-STD
SF162035	5/8-18 X 3 1/2	SEMI-STD			

SEMI-STD PLUSIEURS QUANTITÉS DISPONIBLES / SEMI-STD PACKAGING ANY QUANTITY



Tel.: (819) 346-2903 / (888) 345-2903 Fax.: (819) 346-3389

Email: distributeur@boulonsestrie.com

B-39

VIS À TÊTE FRAISÉE  
À 6 PANS CREUX  
GROS FILETS

SS-304  
18-8

FLAT HEAD SOCKET  
CAP SCREWS  
NATIONAL COARSE

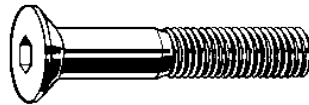

NOTRE CODE	DESCRIPTION	QTÉ/BTE	NOTRE CODE	DESCRIPTION	QTÉ/BTE
OUR CODE	DESCRIPTION	QTY/BOX	OUR CODE	DESCRIPTION	QTY/BOX
SF404004	4-40 X 3/8	100	SF425005	1/4-20 X 1/2	100
SF404005	4-40 X 1/2	100	SF425006	1/4-20 X 5/8	100
SF404007	4-40 X 3/4	100	SF425007	1/4-20 X 3/4	100
SF406002	6-32 X 1/4	100	SF425010	1/4-20 X 1	100
SF406004	6-32 X 3/8	100	SF425012	1/4-20 X 1 1/4	100
SF406005	6-32 X 1/2	100	SF425015	1/4-20 X 1 1/2	100
SF406007	6-32 X 3/4	100	SF425017	1/4-20 X 1 3/4	100
SF406020	6-32 X 2	100	SF425020	1/4-20 X 2	100
SF408004	8-32 X 3/8	100	SF425025	1/4-20 X 2 1/2	100
SF408005	8-32 X 1/2	100	SF431005	5/16-18 X 1/2	100
SF408007	8-32 X 3/4	100	SF431006	5/16-18 X 5/8	100
SF410004	10-24 X 3/8	100	SF431007	5/16-18 X 3/4	100
SF410005	10-24 X 1/2	100	SF431010	5/16-18 X 1	100
SF410007	10-24 X 3/4	100	SF431012	5/16-18 X 1 1/4	100
SF410010	10-24 X 1	100	SF431015	5/16-18 X 1 1/2	100
SF410012	10-24 X 1 1/4	100	SF431017	5/16-18 X 1 3/4	100
SF410015	10-24 X 1 1/2	100	SF431020	5/16-18 X 2	100
SF410020	10-24 X 2	100	SF431025	5/16-18 X 2 1/2	100
SF411002	10-32 X 1/4	100	SF431030	5/16-18 X 3	100
SF411004	10-32 X 3/8	100	SF437005	3/8-16 X 1/2	100
SF411005	10-32 X 1/2	100	SF437007	3/8-16 X 3/4	100
SF411006	10-32 X 5/8	100	SF437008	3/8-16 X 7/8	100
SF411007	10-32 X 3/4	100	SF437010	3/8-16 X 1	100
SF411010	10-32 X 1	100	SF437012	3/8-16 X 1 1/4	100
SF411012	10-32 X 1 1/4	100	SF437014	3/8-16 X 1 3/8	100
SF411015	10-32 X 1 1/2	100	SF437015	3/8-16 X 1 1/2	100
SF411017	10-32 X 1 3/4	100	SF437017	3/8-16 X 1 3/4	100
SF425004	1/4-20 X 3/8	100	SF437020	3/8-16 X 2	100

AUTRES DIMENSIONS DISPONIBLES / OTHER DIMENSIONS ARE AVAILABLE



Tel.: (819) 346-2903 / (888) 345-2903 Fax.: (819) 346-3389

Email: distributeur@boulonstrie.com

B-40

VIS À TÊTE FRAISÉE  
À 6 PANS CREUX  
GROS FILETS

SS-304  
18-8

FLAT HEAD SOCKET  
CAP SCREWS  
NATIONAL COARSE

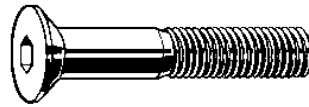

NOTRE CODE	DESCRIPTION	QTÉ/BTE	NOTRE CODE	DESCRIPTION	QTÉ/BTE
OUR CODE	DESCRIPTION	QTY/BOX	OUR CODE	DESCRIPTION	QTY/BOX
SF437022	3/8-16 X 2 1/4	50	SF450017	1/2-13 X 1 3/4	50
SF437025	3/8-16 X 2 1/2	50	SF450020	1/2-13 X 2	50
SF437027	3/8-16 X 2 3/4	50	SF450025	1/2-13 X 2 1/2	50
SF437030	3/8-16 X 3	50	SF450035	1/2-13 X 3 1/2	50
SF450007	1/2-13 X 3/4	50	SF462015	5/8-11 X 1 1/2	25
SF450010	1/2-13 X 1	50	SF462017	5/8-11 X 1 3/4	25
SF450012	1/2-13 X 1 1/4	50	SF462025	5/8-11 X 2 1/2	25
SF450015	1/2-13 X 1 1/2	50	SF475025	3/4-10 X 2 1/2	20

AUTRES DIMENSIONS DISPONIBLES / OTHER DIMENSIONS ARE AVAILABLE

AUSSI DISPONIBLE / ALSO AVAILABLE

ACIER INOXYDABLE SS-316 STAINLESS STEEL



Tel.: (819) 346-2903 / (888) 345-2903 Fax.: (819) 346-3389

Email: distributeur@boulonsestrie.com

B-41

VIS À TÊTE PLATE  
 À 6 PANS CREUX  
 GROS FILETS

GRADE 10.9  
 NOIR / BARE

FLAT HEAD SOCKET  
 CAP SCREWS  
 NATIONAL COARSE

MÉTRIQUE DIN 7991 METRIC

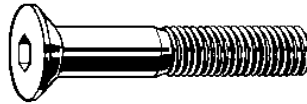

NOTRE CODE	DESCRIPTION	QTÉ/BTE	NOTRE CODE	DESCRIPTION	QTÉ/BTE
OUR CODE	DESCRIPTION	QTY/BOX	OUR CODE	DESCRIPTION	QTY/BOX
SF303006	M3 X .50 X 6	100	SF306010	M6 X 1.00 X 10	100
SF303008	M3 X .50 X 8	100	SF306012	M6 X 1.00 X 12	100
SF303010	M3 X .50 X 10	100	*****	M6 X 1.00 X 14	100
SF303012	M3 X .50 X 12	100	*****	M6 X 1.00 X 15	100
SF303016	M3 X .50 X 16	100	SF306016	M6 X 1.00 X 16	100
SF303020	M3 X .50 X 20	100	SF306018	M6 X 1.00 X 18	100
SF303025	M3 X .50 X 25	100	SF306020	M6 X 1.00 X 20	100
SF304008	M4 X .70 X 8	100	SF306025	M6 X 1.00 X 25	100
SF304010	M4 X .70 X 10	100	SF306030	M6 X 1.00 X 30	100
SF304012	M4 X .70 X 12	100	SF306035	M6 X 1.00 X 35	100
SF304016	M4 X .70 X 16	100	SF306040	M6 X 1.00 X 40	100
SF304020	M4 X .70 X 20	100	*****	M6 X 1.00 X 45	100
SF304025	M4 X .70 X 25	100	*****	M6 X 1.00 X 50	100
SF304030	M4 X .70 X 30	100	SF308010	M8 X 1.25 X 10	50
SF304035	M4 X .70 X 35	100	SF308012	M8 X 1.25 X 12	50
SF305008	M5 X .80 X 8	100	*****	M8 X 1.25 X 15	50
SF305010	M5 X .80 X 10	100	SF308016	M8 X 1.25 X 16	50
SF305012	M5 X .80 X 12	100	SF308018	M8 X 1.25 X 18	50
SF305016	M5 X .80 X 16	100	SF308020	M8 X 1.25 X 20	50
SF305020	M5 X .80 X 20	100	SF308025	M8 X 1.25 X 25	50
SF305025	M5 X .80 X 25	100	SF308030	M8 X 1.25 X 30	50
SF305030	M5 X .80 X 30	100	SF308035	M8 X 1.25 X 35	50
SF305035	M5 X .80 X 35	100	SF308040	M8 X 1.25 X 40	50
SF305040	M5 X .80 X 40	100	*****	M8 X 1.25 X 45	-
SF305050	M5 X .80 X 50	100	SF308050	M8 X 1.25 X 50	50
SF306008	M6 X 1.00 X 8	100	*****	M8 X 1.25 X 55	-

AUTRES DIMENSIONS DISPONIBLES/OTHER DIMENSIONS ARE AVAILABLE



Tel.: (819) 346-2903 / (888) 345-2903 Fax.: (819) 346-3389

Email: distributeur@boulonstrie.com



VIS À TÊTE PLATE  
À 6 PANS CREUX  
GROS FILETS

GRADE 10.9  
NOIR / BARE

FLAT HEAD SOCKET  
CAP SCREWS  
NATIONAL COARSE

MÉTRIQUE DIN 7991 METRIC

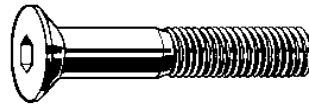

NOTRE CODE	DESCRIPTION	QTÉ/BTE	NOTRE CODE	DESCRIPTION	QTÉ/BTE
OUR CODE	DESCRIPTION	QTY/BOX	OUR CODE	DESCRIPTION	QTY/BOX
SF308060	M8 X 1.25 X 60	50	SF312045	M12 X 1.75 X 45	25
SF308070	M8 X 1.25 X 70	50	SF312050	M12 X 1.75 X 50	25
SF310012	M10 X 1.50 X 12	25	*****	M12 X 1.75 X 55	25
*****	M10 X 1.50 X 15	25	SF312060	M12 X 1.75 X 60	25
*****	M10 X 1.50 X 14	25	SF312070	M12 X 1.75 X 70	25
SF310016	M10 X 1.50 X 16	25	SF312080	M12 X 1.75 X 80	25
*****	M10 X 1.50 X 18	25	*****	M12 X 1.75 X 90	25
SF310020	M10 X 1.50 X 20	25	*****	M12 X 1.75 X 100	25
SF310025	M10 X 1.50 X 25	25	SF316025	M16 X 2.00 X 25	20
SF310030	M10 X 1.50 X 30	25	SF316030	M16 X 2.00 X 30	20
SF310035	M10 X 1.50 X 35	25	*****	M16 X 2.00 X 35	20
SF310040	M10 X 1.50 X 40	25	SF316040	M16 X 2.00 X 40	20
*****	M10 X 1.50 X 45	25	*****	M16 X 2.00 X 45	20
SF310050	M10 X 1.50 X 50	25	SF316050	M16 X 2.00 X 50	20
*****	M10 X 1.50 X 55	25	*****	M16 X 2.00 X 55	20
SF310060	M10 X 1.50 X 60	25	*****	M16 X 2.00 X 60	20
*****	M10 X 1.50 X 70	25	SF316070	M16 X 2.00 X 70	20
SF310075	M10 X 1.50 X 75	25	*****	M16 X 2.00 X 80	20
*****	M10 X 1.50 X 80	25	*****	M16 X 2.00 X 90	20
*****	M10 X 1.50 X 90	25	*****	M16 X 2.00 X 100	20
*****	M10 X 1.50 X 100	25	*****	M20 X 2.50 X 35	15
SF312020	M12 X 1.75 X 20	25	*****	M20 X 2.50 X 40	15
SF312025	M12 X 1.75 X 25	25	*****	M20 X 2.50 X 45	15
SF312030	M12 X 1.75 X 30	25	SF320050	M20 X 2.50 X 50	15
SF312035	M12 X 1.75 X 35	25	*****	M20 X 2.50 X 55	15
SF312040	M12 X 1.75 X 40	25	SF320060	M20 X 2.50 X 60	15

AUTRES DIMENSIONS DISPONIBLES/OTHER DIMENSIONS ARE AVAILABLE



Tel.: (819) 346-2903 / (888) 345-2903 Fax.: (819) 346-3389

Email: distributeur@boulonstrie.com

**VIS À TÊTE PLATE  
À 6 PANS CREUX  
GROS FILETS**

**GRADE 10.9  
NOIR / BARE**

**FLAT HEAD SOCKET  
CAP SCREWS  
NATIONAL COARSE**

**MÉTRIQUE DIN 7991 METRIC**

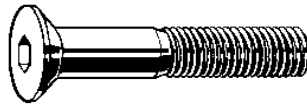

<b>NOTRE CODE</b>	<b>DESCRIPTION</b>	<b>QTÉ/BTE</b>	<b>NOTRE CODE</b>	<b>DESCRIPTION</b>	<b>QTÉ/BTE</b>
<b>OUR CODE</b>	<b>DESCRIPTION</b>	<b>QTY/BOX</b>	<b>OUR CODE</b>	<b>DESCRIPTION</b>	<b>QTY/BOX</b>
<b>SF320070</b>	<b>M20 X 2.50 X 70</b>	<b>15</b>	<b>*****</b>	<b>M20 X 2.50 X 90</b>	<b>15</b>
<b>*****</b>	<b>M20 X 2.50 X 80</b>	<b>15</b>	<b>*****</b>	<b>M20 X 2.50 X 100</b>	<b>15</b>

**AUTRES DIMENSIONS DISPONIBLES/OTHER DIMENSIONS ARE AVAILABLE**

**AUSSI DISPONIBLE / ALSO AVAILABLE**

**VIS À TÊTE FRAISÉE À 6 PANS CREUX,  
MÉTRIQUE, DIN 7991, A2 (304).**

**FLAT HEAD SOCKET CAP SCREWS,  
METRIC, DIN 7991, A2 (304).**



**Tel.: (819) 346-2903 / (888) 345-2903 Fax.: (819) 346-3389**

**Email: distributeur@boulonsestrie.com**

**B-44**

VIS DE PRESSION  
À 6 PANS CREUX  
GROS FILETS

NOIR / BARE  
ALLOY STEEL

SOCKET SET SCREWS  
CUP POINT  
NATIONAL COARSE

LA FINITION PLAQUÉE ZINC  
EST DISPONIBLE  
SUR DEMANDE



ZINC PLATED IS  
AVAILABLE ON REQUEST

NOTRE CODE	DESCRIPTION	QTÉ/BTE	NOTRE CODE	DESCRIPTION	QTÉ/BTE
OUR CODE	DESCRIPTION	QTY/BOX	OUR CODE	DESCRIPTION	QTY/BOX
*****	2-56 X 1/16	100	SS104062	4-40 X 5/8	100
*****	2-56 X 3/32	100	*****	4-40 X 3/4	SEMI-STD
*****	2-56 X 1/8	100	*****	4-40 X 7/8	SEMI-STD
*****	2-56 X 5/32	SEMI-STD	*****	4-40 X 1	SEMI-STD
SS102018	2-56 X 3/16	100	SS105012	5-40 X 1/8	100
SS102025	2-56 X 1/4	100	SS105018	5-40 X 3/16	100
*****	2-56 X 5/16	SEMI-STD	SS105025	5-40 X 1/4	100
*****	2-56 X 3/8	SEMI-STD	SS105031	5-40 X 5/16	100
*****	2-56 X 1/2	SEMI-STD	SS105037	5-40 X 3/8	100
*****	2-56 X 5/8	SEMI-STD	*****	5-40 X 7/16	SEMI-STD
*****	2-56 X 3/4	SEMI-STD	SS105050	5-40 X 1/2	100
*****	3-48 X 1/16	SEMI-STD	SS105062	5-40 X 5/8	100
*****	3-48 X 5/32	SEMI-STD	SS105075	5-40 X 3/4	100
*****	3-48 X 3/32	100	*****	5-40 X 7/8	SEMI-STD
*****	3-48 X 1/8	100	*****	5-40 X 1	SEMI-STD
SS103018	3-48 X 3/16	100	SS106012	6-32 X 1/8	100
SS103025	3-48 X 1/4	100	SS106018	6-32 X 3/16	100
*****	3-48 X 5/16	SEMI-STD	SS106025	6-32 X 1/4	100
*****	3-48 X 3/8	SEMI-STD	SS106031	6-32 X 5/16	100
*****	3-48 X 1/2	SEMI-STD	SS106037	6-32 X 3/8	100
*****	3-48 X 5/8	SEMI-STD	SS106043	6-32 X 7/16	100
SS104012	4-40 X 1/8	100	SS106050	6-32 X 1/2	100
SS104018	4-40 X 3/16	100	SS106062	6-32 X 5/8	100
SS104025	4-40 X 1/4	100	SS106075	6-32 X 3/4	100
*****	4-40 X 5/16	100	SS106087	6-32 X 7/8	100
SS104037	4-40 X 3/8	100	SS106100	6-32 X 1	100
*****	4-40 X 7/16	SEMI-STD	*****	6-32 X 1 1/4	SEMI-STD
SS104050	4-40 X 1/2	100	*****	6-32 X 1 1/2	SEMI-STD

SEMI-STD PLUSIEURS QUANTITÉS DISPONIBLES / SEMI-STD PACKAGING ANY QUANTITY



Tel.: (819) 346-2903 / (888) 345-2903 Fax.: (819) 346-3389  
Email: distributeur@boulonsestrie.com

B-45

LA FINITION PLAQUÉE ZINC  
EST DISPONIBLE  
SUR DEMANDE



ZINC PLATED IS  
AVAILABLE ON REQUEST

NOTRE CODE	DESCRIPTION	QTÉ/BTE	NOTRE CODE	DESCRIPTION	QTÉ/BTE
OUR CODE	DESCRIPTION	QTY/BOX	OUR CODE	DESCRIPTION	QTY/BOX
*****	6-32 X 1 3/4	SEMI-STD	SS110125	10-24 X 1 1/4	100
*****	6-32 X 2	SEMI-STD	SS110150	10-24 X 1 1/2	SEMI-STD
SS108012	8-32 X 1/8	100	*****	10-24 X 1 3/4	SEMI-STD
SS108018	8-32 X 3/16	100	*****	10-24 X 2	SEMI-STD
SS108025	8-32 X 1/4	100	*****	10-24 X 2 1/2	SEMI-STD
SS108031	8-32 X 5/16	100	*****	12-24 X 3/16	SEMI-STD
SS108037	8-32 X 3/8	100	*****	12-24 X 1/4	SEMI-STD
SS108043	8-32 X 7/16	100	*****	12-24 X 5/16	SEMI-STD
SS108050	8-32 X 1/2	100	*****	12-24 X 3/8	SEMI-STD
SS108062	8-32 X 5/8	100	*****	12-24 X 1/2	SEMI-STD
SS108075	8-32 X 3/4	100	*****	12-24 X 5/8	SEMI-STD
SS108087	8-32 X 7/8	100	*****	12-24 X 3/4	SEMI-STD
SS108100	8-32 X 1	100	*****	12-24 X 1	SEMI-STD
*****	8-32 X 1 1/4	SEMI-STD	SS125018	1/4-20 X 3/16	100
*****	8-32 X 1 1/2	SEMI-STD	SS125025	1/4-20 X 1/4	100
*****	8-32 X 1 3/4	SEMI-STD	SS125031	1/4-20 X 5/16	100
*****	8-32 X 2	SEMI-STD	SS125037	1/4-20 X 3/8	100
*****	10-24 X 1/8	SEMI-STD	*****	1/4-20 X 7/16	100
SS110018	10-24 X 3/16	100	SS125050	1/4-20 X 1/2	100
SS110025	10-24 X 1/4	100	SS125062	1/4-20 X 5/8	100
SS110031	10-24 X 5/16	100	SS125075	1/4-20 X 3/4	100
SS110037	10-24 X 3/8	100	SS125087	1/4-20 X 7/8	100
SS110043	10-24 X 7/16	100	SS125100	1/4-20 X 1	100
SS110050	10-24 X 1/2	100	*****	1/4-20 X 1 1/8	SEMI-STD
SS110062	10-24 X 5/8	100	SS125125	1/4-20 X 1 1/4	100
SS110075	10-24 X 3/4	100	SS125150	1/4-20 X 1 1/2	100
SS110087	10-24 X 7/8	100	SS125175	1/4-20 X 1 3/4	100
SS110100	10-24 X 1	100	SS125200	1/4-20 X 2	100

SEMI-STD PLUSIEURS QUANTITÉS DISPONIBLES / SEMI-STD PACKAGING ANY QUANTITY



Tel.: (819) 346-2903 / (888) 345-2903 Fax.: (819) 346-3389  
Email: distributeur@boulonsestrie.com

VIS DE PRESSION  
À 6 PANS CREUX  
GROS FILETS

NOIR / BARE  
ALLOY STEEL

SOCKET SET SCREWS  
CUP POINT  
NATIONAL COARSE

LA FINITION PLAQUÉE ZINC  
EST DISPONIBLE  
SUR DEMANDE



ZINC PLATED IS  
AVAILABLE ON REQUEST

NOTRE CODE	DESCRIPTION	QTÉ/BTE	NOTRE CODE	DESCRIPTION	QTÉ/BTE
OUR CODE	DESCRIPTION	QTY/BOX	OUR CODE	DESCRIPTION	QTY/BOX
***** SS125250 *****	1/4-20 X 2 1/4 1/4-20 X 2 1/2 1/4-20 X 2 3/4	SEMI-STD SEMI-STD SEMI-STD	SS137087 SS137100 SS137125 SS137150	3/8-16 X 7/8 3/8-16 X 1 3/8-16 X 1 1/4 3/8-16 X 1 1/2	100 100 100 100
SS131025 SS131031 SS131037 SS131043 SS131050 SS131062 SS131075 SS131087 SS131100 SS131125 SS131150 SS131175 SS131200 SS131225 ***** *****	5/16-18 X 1/4 5/16-18 X 5/16 5/16-18 X 3/8 5/16-18 X 7/16 5/16-18 X 1/2 5/16-18 X 5/8 5/16-18 X 3/4 5/16-18 X 7/8 5/16-18 X 1 5/16-18 X 1 1/4 5/16-18 X 1 1/2 5/16-18 X 1 3/4 5/16-18 X 2 5/16-18 X 2 1/4 5/16-18 X 2 1/2 5/16-18 X 2 3/4	100 100 100 100 100 100 100 100 100 100 100 100 100 SEMI-STD SEMI-STD SEMI-STD	SS137175 SS137200 ***** SS137250 SS137275 ***** ***** ***** SS143037 ***** SS143050 SS143062 SS143075 SS143087 SS143100 SS143125 SS143150 SS143175 SS143200 ***** ***** ***** *****	3/8-16 X 1 3/4 3/8-16 X 2 3/8-16 X 2 1/4 3/8-16 X 2 1/2 3/8-16 X 2 3/4 3/8-16 X 3 3/8-16 X 3 1/2 3/8-16 X 4 7/16-14 X 3/8 7/16-14 X 7/16 7/16-14 X 1/2 7/16-14 X 5/8 7/16-14 X 3/4 7/16-14 X 7/8 7/16-14 X 1 7/16-14 X 1 1/4 7/16-14 X 1 1/2 7/16-14 X 1 3/4 7/16-14 X 2 7/16-14 X 2 1/4 7/16-14 X 2 1/2 7/16-14 X 2 3/4 7/16-14 X 3	100 100 SEMI-STD 100 SEMI-STD SEMI-STD SEMI-STD SEMI-STD 100 100 100 100 100 100 100 100 100 100 100 SEMI-STD 100 SEMI-STD SEMI-STD SEMI-STD SEMI-STD
SS131300	5/16-18 X 3	SEMI-STD	SS150037	1/2-13 X 3/8	100
SS137025 SS137031 SS137037 SS137043 SS137050 SS137062 SS137075	3/8-16 X 1/4 3/8-16 X 5/16 3/8-16 X 3/8 3/8-16 X 7/16 3/8-16 X 1/2 3/8-16 X 5/8 3/8-16 X 3/4	100 100 100 100 100 100 100			

SEMI-STD PLUSIEURS QUANTITÉS DISPONIBLES / SEMI-STD PACKAGING ANY QUANTITY



Tel.: (819) 346-2903 / (888) 345-2903 Fax.: (819) 346-3389  
Email: distributeur@boulonsestrie.com

B-47

VIS DE PRESSION  
 À 6 PANS CREUX  
 GROS FILETS

NOIR / BARE  
 ALLOY STEEL

SOCKET SET SCREWS  
 CUP POINT  
 NATIONAL COARSE

LA FINITION PLAQUÉE ZINC  
 EST DISPONIBLE  
 SUR DEMANDE



ZINC PLATED IS  
 AVAILABLE ON REQUEST

NOTRE CODE	DESCRIPTION	QTÉ/BTE	NOTRE CODE	DESCRIPTION	QTÉ/BTE
OUR CODE	DESCRIPTION	QTY/BOX	OUR CODE	DESCRIPTION	QTY/BOX
SS150043	1/2-13 X 7/16	100	SS162200	5/8-11 X 2	50
SS150050	1/2-13 X 1/2	100	*****	5/8-11 X 2 1/4	SEMI-STD
SS150062	1/2-13 X 5/8	100	SS162250	5/8-11 X 2 1/2	50
SS150075	1/2-13 X 3/4	100	*****	5/8-11 X 2 3/4	SEMI-STD
SS150087	1/2-13 X 7/8	100	SS162300	5/8-11 X 3	50
SS150100	1/2-13 X 1	100	*****	5/8-11 X 3 1/4	SEMI-STD
SS150125	1/2-13 X 1 1/4	100	SS162350	5/8-11 X 3 1/2	SEMI-STD
SS150150	1/2-13 X 1 1/2	100	SS162400	5/8-11 X 4	SEMI-STD
SS150175	1/2-13 X 1 3/4	50	*****	5/8-11 X 4 1/2	SEMI-STD
SS150200	1/2-13 X 2	50	*****	5/8-11 X 5	SEMI-STD
*****	1/2-13 X 2 1/4	SEMI-STD	SS162600	5/8-11 X 6	SEMI-STD
SS150250	1/2-13 X 2 1/2	50	SS175062	3/4-10 X 5/8	50
*****	1/2-13 X 2 3/4	SEMI-STD	SS175075	3/4-10 X 3/4	50
SS150300	1/2-13 X 3	50	*****	3/4-10 X 7/8	SEMI-STD
*****	1/2-13 X 3 1/2	SEMI-STD	SS175100	3/4-10 X 1	50
*****	1/2-13 X 4	SEMI-STD	SS175125	3/4-10 X 1 1/4	50
*****	1/2-13 X 4 1/2	SEMI-STD	SS175150	3/4-10 X 1 1/2	50
*****	1/2-13 X 5	SEMI-STD	SS175175	3/4-10 X 1 3/4	25
*****	1/2-13 X 5 1/2	SEMI-STD	SS175200	3/4-10 X 2	25
*****	1/2-13 X 6	SEMI-STD	*****	3/4-10 X 2 1/4	SEMI-STD
SS162050	5/8-11 X 1/2	50	SS175250	3/4-10 X 2 1/2	25
SS162062	5/8-11 X 5/8	50	SS175300	3/4-10 X 3	25
SS162075	5/8-11 X 3/4	50	SS175350	3/4-10 X 3 1/2	SEMI-STD
*****	5/8-11 X 7/8	50	*****	3/4-10 X 4	SEMI-STD
SS162100	5/8-11 X 1	50	*****	3/4-10 X 4 1/2	SEMI-STD
SS162125	5/8-11 X 1 1/4	50	SS175500	3/4-10 X 5	SEMI-STD
SS162150	5/8-11 X 1 1/2	50	SS187087	7/8-9 X 7/8	25
SS162175	5/8-11 X 1 3/4	50	SS187100	7/8-9 X 1	25

SEMI-STD PLUSIEURS QUANTITÉS DISPONIBLES / SEMI-STD PACKAGING ANY QUANTITY



Tel.: (819) 346-2903 / (888) 345-2903 Fax.: (819) 346-3389  
 Email: distributeur@boulonsestrie.com

B-48

VIS DE PRESSION  
 À 6 PANS CREUX  
 GROS FILETS

NOIR / BARE  
 ALLOY STEEL

SOCKET SET SCREWS  
 CUP POINT  
 NATIONAL COARSE

LA FINITION PLAQUÉE ZINC  
 EST DISPONIBLE  
 SUR DEMANDE

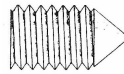
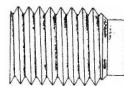
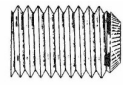
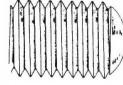
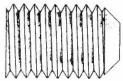

ZINC PLATED IS  
 AVAILABLE ON REQUEST

NOTRE CODE	DESCRIPTION	QTÉ/BTE	NOTRE CODE	DESCRIPTION	QTÉ/BTE
OUR CODE	DESCRIPTION	QTY/BOX	OUR CODE	DESCRIPTION	QTY/BOX
***** SS187150	7/8-9 X 1 1/4 7/8-9 X 1 1/2	SEMI-STD 25	***** *****	1 1/8-7 X 2 1/2 1 1/8-7 X 3	SEMI-STD SEMI-STD
***** SS187200	7/8-9 X 1 3/4 7/8-9 X 2	SEMI-STD 25	***** *****	1 1/4-7 X 1 1 1/4-7 X 1 1/4	SEMI-STD SEMI-STD
***** SS187250	7/8-9 X 2 1/4 7/8-9 X 2 1/2	SEMI-STD 25	***** *****	1 1/4-7 X 1 1/2 1 1/4-7 X 2	SEMI-STD SEMI-STD
***** SS187300	7/8-9 X 3 7/8-9 X 3 1/2	SEMI-STD 25	***** *****	1 1/4-7 X 2 1/2 1 1/4-7 X 3	SEMI-STD SEMI-STD
***** SS190100	7/8-9 X 4 1-8 X 1	SEMI-STD 25	***** *****	1 1/4-7 X 3 1/2 1 1/4-7 X 4	SEMI-STD SEMI-STD
***** SS190150	1-8 X 1 1/4 1-8 X 1 1/2	SEMI-STD 25	***** *****	1 1/2-6 X 1 1/2 1 1/2-6 X 2	SEMI-STD SEMI-STD
***** SS190200	1-8 X 1 3/4 1-8 X 2	SEMI-STD 25	***** *****	1 1/2-6 X 2 1/2 1 1/2-6 X 3	SEMI-STD SEMI-STD
***** SS190275	1-8 X 2 1/4 1-8 X 2 1/2	SEMI-STD 25	***** *****	1 1/2-6 X 3 1/2 1 1/2-6 X 4	SEMI-STD SEMI-STD
***** SS190300	1-8 X 2 3/4 1-8 X 3	SEMI-STD 25	<b>AUSSI DISPONIBLE/          ALSO AVAILABLE</b>  <b>CONE PT</b>   <b>HALF DOG</b>   <b>KNURLED PT</b>   <b>OVAL PT</b>   <b>FLAT PT</b> 		
*****	1-8 X 3 1/2	SEMI-STD			
*****	1-8 X 4	SEMI-STD			
*****	1-8 X 4 1/2	SEMI-STD			
*****	1-8 X 5	SEMI-STD			
*****	1-8 X 6	SEMI-STD			
*****	1 1/8-7 X 1	SEMI-STD			
*****	1 1/8-7 X 1 1/4	SEMI-STD			
*****	1 1/8-7 X 1 1/2	SEMI-STD			
*****	1 1/8-7 X 1 3/4	SEMI-STD			
*****	1 1/8-7 X 2	SEMI-STD			

SEMI-STD PLUSIEURS QUANTITÉS DISPONIBLES / SEMI-STD PACKAGING ANY QUANTITY



Tel.: (819) 346-2903 / (888) 345-2903 Fax.: (819) 346-3389  
 Email: distributeur@boulonstrie.com

VIS DE PRESSION  
À 6 PANS CREUX  
FILETS FINS

NOIR / BARE  
ALLOY STEEL

SOCKET SET SCREWS  
CUP POINT  
NATIONAL FINE

LA FINITION PLAQUÉE ZINC  
EST DISPONIBLE  
SUR DEMANDE

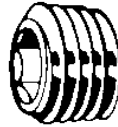

ZINC PLATED IS  
AVAILABLE ON REQUEST

NOTRE CODE	DESCRIPTION	QTÉ/BTE	NOTRE CODE	DESCRIPTION	QTÉ/BTE
OUR CODE	DESCRIPTION	QTY/BOX	OUR CODE	DESCRIPTION	QTY/BOX
*****	0-80 X 1/16	100	*****	4-48 X 7/16	SEMI-STD
*****	0-80 X 5/32	SEMI-STD	*****	4-48 X 1/2	SEMI-STD
*****	0-80 X 3/32	100	*****	4-48 X 5/8	SEMI-STD
*****	0-80 X 1/8	100	SS205012	5-44 X 1/8	100
*****	0-80 X 3/16	100	SS205018	5-44 X 3/16	100
*****	0-80 X 1/4	100	SS205025	5-44 X 1/4	100
*****	0-80 X 5/16	SEMI-STD	*****	5-44 X 5/16	SEMI-STD
*****	0-80 X 3/8	SEMI-STD	*****	5-44 X 3/8	SEMI-STD
*****	1-72 X 1/16	100	SS206012	6-40 X 1/8	100
*****	1-72 X 3/32	100	SS206018	6-40 X 3/16	100
*****	1-72 X 1/8	100	SS206025	6-40 X 1/4	100
*****	1-72 X 3/16	100	SS206031	6-40 X 5/16	100
*****	1-72 X 1/4	100	SS206037	6-40 X 3/8	100
*****	2-64 X 3/32	SEMI-STD	SS208012	8-36 X 1/8	100
*****	2-64 X 1/8	SEMI-STD	SS208018	8-36 X 3/16	100
*****	2-64 X 3/16	SEMI-STD	SS208025	8-36 X 1/4	100
*****	2-64 X 1/4	SEMI-STD	SS208031	8-36 X 5/16	100
*****	3-56 X 1/8	SEMI-STD	*****	8-36 X 3/8	100
*****	3-56 X 3/16	SEMI-STD	SS208050	8-36 X 1/2	100
*****	3-56 X 1/4	SEMI-STD	SS210012	10-32 X 1/8	SEMI-STD
*****	3-56 X 5/16	SEMI-STD	SS210018	10-32 X 3/16	100
*****	3-56 X 3/8	SEMI-STD	SS210025	10-32 X 1/4	100
*****	4-48 X 1/8	100	SS210031	10-32 X 5/16	100
*****	4-48 X 3/32	SEMI-STD	SS210037	10-32 X 3/8	100
SS204018	4-48 X 3/16	100	SS210043	10-32 X 7/16	100
*****	4-48 X 1/4	100	SS210050	10-32 X 1/2	100
*****	4-48 X 5/16	SEMI-STD	SS210062	10-32 X 5/8	100
*****	4-48 X 3/8	100	SS210075	10-32 X 3/4	100

SEMI-STD PLUSIEURS QUANTITÉS DISPONIBLES / SEMI-STD PACKAGING ANY QUANTITY



Tel.: (819) 346-2903 / (888) 345-2903 Fax.: (819) 346-3389

Email: distributeur@boulonsestrie.com

B-50



VIS DE PRESSION  
À 6 PANS CREUX  
FILETS FINS

NOIR / BARE  
ALLOY STEEL

SOCKET SET SCREWS  
CUP POINT  
NATIONAL FINE

LA FINITION PLAQUÉE ZINC  
EST DISPONIBLE  
SUR DEMANDE



ZINC PLATED IS  
AVAILABLE ON REQUEST

NOTRE CODE	DESCRIPTION	QTÉ/BTE	NOTRE CODE	DESCRIPTION	QTÉ/BTE
OUR CODE	DESCRIPTION	QTY/BOX	OUR CODE	DESCRIPTION	QTY/BOX
SS210087	10-32 X 7/8	SEMI-STD	SS231037	5/16-24 X 3/8	100
SS210100	10-32 X 1	100	*****	5/16-24 X 7/16	100
SS210125	10-32 X 1 1/4	100	SS231050	5/16-24 X 1/2	100
SS210150	10-32 X 1 1/2	SEMI-STD	*****	5/16-24 X 5/8	100
SS210175	10-32 X 1 3/4	SEMI-STD	SS231075	5/16-24 X 3/4	100
*****	10-32 X 2	SEMI-STD	*****	5/16-24 X 7/8	SEMI-STD
*****	10-32 X 2 1/2	SEMI-STD	SS231100	5/16-24 X 1	100
*****	12-28 X 1/4	SEMI-STD	SS231125	5/16-24 X 1 1/4	100
*****	12-28 X 3/8	SEMI-STD	SS231150	5/16-24 X 1 1/2	SEMI-STD
*****	12-28 X 1/2	SEMI-STD	SS231175	5/16-24 X 1 3/4	SEMI-STD
SS225018	1/4-28 X 3/16	100	*****	5/16-24 X 2	SEMI-STD
SS225025	1/4-28 X 1/4	100	*****	5/16-24 X 2 1/4	SEMI-STD
SS225031	1/4-28 X 5/16	100	*****	5/16-24 X 2 1/2	SEMI-STD
SS225037	1/4-28 X 3/8	100	SS231300	5/16-24 X 3	SEMI-STD
SS225043	1/4-28 X 7/16	100	SS237025	3/8-24 X 1/4	100
SS225050	1/4-28 X 1/2	100	SS237031	3/8-24 X 5/16	100
SS225062	1/4-28 X 5/8	100	SS237037	3/8-24 X 3/8	100
SS225075	1/4-28 X 3/4	100	SS237043	3/8-24 X 7/16	100
*****	1/4-28 X 7/8	SEMI-STD	SS237050	3/8-24 X 1/2	100
SS225100	1/4-28 X 1	100	SS237062	3/8-24 X 5/8	100
SS225125	1/4-28 X 1 1/4	100	SS237075	3/8-24 X 3/4	100
SS225150	1/4-28 X 1 1/2	SEMI-STD	SS237087	3/8-24 X 7/8	SEMI-STD
*****	1/4-28 X 1 3/4	SEMI-STD	SS237100	3/8-24 X 1	100
*****	1/4-28 X 2	SEMI-STD	SS237125	3/8-24 X 1 1/4	100
*****	1/4-28 X 2 1/2	SEMI-STD	SS237150	3/8-24 X 1 1/2	100
*****	1/4-28 X 3	SEMI-STD	SS237175	3/8-24 X 1 3/4	SEMI-STD
SS231025	5/16-24 X 1/4	100	*****	3/8-24 X 2	SEMI-STD
SS231031	5/16-24 X 5/16	100	*****	3/8-24 X 2 1/4	SEMI-STD

SEMI-STD PLUSIEURS QUANTITÉS DISPONIBLES / SEMI-STD PACKAGING ANY QUANTITY



Tel.: (819) 346-2903 / (888) 345-2903 Fax.: (819) 346-3389

Email: distributeur@boulonsestrie.com

B-51

VIS DE PRESSION  
À 6 PANS CREUX  
FILETS FINS

NOIR / BARE  
ALLOY STEEL

SOCKET SET SCREWS  
CUP POINT  
NATIONAL FINE

LA FINITION PLAQUÉE ZINC  
EST DISPONIBLE  
SUR DEMANDE



ZINC PLATED IS  
AVAILABLE ON REQUEST

NOTRE CODE	DESCRIPTION	QTÉ/BTE	NOTRE CODE	DESCRIPTION	QTÉ/BTE
OUR CODE	DESCRIPTION	QTY/BOX	OUR CODE	DESCRIPTION	QTY/BOX
*****	3/8-24 X 2 1/2	SEMI-STD	*****	1/2-20 X 4	SEMI-STD
*****	3/8-24 X 3	SEMI-STD	SS262050	5/8-11 X 1/2	SEMI-STD
SS243037	7/16-20 X 3/8	100	SS262062	5/8-18 X 5/8	50
*****	7/16-20 X 7/16	100	*****	5/8-18 X 3/4	SEMI-STD
SS243050	7/16-20 X 1/2	100	*****	5/8-18 X 7/8	SEMI-STD
*****	7/16-20 X 5/8	SEMI-STD	SS262100	5/8-18 X 1	50
SS243075	7/16-20 X 3/4	SEMI-STD	SS262125	5/8-18 X 1 1/4	SEMI-STD
*****	7/16-20 X 7/8	SEMI-STD	*****	5/8-18 X 1 1/2	SEMI-STD
SS243100	7/16-20 X 1	SEMI-STD	*****	5/8-18 X 1 3/4	SEMI-STD
*****	7/16-20 X 1 1/4	SEMI-STD	*****	5/8-18 X 2	SEMI-STD
SS243150	7/16-20 X 1 1/2	SEMI-STD	*****	5/8-18 X 2 1/2	SEMI-STD
*****	7/16-20 X 1 3/4	SEMI-STD	*****	5/8-18 X 3	SEMI-STD
*****	7/16-20 X 2	SEMI-STD	*****	5/8-18 X 4	SEMI-STD
*****	7/16-20 X 2 1/2	SEMI-STD	SS275075	3/4-16 X 3/4	SEMI-STD
*****	7/16-20 X 3	SEMI-STD	SS275100	3/4-16 X 1	SEMI-STD
*****	1/2-20 X 3/8	SEMI-STD	*****	3/4-16 X 1 1/4	SEMI-STD
SS250050	1/2-20 X 1/2	SEMI-STD	*****	3/4-16 X 1 1/2	SEMI-STD
SS250062	1/2-20 X 5/8	100	*****	3/4-16 X 1 3/4	SEMI-STD
SS250075	1/2-20 X 3/4	100	*****	3/4-16 X 2	SEMI-STD
*****	1/2-20 X 7/8	SEMI-STD	*****	3/4-16 X 2 1/4	SEMI-STD
SS250100	1/2-20 X 1	100	*****	3/4-16 X 2 1/2	SEMI-STD
*****	1/2-20 X 1 1/4	SEMI-STD	*****	3/4-16 X 3	SEMI-STD
*****	1/2-20 X 1 1/2	SEMI-STD	*****	3/4-16 X 4	SEMI-STD
*****	1/2-20 X 1 3/4	SEMI-STD	*****	7/8-14 X 1	SEMI-STD
*****	1/2-20 X 2	SEMI-STD	*****	7/8-14 X 1 1/4	SEMI-STD
*****	1/2-20 X 2 1/2	SEMI-STD	*****	7/8-14 X 1 1/2	SEMI-STD
*****	1/2-20 X 3	SEMI-STD	*****	7/8-14 X 2	SEMI-STD
*****	1/2-20 X 3 1/2	SEMI-STD	*****	7/8-14 X 2 1/2	SEMI-STD

SEMI-STD PLUSIEURS QUANTITÉS DISPONIBLES / SEMI-STD PACKAGING ANY QUANTITY



Tel.: (819) 346-2903 / (888) 345-2903 Fax.: (819) 346-3389

Email: distributeur@boulonstrie.com

B-52

VIS DE PRESSION  
 À 6 PANS CREUX  
 FILETS FINS

NOIR / BARE  
 ALLOY STEEL

SOCKET SET SCREWS  
 CUP POINT  
 NATIONAL FINE

LA FINITION PLAQUÉE ZINC  
 EST DISPONIBLE  
 SUR DEMANDE

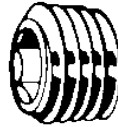

ZINC PLATED IS  
 AVAILABLE ON REQUEST

NOTRE CODE	DESCRIPTION	QTÉ/BTE	NOTRE CODE	DESCRIPTION	QTÉ/BTE
OUR CODE	DESCRIPTION	QTY/BOX	OUR CODE	DESCRIPTION	QTY/BOX
*****	7/8-14 X 3	SEMI-STD	*****	1-14 X 2 1/2	SEMI-STD
*****	1-14 X 1	SEMI-STD	*****	1-14 X 3	SEMI-STD
*****	1-14 X 1 1/2	SEMI-STD	*****	1-14 X 4	SEMI-STD
*****	1-14 X 2	SEMI-STD			

SEMI-STD PACKAGING ANY QUANTITY / SEMI-STD PLUSIEURS QUANTITÉS DISPONIBLES

**AUSSI DISPONIBLE**

**ALSO AVAILABLE**

**CONE PT**

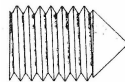

**OVAL PT**

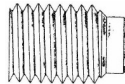

**HALF DOG PT**

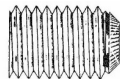

**KNURLED PT**

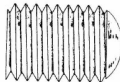

**FLAT PT**

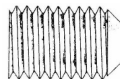

Tel.: (819) 346-2903 / (888) 345-2903 Fax.: (819) 346-3389  
 Email: distributeur@boulonsestrie.com

**B-53**

GROS FILETS  
& FILETS FINS



NATIONAL COARSE  
& NATIONAL FINE

NOTRE CODE	DESCRIPTION	QTÉ/BTE	NOTRE CODE	DESCRIPTION	QTÉ/BTE
OUR CODE	DESCRIPTION	QTY/BOX	OUR CODE	DESCRIPTION	QTY/BOX
SS402012	2-56 X 1/8	100	SS425062	1/4-20 X 5/8	100
SS402025	2-56 X 1/4	100	SS425075	1/4-20 X 3/4	100
SS404012	4-40 X 1/8	100	SS425087	1/4-20 X 7/8	100
SS404018	4-40 X 3/16	100	SS425100	1/4-20 X 1	100
SS404025	4-40 X 1/4	100	SS425200	1/4-20 X 2	100
SS406012	6-32 X 1/8	100	SS426025	1/4-28 X 1/4	100
SS406018	6-32 X 3/16	100	SS426031	1/4-28 X 5/16	100
SS406025	6-32 X 1/4	100	SS426037	1/4-28 X 3/8	100
SS406037	6-32 X 3/8	100	SS431025	5/16-18 X 1/4	100
SS408012	8-32 X 1/8	100	SS431031	5/16-18 X 5/16	100
SS408025	8-32 X 1/4	100	SS431037	5/16-18 X 3/8	100
SS408037	8-32 X 3/8	100	SS431050	5/16-18 X 1/2	100
SS408050	8-32 X 1/2	100	SS431062	5/16-18 X 5/8	100
SS408075	8-32 X 3/4	100	SS431075	5/16-18 X 3/4	100
SS410018	10-24 X 3/16	100	SS431100	5/16-18 X 1	100
SS410025	10-24 X 1/4	100	SS432037	5/16-24 X 3/8	100
SS410031	10-24 X 5/16	100	SS432050	5/16-24 X 1/2	100
SS410037	10-24 X 3/8	100	SS432125	5/16-24 X 1 1/4	100
SS410050	10-24 X 1/2	100	SS437037	3/8-16 X 3/8	100
SS410075	10-24 X 3/4	100	SS437050	3/8-16 X 1/2	100
SS411018	10-32 X 3/16	100	SS437075	3/8-16 X 3/4	100
SS411025	10-32 X 1/4	100	SS437087	3/8-16 X 7/8	100
SS411031	10-32 X 5/16	100	SS437100	3/8-16 X 1	100
SS411037	10-32 X 3/8	100	SS438025	3/8-24 X 1/4	100
SS411043	10-32 X 7/16	100	SS438037	3/8-24 X 3/8	100
SS411050	10-32 X 1/2	100	SS438225	3/8-24 X 2 1/4	100
SS425025	1/4-20 X 1/4	100	SS450037	1/2-13 X 3/8	50
SS425031	1/4-20 X 5/16	100	SS450050	1/2-13 X 1/2	50
SS425037	1/4-20 X 3/8	100	SS450062	1/2-13 X 5/8	50
SS425050	1/4-20 X 1/2	100	SS450075	1/2-13 X 3/4	50



VIS DE PRESSION  
À 6 PANS CREUX

SS-304 / 18-8

SOCKET SET SCREWS  
CUP POINT

GROS FILETS  
& FILETS FINS



NATIONAL COARSE  
& NATIONAL FINE

NOTRE CODE	DESCRIPTION	QTÉ/BTE	NOTRE CODE	DESCRIPTION	QTÉ/BTE
OUR CODE	DESCRIPTION	QTY/BOX	OUR CODE	DESCRIPTION	QTY/BOX
SS450100	1/2-13 X 1	50	SS462200	5/8-11 X 2	25
SS450150	1/2-13 X 1 1/2	50	SS475100	3/4-10 X 1	20
SS450175	1/2-13 X 1 3/4	50	SS475150	3/4-10 X 1 1/2	20
SS450200	1/2-13 X 2	50	SS487100	7/8-9 X 1	20
SS450250	1/2-13 X 1 1/2	50	SS487125	7/8-9 X 1 1/4	20
SS462075	5/8-11 X 3/4	25	SS487200	7/8-9 X 2	20
SS462100	5/8-11 X 1	25	SS490200	1-8 X 2	15
SS462150	5/8-11 X 1 1/2	25			

AUTRES DIMENSIONS DISPONIBLES/OTHER DIMENSIONS ARE AVAILABLE

**AUSSI DISPONIBLE**

**ALSO AVAILABLE**

**SS 316**



Tel.: (819) 346-2903 / (888) 345-2903 Fax.: (819) 346-3389

Email: [distributeur@boulonsestrie.com](mailto:distributeur@boulonsestrie.com)

**B-55**

MÉTRIQUE DIN 916 METRIC / CLASS 45H



NOTRE CODE	DESCRIPTION	QTÉ/BTE	NOTRE CODE	DESCRIPTION	QTÉ/BTE
OUR CODE	DESCRIPTION	QTY/BOX	OUR CODE	DESCRIPTION	QTY/BOX
*****	M1.6 X .35 X 2.5	100	ST004006	M4 X .70 X 6	100
*****	M1.6 X .35 X 3	100	*****	M4 X .70 X 8	100
*****	M1.6 X .35 X 4	100	ST040010	M4 X .70 X 10	100
*****	M1.6 X .35 X 5	100	ST040012	M4 X .70 X 12	100
*****	M2 X .40 X 2.5	100	ST004016	M4 X .70 X 16	100
*****	M2 X .40 X 3	100	ST040020	M4 X .70 X 20	100
*****	M2 X .40 X 4	100	ST004025	M4 X .70 X 25	100
*****	M2 X .40 X 5	100	ST005005	M5 X .80 X 5	100
ST002006	M2 X .40 X 6	100	ST005006	M5 X .80 X 6	100
*****	M2 X .40 X 8	100	ST005008	M5 X .80 X 8	100
ST002010	M2 X .40 X 10	100	ST005010	M5 X .80 X 10	100
*****	M2.5 X .45 X 3	100	ST005012	M5 X .80 X 12	100
*****	M2.5 X .45 X 4	100	ST005016	M5 X .80 X 16	100
ST002505	M2.5 X .45 X 5	100	ST005020	M5 X .80 X 20	100
ST002506	M2.5 X .45 X 6	100	ST005025	M5 X .80 X 25	100
*****	M2.5 X .45 X 8	100	ST005030	M5 X .80 X 30	100
*****	M2.5 X .45 X 10	100	ST005035	M5 X .80 X 35	100
ST003003	M3 X .50 X 3	100	*****	M5 X .80 X 40	100
ST003004	M3 X .50 X 4	100	ST005045	M5 X .80 X 45	100
ST003005	M3 X .50 X 5	100	*****	M5 X .80 X 50	100
*****	M3 X .50 X 6	100	ST006006	M6 X 1.00 X 6	100
SR003008	M3 X .50 X 8	100	ST006008	M6 X 1.00 X 8	100
ST003010	M3 X .50 X 10	100	ST006010	M6 X 1.00 X 10	100
ST003012	M3 X .50 X 12	100	ST006012	M6 X 1.00 X 12	100
*****	M3 X .50 X 16	100	ST006016	M6 X 1.00 X 16	100
ST003020	M3 X .50 X 20	100	ST006020	M6 X 1.00 X 20	100
ST003025	M3 X .50 X 25	100	ST006025	M6 X 1.00 X 25	100
ST004004	M4 X .70 X 4	100	*****	M6 X 1.00 X 30	100
ST004005	M4 X .70 X 5	100	ST006035	M6 X 1.00 X 35	100



MÉTRIQUE DIN 913 / METRIC DIN 913



NOTRE CODE	DESCRIPTION	QTÉ/BTE	NOTRE CODE	DESCRIPTION	QTÉ/BTE
OUR CODE	DESCRIPTION	QTY/BOX	OUR CODE	DESCRIPTION	QTY/BOX
ST006040	M6 X 1.00 X 40	100	ST012016	M12 X 1.75 X 16	100
ST006045	M6 X 1.00 X 45	100	ST012020	M12 X 1.75 X 20	100
ST006050	M6 X 1.00 X 50	100	ST012025	M12 X 1.75 X 25	100
ST008008	M8 X 1.25 X 8	100	ST012030	M12 X 1.75 X 30	100
ST008010	M8 X 1.25 X 10	100	ST012035	M12 X 1.75 X 35	100
ST008012	M8 X 1.25 X 12	100	ST012040	M12 X 1.75 X 40	50
ST008016	M8 X 1.25 X 16	100	ST012045	M12 X 1.75 X 45	50
ST008018	M8 X 1.25 X 18	100	ST012050	M12 X 1.75 X 50	50
ST008020	M8 X 1.25 X 20	100	*****	M12 X 1.75 X 55	50
ST008025	M8 X 1.25 X 25	100	ST012060	M12 X 1.75 X 60	50
ST008030	M8 X 1.25 X 30	100	*****	M12 X 1.75 X 70	50
ST008035	M8 X 1.25 X 35	100	*****	M12 X 1.75 X 80	50
ST008040	M8 X 1.25 X 40	100	ST012100	M12 X 1.75 X 100	50
ST008045	M8 X 1.25 X 45	100	ST016016	M16 X 2.00 X 16	50
ST008050	M8 X 1.25 X 50	100	*****	M16 X 2.00 X 20	50
ST010008	M10 X 1.50 X 8	100	*****	M16 X 2.00 X 25	50
ST010010	M10 X 1.50 X 10	100	*****	M16 X 2.00 X 30	50
*****	M10 X 1.50 X 12	100	*****	M16 X 2.00 X 35	50
ST010016	M10 X 1.50 X 16	100	ST016040	M16 X 2.00 X 40	50
ST010020	M10 X 1.50 X 20	100	*****	M16 X 2.00 X 45	50
ST010025	M10 X 1.50 X 25	100	ST016050	M16 X 2.00 X 50	50
ST010030	M10 X 1.50 X 30	100	*****	M16 X 2.00 X 55	50
ST010035	M10 X 1.50 X 35	100	*****	M16 X 2.00 X 60	50
ST010040	M10 X 1.50 X 40	100	ST020020	M20 X 2.50 X 20	50
*****	M10 X 1.50 X 45	50	*****	M20 X 2.50 X 25	50
*****	M10 X 1.50 X 50	50	*****	M20 X 2.50 X 30	50
*****	M10 X 1.50 X 55	50	*****	M20 X 2.50 X 35	50
ST010060	M10 X 1.50 X 60	50	*****	M20 X 2.50 X 40	50
ST012012	M12 X 1.75 X 12	100	*****	M20 X 2.50 X 45	50



MÉTRIQUE DIN 913 / METRIC DIN 913

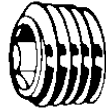

NOTRE CODE	DESCRIPTION	QTÉ/BTE	NOTRE CODE	DESCRIPTION	QTÉ/BTE
OUR CODE	DESCRIPTION	QTY/BOX	OUR CODE	DESCRIPTION	QTY/BOX
*****	M20 X 2.50 X 50	25	*****	M24 X 3.00 X 40	25
*****	M20 X 2.50 X 55	25	*****	M24 X 3.00 X 45	25
*****	M20 X 2.50 X 60	25	*****	M24 X 3.00 X 50	25
*****	M20 X 2.50 X 70	25	*****	M24 X 3.00 X 55	25
*****	M20X 2.50 X 80	25	*****	M24 X 3.00 X 60	25
ST024025	M24 X 3.00 X 25	25	*****	M24 X 3.00 X 70	25
*****	M24 X 3.00 X 30	25	*****	M24 X 3.00 X 80	25
*****	M24 X 3.00 X 35	25			

**AUSSI DISPONIBLE /**

**ALSO AVAILABLE**

**SS304 (A2) & SS316 (A4)**



Tel.: (819) 346-2903 / (888) 345-2903 Fax.: (819) 346-3389

Email: [distributeur@boulonsestrie.com](mailto:distributeur@boulonsestrie.com)



VIS À TÊTE RONDE  
À 6 PANS CREUX  
GROS FILETS

NOIR / BARE

BUTTON HEAD SOCKET  
CAP SCREWS  
NATIONAL COARSE

LA FINITION PLAQUÉE ZINC  
EST DISPONIBLE  
SUR DEMANDE

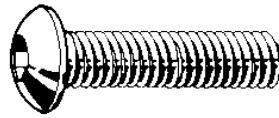

ZINC PLATED IS  
AVAILABLE ON REQUEST

NOTRE CODE	DESCRIPTION	QTÉ/BTE	NOTRE CODE	DESCRIPTION	QTÉ/BTE
OUR CODE	DESCRIPTION	QTY/BOX	OUR CODE	DESCRIPTION	QTY/BOX
***** SB102001	2-56 X 1/8	SEMI-STD 100	SB105003	5-40 X 1/4	SEMI-STD
SB102002	2-56 X 3/16	100	SB105004	5-40 X 3/8	SEMI-STD
***** SB102004	2-56 X 1/4	100	SB105005	5-40 X 1/2	SEMI-STD
*****	2-56 X 5/16	SEMI-STD	*****	5-40 X 5/8	SEMI-STD
*****	2-56 X 3/8	100	SB105007	5-40 X 3/4	SEMI-STD
*****	2-56 X 1/2	100	*****	5-40 X 1	SEMI-STD
*****	2-56 X 5/8	SEMI-STD	*****	5-40 X 1 1/4	SEMI-STD
*****	2-56 X 3/4	SEMI-STD	*****	5-40 X 1 1/2	SEMI-STD
*****	2-56 X 1	SEMI-STD	*****	6-32 X 3/16	SEMI-STD
*****	3-48 X 3/16	100	SB106002	6-32 X 1/4	100
*****	3-48 X 1/4	100	*****	6-32 X 5/16	SEMI-STD
*****	3-48 X 5/16	SEMI-STD	SB106004	6-32 X 3/8	100
*****	3-48 X 3/8	100	*****	6-32 X 7/16	SEMI-STD
*****	3-48 X 1/2	100	SB106005	6-32 X 1/2	100
*****	3-48 X 5/8	SEMI-STD	SB106006	6-32 X 5/8	100
*****	3-48 X 3/4	SEMI-STD	SB106007	6-32 X 3/4	SEMI-STD
*****	3-48 X 7/8	SEMI-STD	*****	6-32 X 7/8	SEMI-STD
*****	3-48 X 1	SEMI-STD	SB106010	6-32 X 1	SEMI-STD
*****	4-40 X 3/16	SEMI-STD	*****	6-32 X 1 1/4	SEMI-STD
SB104002	4-40 X 1/4	100	SB106015	6-32 X 1 1/2	SEMI-STD
SB104003	4-40 X 5/16	SEMI-STD	*****	6-32 X 2	SEMI-STD
SB104004	4-40 X 3/8	100	*****	6-32 X 2 1/2	SEMI-STD
*****	4-40 X 7/16	SEMI-STD	*****	6-32 X 3	SEMI-STD
SB104005	4-40 X 1/2	100	*****	8-32 X 3/16	SEMI-STD
*****	4-40 X 5/8	SEMI-STD	SB108002	8-32 X 1/4	100
*****	4-40 X 3/4	SEMI-STD	*****	8-32 X 5/16	SEMI-STD
*****	4-40 X 7/8	SEMI-STD	SB108004	8-32 X 3/8	100
SB104010	4-40 X 1	SEMI-STD	*****	8-32 X 7/16	SEMI-STD

SEMI-STD PLUSIEURS QUANTITÉS DISPONIBLES / SEMI-STD PACKAGING ANY QUANTITY



Tel.: (819) 346-2903 / (888) 345-2903 Fax.: (819) 346-3389

Email: distributeur@boulonsestrie.com

B-59

VIS À TÊTE RONDE  
À 6 PANS CREUX  
GROS FILETS

NOIR / BARE

BUTTON HEAD SOCKET  
CAP SCREWS  
NATIONAL COARSE

LA FINITION PLAQUÉE ZINC  
EST DISPONIBLE  
SUR DEMANDE

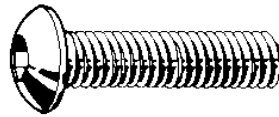

ZINC PLATED IS  
AVAILABLE ON REQUEST

NOTRE CODE	DESCRIPTION	QTÉ/BTE	NOTRE CODE	DESCRIPTION	QTÉ/BTE
OUR CODE	DESCRIPTION	QTY/BOX	OUR CODE	DESCRIPTION	QTY/BOX
SB108005	8-32 X 1/2	100	SB125006	1/4-20 X 5/8	100
SB108006	8-32 X 5/8	100	SB125007	1/4-20 X 3/4	100
SB108007	8-32 X 3/4	100	SB125008	1/4-20 X 7/8	100
*****	8-32 X 7/8	SEMI-STD	SB125010	1/4-20 X 1	100
SB108010	8-32 X 1	SEMI-STD	SB125012	1/4-20 X 1 1/4	SEMI-STD
*****	8-32 X 1 1/4	SEMI-STD	SB125015	1/4-20 X 1 1/2	SEMI-STD
SB108015	8-32 X 1 1/2	SEMI-STD	SB125017	1/4-20 X 1 3/4	SEMI-STD
*****	8-32 X 1 3/4	SEMI-STD	SB125020	1/4-20 X 2	SEMI-STD
*****	8-32 X 2	SEMI-STD	SB125025	1/4-20 X 2 1/2	SEMI-STD
SB110002	10-24 X 1/4	100	*****	1/4-20 X 3	SEMI-STD
*****	10-24 X 5/16	SEMI-STD	*****	1/4-20 X 3 1/4	SEMI-STD
SB110004	10-24 X 3/8	100	*****	1/4-20 X 3 1/2	SEMI-STD
*****	10-24 X 7/16	SEMI-STD	SB131004	5/16-18 X 3/8	100
SB110005	10-24 X 1/2	100	SB131005	5/16-18 X 1/2	100
SB110006	10-24 X 5/8	100	SB131006	5/16-18 X 5/8	100
SB110007	10-24 X 3/4	100	SB131007	5/16-18 X 3/4	100
*****	10-24 X 7/8	100	SB131008	5/16-18 X 7/8	100
SB110010	10-24 X 1	100	SB131010	5/16-18 X 1	100
SB110012	10-24 X 1 1/4	SEMI-STD	SB131012	5/16-18 X 1 1/4	SEMI-STD
SB110015	10-24 X 1 1/2	SEMI-STD	SB131015	5/16-18 X 1 1/2	SEMI-STD
SB110017	10-24 X 1 3/4	SEMI-STD	SB131017	5/16-18 X 1 3/4	SEMI-STD
SB110020	10-24 X 2	SEMI-STD	SB131020	5/16-18 X 2	SEMI-STD
*****	10-24 X 2 1/4	SEMI-STD	*****	5/16-18 X 2 1/4	SEMI-STD
*****	10-24 X 2 1/2	SEMI-STD	SB131025	5/16-18 X 2 1/2	SEMI-STD
SB125002	1/4-20 X 1/4	SEMI-STD	SB131030	5/16-18 X 3	SEMI-STD
*****	1/4-20 X 5/16	SEMI-STD	*****	5/16-18 X 3 1/2	SEMI-STD
SB125004	1/4-20 X 3/8	100	*****	5/16-18 X 4	SEMI-STD
SB125005	1/4-20 X 1/2	100	SB137005	3/8-16 X 1/2	100

SEMI-STD PLUSIEURS QUANTITÉS DISPONIBLES / SEMI-STD PACKAGING ANY QUANTITY



Tel.: (819) 346-2903 / (888) 345-2903 Fax.: (819) 346-3389

Email: distributeur@boulonsestrie.com

B-60

VIS À TÊTE RONDE  
 À 6 PANS CREUX  
 GROS FILETS

NOIR / BARE

BUTTON HEAD SOCKET  
 CAP SCREWS  
 NATIONAL COARSE

LA FINITION PLAQUÉE ZINC  
 EST DISPONIBLE  
 SUR DEMANDE

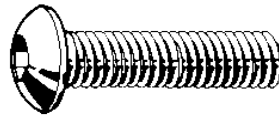

ZINC PLATED IS  
 AVAILABLE ON REQUEST

NOTRE CODE	DESCRIPTION	QTÉ/BTE	NOTRE CODE	DESCRIPTION	QTÉ/BTE
OUR CODE	DESCRIPTION	QTY/BOX	OUR CODE	DESCRIPTION	QTY/BOX
*****	3/8-16 X 5/8	100	SB150012	1/2-13 X 1 1/4	100
SB137007	3/8-16 X 3/4	100	SB150015	1/2-13 X 1 1/2	100
SB137008	3/8-16 X 7/8	100	*****	1/2-13 X 1 3/4	SEMI-STD
SB137010	3/8-16 X 1	100	SB150020	1/2-13 X 2	100
SB137012	3/8-16 X 1 1/4	100	*****	1/2-13 X 2 1/4	SEMI-STD
SB137015	3/8-16 X 1 1/2	SEMI-STD	*****	1/2-13 X 2 1/2	SEMI-STD
SB137017	3/8-16 X 1 3/4	SEMI-STD	*****	1/2-13 X 3	SEMI-STD
SB137020	3/8-16 X 2	SEMI-STD	*****	1/2-13 X 3 1/2	SEMI-STD
SB137022	3/8-16 X 2 1/4	SEMI-STD	*****	1/2-13 X 4	SEMI-STD
SB137025	3/8-16 X 2 1/2	SEMI-STD	*****	5/8-11 X 1	50
SB137027	3/8-16 X 2 3/4	SEMI-STD	*****	5/8-11 X 1 1/4	50
SB137030	3/8-16 X 3	SEMI-STD	*****	5/8-11 X 1 1/2	50
*****	3/8-16 X 3 1/2	SEMI-STD	*****	5/8-11 X 1 3/4	SEMI-STD
*****	3/8-16 X 4	SEMI-STD	SB162020	5/8-11 X 2	50
*****	3/8-16 X 4 1/2	SEMI-STD	*****	5/8-11 X 2 1/4	SEMI-STD
SB150007	1/2-13 X 3/4	SEMI-STD	*****	5/8-11 X 2 1/2	SEMI-STD
*****	1/2-13 X 7/8	SEMI-STD	*****	5/8-11 X 3	SEMI-STD
SB150010	1/2-13 X 1	100			

SEMI-STD PLUSIEURS QUANTITÉS DISPONIBLES / SEMI-STD PACKAGING ANY QUANTITY



Tel.: (819) 346-2903 / (888) 345-2903 Fax.: (819) 346-3389

Email: distributeur@boulonsestrie.com

B-61

VIS À TÊTE RONDE  
À 6 PANS CREUX  
FILETS FINS

NOIR / BARE

BUTTON HEAD SOCKET  
CAP SCREWS  
NATIONAL FINE

LA FINITION PLAQUÉE ZINC  
EST DISPONIBLE  
SUR DEMANDE

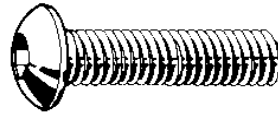

ZINC PLATED IS  
AVAILABLE ON REQUEST

NOTRE CODE	DESCRIPTION	QTÉ/BTE	NOTRE CODE	DESCRIPTION	QTÉ/BTE
OUR CODE	DESCRIPTION	QTY/BOX	OUR CODE	DESCRIPTION	QTY/BOX
*****	0-80 X 1/8	100	SB111004	10-32 X 3/8	100
*****	0-80 X 3/16	100	*****	10-32 X 7/16	SEMI-STD
*****	0-80 X 1/4	100	SB111005	10-32 X 1/2	100
*****	0-80 X 3/8	100	SB111006	10-32 X 5/8	100
*****	0-80 X 1/2	SEMI-STD	SB111007	10-32 X 3/4	100
*****	0-80 X 5/8	SEMI-STD	*****	10-32 X 7/8	100
*****	0-80 X 3/4	SEMI-STD	SB111010	10-32 X 1	100
*****	0-80 X 1	SEMI-STD	SB111012	10-32 X 1 1/4	SEMI-STD
*****	1-72 X 1/8	100	SB111015	10-32 X 1 1/2	SEMI-STD
*****	1-72 X 3/16	100	SB111017	10-32 X 1 3/4	SEMI-STD
*****	1-72 X 1/4	100	SB110020	10-32 X 2	SEMI-STD
*****	1-72 X 5/16	SEMI-STD	*****	10-32 X 2 1/4	SEMI-STD
*****	1-72 X 3/8	100	*****	10-32 X 2 1/2	SEMI-STD
*****	1-72 X 1/2	SEMI-STD	*****	10-32 X 3	SEMI-STD
*****	1-72 X 5/8	SEMI-STD	SB126004	1/4-28 X 3/8	100
*****	1-72 X 3/4	SEMI-STD	SB126005	1/4-28 X 1/2	100
*****	1-72 X 1	SEMI-STD	*****	1/4-28 X 5/8	100
*****	6-40 X 1/4	SEMI-STD	SB126007	1/4-28 X 3/4	100
*****	6-40 X 3/8	SEMI-STD	*****	1/4-28 X 7/8	SEMI-STD
*****	6-40 X 1/2	SEMI-STD	SB126010	1/4-28 X 1	100
*****	8-36 X 1/4	SEMI-STD	SB126012	1/4-28 X 1 1/4	SEMI-STD
*****	8-36 X 3/8	SEMI-STD	SB126015	1/4-28 X 1 1/2	SEMI-STD
*****	8-36 X 1/2	SEMI-STD	SB126017	1/4-28 X 1 3/4	SEMI-STD
*****	8-36 X 5/8	SEMI-STD	SB126020	1/4-28 X 2	SEMI-STD
*****	8-36 X 3/4	SEMI-STD	*****	5/16-24 X 3/8	100
*****	8-36 X 1	SEMI-STD	*****	5/16-24 X 1/2	100
SB111002	10-32 X 1/4	100	*****	5/16-24 X 5/8	100
SB111003	10-32 X 5/16	SEMI-STD	*****	5/16-24 X 3/4	100

SEMI-STD PLUSIEURS QUANTITÉS DISPONIBLES / SEMI-STD PACKAGING ANY QUANTITY



Tel.: (819) 346-2903 / (888) 345-2903 Fax.: (819) 346-3389

Email: distributeur@boulonstrie.com

B-62

VIS À TÊTE RONDE  
 À 6 PANS CREUX  
 FILETS FINS

NOIR / BARE

BUTTON HEAD SOCKET  
 CAP SCREWS  
 NATIONAL FINE

LA FINITION PLAQUÉE ZINC  
 EST DISPONIBLE  
 SUR DEMANDE

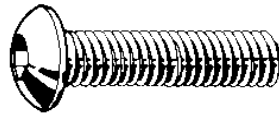

ZINC PLATED IS  
 AVAILABLE ON REQUEST

NOTRE CODE	DESCRIPTION	QTÉ/BTE	NOTRE CODE	DESCRIPTION	QTÉ/BTE
OUR CODE	DESCRIPTION	QTY/BOX	OUR CODE	DESCRIPTION	QTY/BOX
*****	5/16-24 X 7/8	SEMI-STD	*****	3/8-24 X 1 3/4	SEMI-STD
*****	5/16-24 X 1	100	*****	3/8-24 X 2	SEMI-STD
*****	5/16-24 X 1 1/4	SEMI-STD	*****	3/8-24 X 2 1/4	SEMI-STD
*****	5/16-24 X 1 1/2	SEMI-STD	*****	3/8-24 X 2 1/2	SEMI-STD
*****	5/16-24 X 1 3/4	SEMI-STD	*****	3/8-24 X 3	SEMI-STD
*****	5/16-24 X 2	SEMI-STD	*****	1/2-20 X 1	SEMI-STD
*****	3/8-24 X 1/2	100	*****	1/2-20 X 1 1/4	SEMI-STD
*****	3/8-24 X 5/8	100	*****	1/2-20 X 1 1/2	SEMI-STD
SB138007	3/8-24 X 3/4	100	*****	1/2-20 X 2	SEMI-STD
*****	3/8-24 X 7/8	SEMI-STD	*****	1/2-20 X 2 1/2	SEMI-STD
*****	3/8-24 X 1	SEMI-STD	*****	1/2-20 X 3	SEMI-STD
SB138012	3/8-24 X 1 1/4	SEMI-STD	*****	1/2-20 X 4	SEMI-STD
*****	3/8-24 X 1 1/2	SEMI-STD			

SEMI-STD PLUSIEURS QUANTITÉS DISPONIBLES / SEMI-STD PACKAGING ANY QUANTITY



Tel.: (819) 346-2903 / (888) 345-2903 Fax.: (819) 346-3389

Email: distributeur@boulonstrie.com

B-63

VIS À TÊTE RONDE  
 À 6 PANS CREUX  
 GROS FILETS

SS-304  
 18-8

BUTTON HEAD SOCKET  
 CAP SCREWS  
 NATIONAL COARSE

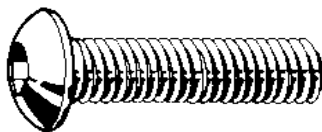

NOTRE CODE	DESCRIPTION	QTÉ/BTE
OUR CODE	DESCRIPTION	QTY/BOX
SB206001	6-32 X 3/16	100
SB206002	6-32 X 1/4	100
SB206004	6-32 X 3/8	100
SB206005	6-32 X 1/2	100
SB206006	6-32 X 5/8	100
SB206007	6-32 X 3/4	100
SB208004	8-32 X 3/8	100
SB208005	8-32 X 1/2	100
SB208006	8-32 X 5/8	100
SB208007	8-32 X 3/4	100
SB208020	8-32 X 2	100
SB210002	10-24 X 1/4	100
SB210004	10-24 X 3/8	100
SB210005	10-24 X 1/2	100
SB210007	10-24 X 3/4	100
SB210015	10-24 X 1 1/2	100
SB211002	10-32 X 1/4	100
SB211004	10-32 X 3/8	100
SB211005	10-32 X 1/2	100
SB211006	10-32 X 5/8	100
SB211007	10-32 X 3/4	100
SB211010	10-32 X 1	100
SB225003	1/4-20 X 3/8	100
SB225005	1/4-20 X 1/2	100
SB225006	1/4-20 X 5/8	100
SB225007	1/4-20 X 3/4	100
SB225008	1/4-20 X 7/8	100
SB225010	1/4-20 X 1	100

AUTRES DIMENSIONS DISPONIBLES / OTHER DIMENSION ARE AVAILABLE



Tel.: (819) 346-2903 / (888) 345-2903 Fax.: (819) 346-3389  
 Email: distributeur@boulonsestrie.com

VIS À TÊTE RONDE  
À 6 PANS CREUX  
GROS FILETS

SS-304  
18-8

BUTTON HEAD SOCKET  
CAP SCREWS  
NATIONAL COARSE

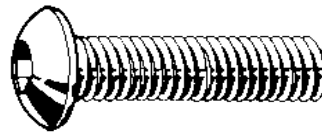

NOTRE CODE	DESCRIPTION	QTÉ/BTE
OUR CODE	DESCRIPTION	QTY/BOX
SB225012	1/4-20 X 1 1/4	100
SB225015	1/4-20 X 1 1/2	100
SB225017	1/4-20 X 1 3/4	100
SB225022	1/4-20 X 2 1/4	100
SB231004	5/16-18 X 3/8	100
SB231005	5/16-18 X 1/2	100
SB231006	5/16-18 X 5/8	100
SB231007	5/16-18 X 3/4	100
SB231010	5/16-18 X 1	100
SB231015	5/16-18 X 1 1/2	100
SB237006	3/8-16 X 5/8	100
SB237007	3/8-16 X 3/4	100
SB237010	3/8-16 X 1	100
SB237012	3/8-16 X 1 1/4	100
SB237020	3/8-16 X 2	100

AUTRES DIMENSIONS DISPONIBLES / OTHER DIMENSION ARE AVAILABLE



Tel.: (819) 346-2903 / (888) 345-2903 Fax.: (819) 346-3389  
Email: distributeur@boulonsestrie.com

B-65

VIS À TÊTE RONDE  
À 6 PANS CREUX  
GROS FILETS

NOIR / BARE  
GRADE 12.9

BUTTON HEAD SOCKET  
CAP SCREWS  
NATIONAL COARSE

MÉTRIQUE DIN 7380 METRIC

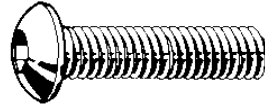

NOTRE CODE	DESCRIPTION	QTÉ/BTE	NOTRE CODE	DESCRIPTION	QTÉ/BTE
OUR CODE	DESCRIPTION	QTY/BOX	OUR CODE	DESCRIPTION	QTY/BOX
SBM03006	M3 X .50 X 6	100	SBM06025	M6 X 1.00 X 25	100
SBM03008	M3 X .50 X 8	100	SBM06030	M6 X 1.00 X 30	100
SBM03010	M3 X .50 X 10	100	SBM06035	M6 X 1.00 X 35	100
SBM03012	M3 X .50 X 12	100	SBM06040	M6 X 1.00 X 40	100
SBM03016	M3 X .50 X 16	100	SBM08010	M8 X 1.25 X 10	50
SBM03020	M3 X .50 X 20	100	SBM08012	M8 X 1.25 X 12	50
SBM03025	M3 X .50 X 25	100	*****	M8 X 1.25 X 14	50
SBM04006	M4 X .70 X 6	100	SBM08016	M8 X 1.25 X 16	50
SBM04008	M4 X .70 X 8	100	SBM08020	M8 X 1.25 X 20	50
SBM04010	M4 X .70 X 10	100	SBM08025	M8 X 1.25 X 25	50
SBM04012	M4 X .70 X 12	100	SBM08030	M8 X 1.25 X 30	50
SBM04020	M4 X .70 X 20	100	SBM08035	M8 X 1.25 X 35	50
SBM04025	M4 X .70 X 25	100	SBM08040	M8 X 1.25 X 40	50
SBM04030	M4 X .70 X 30	100	SBM08050	M8 X 1.25 X 50	50
SBM05006	M5 X .80 X 6	100	SBM10012	M10 X 1.50 X 12	25
SBM05008	M5 X .80 X 8	100	*****	M10 X 1.50 X 16	25
SBM05010	M5 X .80 X 10	100	SBM10020	M10 X 1.50 X 20	25
SBM05012	M5 X .80 X 12	100	SBM10025	M10 X 1.50 X 25	25
SBM05016	M5 X .80 X 16	100	*****	M10 X 1.50 X 30	25
SBM05020	M5 X .80 X 20	100	SBM10035	M10 X 1.50 X 35	25
SBM05025	M5 X .80 X 25	100	*****	M10 X 1.50 X 40	25
SBM05030	M5 X .80 X 30	100	*****	M12 X 1.75 X 16	25
SBM05035	M5 X .80 X 35	100	*****	M12 X 1.75 X 20	25
SBM05050	M5 X .80 X 50	100	SBM12025	M12 X 1.75 X 25	25
SBM06006	M6 X 1.00 X 6	100	*****	M12 X 1.75 X 30	25
SBM06010	M6 X 1.00 X 10	100	*****	M12 X 1.75 X 35	25
SBM06012	M6 X 1.00 X 12	100	SBM12040	M12 X 1.75 X 40	25
SBM06016	M6 X 1.00 X 16	100	*****	M12 X 1.75 X 45	25
SBM06020	M6 X 1.00 X 20	100	*****	M12 X 1.75 X 50	25

AUTRES DIMENSION DISPONIBLE / OTHER DIMENSION ARE AVAILABLE



Tel.: (819) 346-2903 / (888) 345-2903 Fax.: (819) 346-3389

Email: distributeur@boulonstrie.com

B-66



VIS A ÉPAULEMENT À  
TÊTE CREUSE 6 PANS

NOIR / BARE  
ALLOY STEEL

SOCKET SHOULDER  
SCREWS

LA FINITION PLAQUÉE ZINC  
EST DISPONIBLE  
SUR DEMANDE



ZINC PLATED IS  
AVAILABLE ON REQUEST

NOTRE CODE	DESCRIPTION	FILET	QTÉ/BTE
OUR CODE	DESCRIPTION	THREAD	QTY/BOX
SO025002	1/4 X 1/4	10-24	SEMI-STD
*****	1/4 X 5/16	10-24	SEMI-STD
SO025004	1/4 X 3/8	10-24	25
*****	1/4 X 7/16	10-24	SEMI-STD
SO025005	1/4 X 1/2	10-24	25
SO025006	1/4 X 5/8	10-24	25
S0025007	1/4 X 3/4	10-24	25
*****	1/4 X 7/8	10-24	SEMI-STD
SO025010	1/4 X 1	10-24	25
SO025012	1/4 X 1 1/4	10-24	25
S0025015	1/4 X 1 1/2	10-24	25
SO025017	1/4 X 1 3/4	10-24	SEMI-STD
SO025020	1/4 X 2	10-24	SEMI-STD
SO025022	1/4 X 2 1/4	10-24	SEMI-STD
SO025025	1/4 X 2 1/2	10-24	SEMI-STD
*****	1/4 X 2 3/4	10-24	SEMI-STD
SO025030	1/4 X 3	10-24	SEMI-STD
*****	1/4 X 3 1/4	10-24	SEMI-STD
*****	1/4 X 3 1/2	10-24	SEMI-STD
*****	1/4 X 4	10-24	SEMI-STD
SO031002	5/16 X 1/4	1/4-20	SEMI-STD
*****	5/16 X 5/16	1/4-20	SEMI-STD
S0031004	5/16 X 3/8	1/4-20	25
SO031005	5/16 X 1/2	1/4-20	25
SO031006	5/16 X 5/8	1/4-20	25
SO031007	5/16 X 3/4	1/4-20	25
SO031008	5/16 X 7/8	1/4-20	SEMI-STD
SO031010	5/16 X 1	1/4-20	25
SO031012	5/16 X 1 1/4	1/4-20	25



Tel.: (819) 346-2903 / (888) 345-2903 Fax.: (819) 346-3389

Email: distributeur@boulonstrie.com

B-67

VIS A ÉPAULEMENT À  
TÊTE CREUSE 6 PANS

NOIR / BARE  
ALLOY STEEL

SOCKET SHOULDER  
SCREWS

LA FINITION PLAQUÉE ZINC  
EST DISPONIBLE  
SUR DEMANDE



ZINC PLATED IS  
AVAILABLE ON REQUEST

NOTRE CODE	DESCRIPTION	FILET	QTÉ/BTE
OUR CODE	DESCRIPTION	THREAD	QTY/BOX
SO031015	5/16 X 1 1/2	1/4-20	25
SO031017	5/16 X 1 3/4	1/4-20	25
SO031020	5/16 X 2	1/4-20	25
SO031022	5/16 X 2 1/4	1/4-20	SEMI-STD
SO031025	5/16 X 2 1/2	1/4-20	SEMI-STD
SO031027	5/16 X 2 3/4	1/4-20	SEMI-STD
SO031030	5/16 X 3	1/4-20	SEMI-STD
*****	5/16 X 3 1/4	1/4-20	SEMI-STD
*****	5/16 X 3 1/2	1/4-20	SEMI-STD
*****	5/16 X 3 3/4	1/4-20	SEMI-STD
*****	5/16 X 4	1/4-20	SEMI-STD
SO037002	3/8 X 1/4	5/16-18	SEMI-STD
*****	3/8 X 5/16	5/16-18	SEMI-STD
SO037004	3/8 X 3/8	5/16-18	25
SO037005	3/8 X 1/2	5/16-18	25
SO037006	3/8 X 5/8	5/16-18	25
SO037007	3/8 X 3/4	5/16-18	25
SO037008	3/8 X 7/8	5/16-18	SEMI-STD
SO037010	3/8 X 1	5/16-18	25
SO037012	3/8 X 1 1/4	5/16-18	25
SO037015	3/8 X 1 1/2	5/16-18	25
SO037017	3/8 X 1 3/4	5/16-18	25
SO037020	3/8 X 2	5/16-18	25
SO037022	3/8 X 2 1/4	5/16-18	25
SO037025	3/8 X 2 1/2	5/16-18	25
SO037027	3/8 X 2 3/4	5/16-18	25
SO037030	3/8 X 3	5/16-18	25
SO037032	3/8 X 3 1/4	5/16-18	25
SO037035	3/8 X 3 1/2	5/16-18	25



Tel.: (819) 346-2903 / (888) 345-2903 Fax.: (819) 346-3389

Email: distributeur@boulonstrie.com

B-68

VIS A ÉPAULEMENT À  
TÊTE CREUSE 6 PANS

NOIR / BARE  
ALLOY STEEL

SOCKET SHOULDER  
SCREWS

LA FINITION PLAQUÉE ZINC  
EST DISPONIBLE  
SUR DEMANDE



ZINC PLATED IS  
AVAILABLE ON REQUEST

NOTRE CODE	DESCRIPTION	FILET	QTÉ/BTE
OUR CODE	DESCRIPTION	THREAD	QTY/BOX
SO037037	3/8 X 3 3/4	5/16-18	25
SO037040	3/8 X 4	5/16-18	25
SO037045	3/8 X 4 1/2	5/16-18	SEMI-STD
*****	3/8 X 5	5/16-18	SEMI-STD
*****	3/8 X 5 1/2	5/16-18	SEMI-STD
SO037060	3/8 X 6	5/16-18	SEMI-STD
SO050004	1/2 X 3/8	3/8-16	SEMI-STD
SO050005	1/2 X 1/2	3/8-16	25
SO050006	1/2 X 5/8	3/8-16	25
SO050007	1/2 X 3/4	3/8-16	25
SO050008	1/2 X 7/8	3/8-16	SEMI-STD
SO050010	1/2 X 1	3/8-16	25
SO050012	1/2 X 1 1/4	3/8-16	25
SO050015	1/2 X 1 1/2	3/8-16	25
*****	1/2 X 1 5/8	3/8-16	SEMI-STD
SO050017	1/2 X 1 3/4	3/8-16	25
SO050020	1/2 X 2	3/8-16	25
SO050022	1/2 X 2 1/4	3/8-16	SEMI-STD
SO050025	1/2 X 2 1/2	3/8-16	25
SO050027	1/2 X 2 3/4	3/8-16	25
SO050030	1/2 X 3	3/8-16	25
SO050032	1/2 X 3 1/4	3/8-16	25
SO050035	1/2 X 3 1/2	3/8-16	25
SO050037	1/2 X 3 3/4	3/8-16	25
SO050040	1/2 X 4	3/8-16	25
*****	1/2 X 4 1/4	3/8-16	25
SO050045	1/2 X 4 1/2	3/8-16	25
*****	1/2 X 4 3/4	3/8-16	25
SO050050	1/2 X 5	3/8-16	25



Tel.: (819) 346-2903 / (888) 345-2903 Fax.: (819) 346-3389

Email: distributeur@boulonstrie.com

B-69

VIS A ÉPAULEMENT À  
TÊTE CREUSE 6 PANS

NOIR / BARE  
ALLOY STEEL

SOCKET SHOULDER  
SCREWS

LA FINITION PLAQUÉE ZINC  
EST DISPONIBLE  
SUR DEMANDE

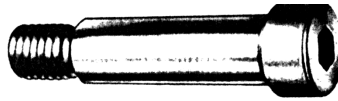

ZINC PLATED IS  
AVAILABLE ON REQUEST

NOTRE CODE	DESCRIPTION	FILET	QTÉ/BTE
OUR CODE	DESCRIPTION	THREAD	QTY/BOX
*****	1/2 X 5 1/2	3/8-16	SEMI-STD
SO050060	1/2 X 6	3/8-16	SEMI-STD
*****	1/2 X 6 1/2	3/8-16	SEMI-STD
SO050070	1/2 X 7	3/8-16	SEMI-STD
*****	1/2 X 8	3/8-16	SEMI-STD
SO062005	5/8 X 1/2	1/2-13	SEMI-STD
*****	5/8 X 5/8	1/2-13	SEMI-STD
SO062007	5/8 X 3/4	1/2-13	SEMI-STD
*****	5/8 X 7/8	1/2-13	SEMI-STD
SO062010	5/8 X 1	1/2-13	SEMI-STD
SO062012	5/8 X 1 1/4	1/2-13	25
SO062015	5/8 X 1 1/2	1/2-13	25
SO062017	5/8 X 1 3/4	1/2-13	25
SO062020	5/8 X 2	1/2-13	25
SO062022	5/8 X 2 1/4	1/2-13	25
SO062025	5/8 X 2 1/2	1/2-13	25
SO062027	5/8 X 2 3/4	1/2-13	25
SO062030	5/8 X 3	1/2-13	10
SO062032	5/8 X 3 1/4	1/2-13	10
SO062035	5/8 X 3 1/2	1/2-13	10
SO062037	5/8 X 3 3/4	1/2-13	10
SO062040	5/8 X 4	1/2-13	10
*****	5/8 X 4 1/4	1/2-13	10
SO062045	5/8 X 4 1/2	1/2-13	10
SO062047	5/8 X 4 3/4	1/2-13	10
*****	5/8 X 5	1/2-13	10
*****	5/8 X 5 1/2	1/2-13	10
SO062060	5/8 X 6	1/2-13	10
*****	5/8 X 6 1/2	1/2-13	SEMI-STD



Tel.: (819) 346-2903 / (888) 345-2903 Fax.: (819) 346-3389

Email: distributeur@boulonstrie.com

B-70

VIS A ÉPAULEMENT À  
TÊTE CREUSE 6 PANS

NOIR / BARE  
ALLOY STEEL

SOCKET SHOULDER  
SCREWS

LA FINITION PLAQUÉE ZINC  
EST DISPONIBLE  
SUR DEMANDE



ZINC PLATED IS  
AVAILABLE ON REQUEST

NOTRE CODE	DESCRIPTION	FILET	QTÉ/BTE
OUR CODE	DESCRIPTION	THREAD	QTY/BOX
*****	5/8 X 7	1/2-13	SEMI-STD
SO062080	5/8 X 8	1/2-13	SEMI-STD
*****	3/4 X 1/2	5/8-11	SEMI-STD
*****	3/4 X 5/8	5/8-11	SEMI-STD
SO075007	3/4 X 3/4	5/8-11	SEMI-STD
*****	3/4 X 7/8	5/8-11	SEMI-STD
SO075010	3/4 X 1	5/8-11	SEMI-STD
SO075012	3/4 X 1 1/4	5/8-11	SEMI-STD
SO075015	3/4 X 1 1/2	5/8-11	10
SO075017	3/4 X 1 3/4	5/8-11	10
SO075020	3/4 X 2	5/8-11	10
SO075022	3/4 X 2 1/4	5/8-11	10
SO075025	3/4 X 2 1/2	5/8-11	10
SO075027	3/4 X 2 3/4	5/8-11	10
SO075030	3/4 X 3	5/8-11	10
*****	3/4 X 3 1/4	5/8-11	10
SO075035	3/4 X 3 1/2	5/8-11	10
*****	3/4 X 3 3/4	5/8-11	10
SO075040	3/4 X 4	5/8-11	10
*****	3/4 X 4 1/4	5/8-11	10
SO075045	3/4 X 4 1/2	5/8-11	10
*****	3/4 X 4 3/4	5/8-11	10
SO075050	3/4 X 5	5/8-11	10
SO075055	3/4 X 5 1/2	5/8-11	10
SO075060	3/4 X 6	5/8-11	10
SO075065	3/4 X 6 1/2	5/8-11	SEMI-STD
SO075070	3/4 X 7	5/8-11	SEMI-STD
SO090010	1 X 1	3/4-10	SEMI-STD
SO090012	1 X 1 1/4	3/4-10	SEMI-STD



Tel.: (819) 346-2903 / (888) 345-2903 Fax.: (819) 346-3389

Email: distributeur@boulonstrie.com

B-71

VIS A ÉPAULEMENT À  
TÊTE CREUSE 6 PANS

NOIR / BARE  
ALLOY STEEL

SOCKET SHOULDER  
SCREWS

LA FINITION PLAQUÉE ZINC  
EST DISPONIBLE  
SUR DEMANDE



ZINC PLATED IS  
AVAILABLE ON REQUEST

NOTRE CODE	DESCRIPTION	FILET	QTÉ/BTE
OUR CODE	DESCRIPTION	THREAD	QTY/BOX
SO090015	1 X 1 1/2	3/4-10	SEMI-STD
SO090017	1 X 1 3/4	3/4-10	SEMI-STD
SO090020	1 X 2	3/4-10	SEMI-STD
*****	1 X 2 1/4	3/4-10	SEMI-STD
SO090025	1 X 2 1/2	3/4-10	SEMI-STD
SO090027	1 X 2 3/4	3/4-10	SEMI-STD
SO090030	1 X 3	3/4-10	SEMI-STD
*****	1 X 3 1/4	3/4-10	SEMI-STD
*****	1 X 3 1/2	3/4-10	SEMI-STD
*****	1 X 4	3/4-10	SEMI-STD
*****	1 X 4 1/2	3/4-10	SEMI-STD
*****	1 X 5	3/4-10	SEMI-STD
*****	1 X 6	3/4-10	SEMI-STD
*****	1 X 6 1/2	3/4-10	SEMI-STD
*****	1 X 7	3/4-10	SEMI-STD
*****	1 1/4 X 2 1/4	7/8-9	SEMI-STD
*****	1 1/4 X 2 1/2	7/8-9	SEMI-STD
*****	1 1/4 X 2 3/4	7/8-9	SEMI-STD
*****	1 1/4 X 3	7/8-9	SEMI-STD
*****	1 1/4 X 3 1/4	7/8-9	SEMI-STD
*****	1 1/4 X 3 1/2	7/8-9	SEMI-STD
*****	1 1/4 X 4	7/8-9	SEMI-STD
*****	1 1/4 X 4 1/2	7/8-9	SEMI-STD
*****	1 1/4 X 5	7/8-9	SEMI-STD
*****	1 1/4 X 6	7/8-9	SEMI-STD



Tel.: (819) 346-2903 / (888) 345-2903 Fax.: (819) 346-3389  
Email: distributeur@boulonsestrie.com

B-72

**VIS À ÉPAULEMENT À  
TÊTE CREUSE 6 PANS  
GROS FILETS**

**NOIR / BARE**

**SOCKET SHOULDER SCREWS  
NATIONAL COARSE**

**MÉTRIQUE DIN 9841 METRIC**

**LA FINITION PLAQUÉE ZINC  
EST DISPONIBLE  
SUR DEMANDE**



**ZINC PLATED IS  
AVAILABLE ON REQUEST**

<b>NOTRE CODE</b>	<b>DESCRIPTION</b>	<b>FILET</b>	<b>QTÉ/BTE</b>
<b>OUR CODE</b>	<b>DESCRIPTION</b>	<b>THREAD</b>	<b>QTY/BOX</b>
SO106010	M6 X 1.00 X 10	M5 X .80	25
SO106012	M6 X 1.00 X 12	M5 X .80	25
SO106016	M6 X 1.00 X 16	M5 X .80	25
SO106020	M6 X 1.00 X 20	M5 X .80	25
*****	M6 X 1.00 X 25	M5 X .80	25
*****	M6 X 1.00 X 30	M5 X .80	25
*****	M6 X 1.00 X 40	M5 X .80	25
*****	M6 X 1.00 X 50	M5 X .80	25
SO108012	M8 X 1.25 X 12	M6 X 1.00	25
SO108016	M8 X 1.25 X 16	M6 X 1.00	25
*****	M8 X 1.25 X 20	M6 X 1.00	25
*****	M8 X 1.25 X 25	M6 X 1.00	25
*****	M8 X 1.25 X 30	M6 X 1.00	25
*****	M8 X 1.25 X 40	M6 X 1.00	25
*****	M8 X 1.25 X 50	M6 X 1.00	25
*****	M8 X 1.25 X 60	M6 X 1.00	25
*****	M8 X 1.25 X 70	M6 X 1.00	25
SO110016	M10 X 1.50 X 16	M8 X 1.25	25
SO110020	M10 X 1.50 X 20	M8 X 1.25	25
SO110025	M10 X 1.50 X 25	M8 X 1.25	25
*****	M10 X 1.50 X 30	M8 X 1.25	25
SO110040	M10 X 1.50 X 40	M8 X 1.25	25
*****	M10 X 1.50 X 50	M8 X 1.25	25
SO110060	M10 X 1.50 X 60	M8 X 1.25	25
*****	M10 X 1.50 X 70	M8 X 1.25	25
*****	M10 X 1.50 X 80	M8 X 1.25	25
SO112010	M12 X 1.75 X 10	M10 X 1.50	25
SO112012	M12 X 1.75 X 12	M10 X 1.50	25
SO112016	M12 X 1.75 X 16	M10 X 1.50	25



**Tel.: (819) 346-2903 / (888) 345-2903 Fax.: (819) 346-3389**

**Email: distributeur@boulonsestrie.com**

**B-73**

**VIS À ÉPAULEMENT À  
TÊTE CREUSE 6 PANS  
GROS FILETS**

**NOIR / BARE**

**SOCKET SHOULDER SCREWS  
NATIONAL COARSE**

**MÉTRIQUE DIN 9841 METRIC**

**LA FINITION PLAQUÉE ZINC  
EST DISPONIBLE  
SUR DEMANDE**

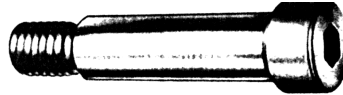

**ZINC PLATED IS  
AVAILABLE ON REQUEST**

NOTRE CODE	DESCRIPTION	FILET	QTÉ/BTE
OUR CODE	DESCRIPTION	THREAD	QTY/BOX
SO112020	M12 X 1.75 X 20	M10 X 1.50	25
*****	M12 X 1.75 X 25	M10 X 1.50	25
*****	M12 X 1.75 X 30	M10 X 1.50	25
SO112040	M12 X 1.75 X 40	M10 X 1.50	25
*****	M12 X 1.75 X 50	M10 X 1.50	25
SO112060	M12 X 1.75 X 60	M10 X 1.50	25
*****	M12 X 1.75 X 70	M10 X 1.50	25
*****	M12 X 1.75 X 80	M10 X 1.50	25
*****	M12 X 1.75 X 90	M10 X 1.50	25
*****	M12 X 1.75 X 100	M10 X 1.50	25
*****	M16 X 2.00 X 30	M12 X 1.75	25
*****	M16 X 2.00 X 40	M12 X 1.75	25
*****	M16 X 2.00 X 50	M12 X 1.75	25
*****	M16 X 2.00 X 60	M12 X 1.75	25
*****	M16 X 2.00 X 70	M12 X 1.75	25
*****	M16 X 2.00 X 80	M12 X 1.75	25
*****	M16 X 2.00 X 90	M12 X 1.75	25
*****	M16 X 2.00 X 100	M12 X 1.75	25
*****	M16 X 2.00 X 120	M12 X 1.75	25
*****	M20 X 2.50 X 40	M16 X 2.00	10
*****	M20 X 2.50 X 50	M16 X 2.00	10
*****	M20 X 2.50 X 60	M16 X 2.00	10
*****	M20 X 2.50 X 70	M16 X 2.00	10
*****	M20 X 2.50 X 80	M16 X 2.00	10
*****	M20 X 2.50 X 90	M16 X 2.00	10
*****	M20 X 2.50 X 100	M16 X 2.00	10
*****	M20 X 2.50 X 120	M16 X 2.00	10



**Tel.: (819) 346-2903 / (888) 345-2903 Fax.: (819) 346-3389**

**Email: distributeur@boulonsestrie.com**

**B-74**



VIS DE PRESSION  
À TÊTE CARRÉE  
GROS FILETS

NOIR / BARE

SQUARE HEAD  
SET SCREWS  
NATIONAL COARSE

LA FINITION PLAQUÉE ZINC  
EST DISPONIBLE  
SUR DEMANDE



ZINC PLATED IS  
AVAILABLE ON REQUEST

NOTRECODE	DESCRIPTION	QTÉ/BTE	NOTRECODE	DESCRIPTION	QTÉ/BTE
OUR CODE	DESCRIPTION	QTY/BOX	OUR CODE	DESCRIPTION	QTY/BOX
SQ025003	1/4-20 X 3/8	100	*****	3/8-16 X 7/8	100
SQ025005	1/4-20 X 1/2	100	SQ037010	3/8-16 X 1	100
SQ025006	1/4-20 X 5/8	100	SQ037012	3/8-16 X 1 1/4	100
SQ025007	1/4-20 X 3/4	100	SQ037015	3/8-16 X 1 1/2	100
SQ025008	1/4-20 X 7/8	100	SQ037017	3/8-16 X 1 3/4	100
SQ025010	1/4-20 X 1	100	SQ037020	3/8-16 X 2	100
SQ025012	1/4-20 X 1 1/4	100	SQ037022	3/8-16 X 2 1/4	100
SQ025015	1/4-20 X 1 1/2	100	SQ037025	3/8-16 X 2 1/2	100
SQ025017	1/4-20 X 1 3/4	100	SQ037030	3/8-16 X 3	50
SQ025020	1/4-20 X 2	100	*****	3/8-16 X 3 1/2	50
*****	1/4-20 X 2 1/4	100	SQ037040	3/8-16 X 4	50
*****	1/4-20 X 2 1/2	100	*****	3/8-16 X 4 1/2	50
SQ025030	1/4-20 X 3	100	SQ037050	3/8-16 X 5	50
SQ025035	1/4-20 X 3 1/2	100	SQ043007	7/16-14 X 3/4	100
SQ031005	5/16-18 X 1/2	100	SQ043010	7/16-14 X 1	100
SQ031006	5/16-18 X 5/8	100	SQ043012	7/16-14 X 1 1/4	100
SQ031007	5/16-18 X 3/4	100	SQ043015	7/16-14 X 1 1/2	100
SQ031008	5/16-18 X 7/8	100	SQ043017	7/16-14 X 1 3/4	100
SQ031010	5/16-18 X 1	100	SQ043020	7/16-14 X 2	50
SQ031012	5/16-18 X 1 1/4	100	*****	7/16-14 X 2 1/4	50
SQ031015	5/16-18 X 1 1/2	100	SQ043025	7/16-14 X 2 1/2	50
SQ031017	5/16-18 X 1 3/4	100	*****	7/16-14 X 3	50
SQ031020	5/16-18 X 2	100	SQ050040	7/16-14 X 4	50
*****	5/16-18 X 2 1/4	100	SQ050006	1/2-13 X 5/8	50
SQ031025	5/16-18 X 2 1/2	100	SQ050007	1/2-13 X 3/4	50
SQ031030	5/16-18 X 3	100	*****	1/2-13 X 7/8	50
SQ037005	3/8-16 X 1/2	100	SQ050010	1/2-13 X 1	50
SQ037006	3/8-16 X 5/8	100	SQ050012	1/2-13 X 1 1/4	50
SQ037007	3/8-16 X 3/4	100	SQ050015	1/2-13 X 1 1/2	50



Tel.: (819) 346-2903 / (888) 345-2903 Fax.: (819) 346-3389

Email: distributeur@boulonstrie.com

B-75

VIS DE PRESSION  
À TÊTE CARRÉE  
GROS FILETS

NOIR / BARE

SQUARE HEAD  
SET SCREWS  
NATIONAL COARSE

LA FINITION PLAQUÉE ZINC  
EST DISPONIBLE  
SUR DEMANDE



ZINC PLATED AVAILABLE  
ON REQUEST

NOTRECODE	DESCRIPTION	QTÉ/BTE	NOTRECODE	DESCRIPTION	QTÉ/BTE
OUR CODE	DESCRIPTION	QTY/BOX	OUR CODE	DESCRIPTION	QTY/BOX
SQ050017	1/2-13 X 1 3/4	50	SQ062025	5/8-11 X 2 1/2	25
SQ050020	1/2-13 X 2	50	*****	5/8-11 X 2 3/4	25
SQ050022	1/2-13 X 2 1/4	50	SQ062030	5/8-11 X 3	25
SQ050025	1/2-13 X 2 1/2	50	SQ062035	5/8-11 X 3 1/2	25
SQ050027	1/2-13 X 2 3/4	50	SQ062040	5/8-11 X 4	25
SQ050030	1/2-13 X 3	50	SQ062045	5/8-11 X4 1/2	25
SQ050035	1/2-13 X 3 1/2	25	SQ062050	5/8-11 X 5	25
SQ050040	1/2-13 X 4	25	*****	5/8-11 X 5 1/2	25
SQ050045	1/2-13 X 4 1/2	25	SQ062060	5/8-11 X 6	25
SQ050050	1/2-13 X 5	25	*****	3/4-10 X 1	25
SQ050060	1/2-13 X 6	25	SQ075012	3/4-10 X 1 1/4	25
*****	9/16-12 X 1	50	SQ075015	3/4-10 X 1 1/2	25
*****	9/16-12 X 1 1/4	50	SQ075017	3/4-10 X 1 3/4	25
*****	9/16-12 X 1 1/2	50	SQ075020	3/4-10 X 2	25
*****	9/16-12 X 1 3/4	50	*****	3/4-10 X 2 1/4	25
*****	9/16-12 X 2	50	SQ075025	3/4-10 X 2 1/2	25
*****	9/16-12 X 2 1/2	50	*****	3/4-10 X 2 3/4	25
SQ056030	9/16-12 X 3	50	SQ075030	3/4-10 X 3	25
*****	9/16-12 X 3 1/2	25	SQ075035	3/4-10 X 3 1/2	25
*****	9/16-12 X 4	25	SQ075040	3/4-10 X 4	25
SQ062006	5/8-11 X 5/8	50	SQ075045	3/4-10 X 4 1/2	25
SQ062007	5/8-11 X 3/4	50	SQ075050	3/4-10 X 5	25
*****	5/8-11 X 7/8	50	SQ075055	3/4-10 X 5 1/2	25
SQ062010	5/8-11 X 1	50	SQ075060	3/4-10 X 6	10
SQ062012	5/8-11 X 1 1/4	50	SQ075065	3/4-10 X 6 1/2	10
SQ062015	5/8-11 X 1 1/2	50	SQ075070	3/4-10 X 7	10
SQ062017	5/8-11 X1 3/4	50	SQ075075	3/4-10 X 7 1/2	10
SQ062020	5/8-11 X 2	25	SQ075080	3/4-10 X 8	10
SQ062022	5/8-11 X 2 1/4	25	SQ087020	7/8-9 X 2	10



Tel.: (819) 346-2903 / (888) 345-2903 Fax.: (819) 346-3389

Email: distributeur@boulonstrie.com

B-76

VIS DE PRESSION  
 À TÊTE CARRÉE  
 GROS FILETS

NOIR / BARE

SQUARE HEAD  
 SET SCREWS  
 NATIONAL COARSE

LA FINITION PLAQUÉE ZINC  
 EST DISPONIBLE  
 SUR DEMANDE



ZINC PLATED AVAILABLE  
 ON REQUEST

NOTRECODE	DESCRIPTION	QTÉ/BTE
OUR CODE	DESCRIPTION	QTY/BOX
SQ087025	7/8-9 X 2 1/2	10
SQ087030	7/8-9 X 3	10
SQ087035	7/8-9 X 3 1/2	10
SQ087040	7/8-9 X 4	10
SQ087045	7/8-9 X 4 1/2	10
SQ087050	7/8-9 X 5	10
*****	7/8-9 X 5 1/2	10
SQ087060	7/8-9 X 6	10
SQ087070	7/8-9 X 7	10
SQ087080	7/8-9 X 8	10
SQ090020	1-8 X 2	10
SQ090025	1-8 X 2 1/2	10
SQ090030	1-8 X 3	10
SQ090035	1-8 X 3 1/2	10
SQ090040	1-8 X 4	10
*****	1-8 X 4 1/2	10
*****	1-8 X 5	10
SQ090055	1-8 X 5 1/2	10
SQ090060	1-8 X 6	10
SQ090070	1-8 X 7	10
SQ090080	1-8 X 8	10
SQ090100	1-8 X 10	10

**AUSSI DISPONIBLE /  
 ALSO AVAILABLE**

**MÉTRIQUE DIN 479 METRIC**

**ET**

**ACIER INOXYDABLE  
 SS-304 / 18-8**

**STAINLESS STEEL  
 SS-304 / 18-8**

AUTRES DIMENSIONS DISPONIBLES / OTHER DIMENSIONS ARE AVAILABLE



Tel.: (819) 346-2903 / (888) 345-2903 Fax.: (819) 346-3389

Email: distributeur@boulonsestrie.com

B-77

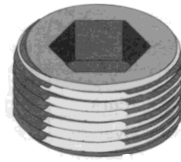

NOTRE CODE	DESCRIPTION	QTÉ/BTE
OUR CODE	DESCRIPTION	QTY/BOX
PP000062	1/16 NPT	100
PP000125	1/8 NPT	100
PP000250	1/4 NPT	100
PP000375	3/8 NPT	100
PP000500	1/2 NPT	100
PP000750	3/4 NPT	100
PP001000	1 NPT	100
PP001250	1 1/4 NPT	100
PP001500	1 1/2 NPT	100
*****	2 NPT	100

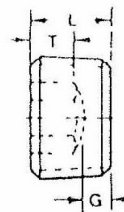
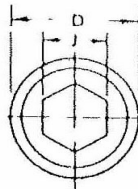

Nominal Size	D Nominal O. D.	Threads Per Inch	J Hexagon Socket Size Nominal	T Key Engagement Minimum	G Wall Thickness Minimum	L Overall Length			Tightening Torque Inch-Lbs.
						Nominal	Maximum	Minimum	
1/16	0,312	27	5/32	0,140	0,062	5/16	0,324	0,300	150
1/8	0,405	27	3/16	0,140	0,062	5/16	0,324	0,300	250
1/4	0,540	18	1/4	0,218	0,073	7/16	0,457	0,417	600
3/8	0,675	18	5/16	0,250	0,084	1/2	0,520	0,480	1200
1/2	0,840	14	3/8	0,312	0,095	9/16	0,583	0,542	1800
3/4	1,050	14	9/16	0,312	0,125	5/8	0,645	0,605	3000
1	1,315	11-1/2	5/8	0,375	0,125	3/4	0,770	0,730	4200
1-1/4	1,660	11-1/2	3/4	0,437	0,156	13/16	0,832	0,792	5400
1-1/2	1,900	11-1/2	1	0,437	0,156	13/16	0,843	0,780	6900
2	2,375	11-1/2	1	0,437	0,156	7/8	0,906	0,844	8500

## AUSSI DISPONIBLE / ALSO AVAILABLE

ACIER INOXYDABLE ET MÉTRIQUE / METRIC AND STAINLESS STEEL

LAITON / BRASS

BOUCHONS FILETÉS 7/8 HEXAGONE / PIPE PLUGS HEX 7/8

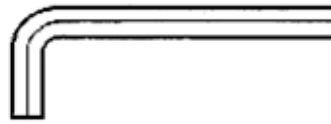

NOTRE CODE (COURTE )	NOTRE CODE (LONGUE)	DESCRIPTION	QUANTITÉ PAR PAQUET
OUR CODE (SHORT)	OUR CODE (LONG)	DESCRIPTION	UNIT PACKAGE QUANTITY
AK100028	-	.028	1
AK100035	AK200035	.035	1
AK100050	AK200050	.050	1
AK100062	AK200062	1/16	1
AK100078	AK200078	5/64	1
AK100093	AK200093	3/32	1
AK100109	AK200109	7/64	1
AK100125	AK200125	1/8	1
AK100140	AK200140	9/64	1
AK100156	AK200156	5/32	1
AK100187	AK200187	3/16	1
AK100218	AK200218	7/32	1
AK100250	AK200250	1/4	1
AK100315	AK200315	5/16	1
AK100375	AK200375	3/8	1
AK100437	AK200437	7/16	1
AK100500	AK200500	1/2	1
AK100562	AK200562	9/16	1
AK100625	AK200625	5/8	1
AK100750	AK200750	3/4	1
AK100875	AK200875	7/8	1
AK101000	AK201000	1	1



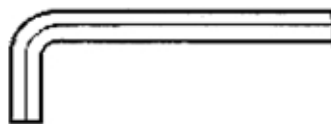

\*\*\*POUR LONGUEURS VOIR TECHNIQUE B (T-9)\*\*\* / \*\*\*FOR LENGTH SEE TECHNICAL B (T-9)\*\*\*

NOTRE CODE (COURTE )	NOTRE CODE (LONGUE)	DESCRIPTION	QTÉ/BTE
OUR CODE (SHORT)	OUR CODE (LONG)	DESCRIPTION	QTY/BOX
AK400015	AK500015	1.5 mm	100
AK400020	AK500020	2 mm	100
AK400025	AK500025	2.5 mm	100
AK400030	AK500030	3 mm	100
AK400040	AK500040	4 mm	100
AK400050	AK500050	5 mm	100
AK400060	AK500060	6 mm	100
AK400070	AK500070	7 mm	100
AK400080	AK500080	8 mm	100
-	AK500090	9 mm	100
AK400100	AK500100	10 mm	100
-	AK500110	11 mm	100
AK400120	AK500120	12 mm	50
AK400140	AK500140	14 mm	50
-	AK500170	17 mm	50
AK400190	AK500190	19 mm	25

AUTRES DIMENSIONS DISPONIBLES / OTHER DIMENSIONS ARE AVAILABLE

CLÉS HEXAGONALES  
BOUT EN ROND



HEX KEYS "ALLEN"  
BALL POINT

NOTRE CODE	DESCRIPTION	FORMAT
OUR CODE	DESCRIPTION	PACKAGE
AK600015	1.5 mm	1
AK600020	2 mm	1
AK600025	2.5 mm	1
AK600040	4 mm	1
AK600060	6 mm	1
AK600080	8 mm	1
AK600100	10 mm	1



Tel.: (819) 346-2903 / (888) 345-2903 Fax.: (819) 346-3389

Email: [distributeur@boulonsestrie.com](mailto:distributeur@boulonsestrie.com)

CLÉS HEXAGONALES  
BOUT EN ROND



HEX KEYS "ALLEN"  
BALL POINT

NOTRE CODE	DIM. DE LA CLÉ	LONGUEUR
OUR CODE	KEY SIZE	LENGHT
AK30050	.050"	2-13/16"
*****	1/16	3"
AK30078	5/64	3-3/16"
*****	3/32	3-13/32"
*****	7/64	3-19/32"
*****	1/8	3-13/16"
AK300140	9/64	3-29/32"
*****	5/32	4-3/32"
*****	3/16	4-1/2"
*****	7/32	4-29/32"
*****	1/4	5-3/16"
AK300315	5/16	6"
*****	3/8	6-13/16"
*****	7/16	7-1/2"
*****	1/2	8-5/16"
*****	9/16	9"
*****	5/8	9-13/16"
*****	3/4	11-5/16"

TOURNEVIS HEXAGONE  
BOUT EN ROND



HEX SCREWDRIVERS  
BALL POINT

NOTRE CODE	DIM. DE LA CLÉ	LONGUEUR DE LA LAME
OUR CODE	KEY SIZE	BLADE LENGHT
AK350050	.050"	4-11/16"
AK350062	1/16"	4-13/16"
AK350218	7/32"	7-11/16"
AK350250	1/4"	8-13/16"
AK350315	5/16"	9-13/32"
AK350375	3/8"	10-13/32"

AUTRES DIMENSIONS DISPONIBLES/OTHER DIMENSIONS ARE AVAILABLE



Tel.: (819) 346-2903 / (888) 345-2903 Fax.: (819) 346-3389  
Email: distributeur@boulonsestrie.com

B-81

INDIVIDUELLE / INDIVIDUAL

NOTRE CODE	DESCRIPTION
OUR CODE	DESCRIPTION
AK700093	3/32 X 9"
AK700109	7/64 X 4"
AK100124	1/8 X 4.6"
AK700125	1/8 X 7.6"
AK700126	1/8 X 9"
AK700140	9/64 X 4.5"
AK700156	5/32 X 5.2"
AK700187	3/16 X 6"
AK700218	7/32 X 6"
AK700312	5/16 X 6"



ENS. DE CLÉS HEXAGONALES MANCHE EN T

ALLEN KEYS T-HANDLE SETS

ENSEMBLES / SETS

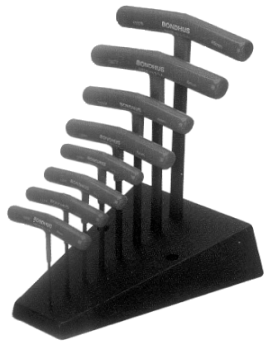

JEUX DE CLÉS  
HEX BOUT  
ROND ZINC

ALLEN KEYS SETS  
BALL DRIVER  
PLATED

NOTRE CODE	DESCRIPTION
OUR CODE	DESCRIPTION
OU016937	.050 À 3/8
OU017099	1.5 mm à 10 mm

NOTRE CODE	DESCRIPTION
OUR CODE	DESCRIPTION
OU013138	3/32 À 3/8
OU013189	2 mm À 10 mm
OU013190	3/32 À 3/8 W/S



ENS. CLÉS HEX  
BOUT ROND  
NOIR

ALLEN KEYS SETS  
BALL DRIVER  
PLAIN

"L"



NOTRE CODE	DESCRIPTION
OUR CODE	DESCRIPTION
OU010932	.050 À 5/32
OU010937	.050 À 3/8
OU010999	1.5 mm À 10 mm





ENS. CLÉS  
HEXAGONALES

ALLEN KEY  
SETS HEX

"L"

NOTRE CODE	DESCRIPTION
OU012137	.050 À 3/8
OU012199	1.5 mm À 10 mm

ENS. CLÉS HEXAGONALES / HEX FOLD UP

NOTRE CODE	DESCRIPTION	ENS. CLÉS TORX	DESCRIPTION
REF.: 12550	Combo (5/64 à 5/32) & 1.5 mm à 5 mm		
OU012585	3/16 À 3/8		
OU012587	2 mm À 8 mm	OU012634	TORX T9 X T40
OU012589	5/64 À 1/4		
OU012591	.050 À 3/16		
OU012592	1.5 mm À 6 mm		
OU012595	3 mm À 10 mm		

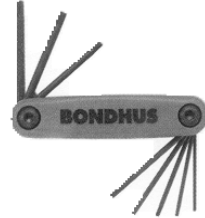

ENSEMBLES / SETS

TOURNEVIS BOUT Ronds	BALL POINT SCREWDRIVERS
NOTRE CODE	DESCRIPTION
OU010632	.050 À 5/32
OU010637	.050 À 3/8
OU010686	1.5 mm À 5 mm
OU010699	1.5 mm À 10 mm



ENSEMBLE DOUBLE DE CLÉS HEXAGONALES À BOUT ROND NOIR /  
DOUBLE PACK ALLEN KEY SETS BALL DRIVER PLAIN

NOTRE CODE	DESCRIPTION
OU022199	OU010999 (1.5 mm à 10 mm) & OU010937 (0.050 à 5/32)

ENSEMBLE DOUBLE DE CLÉS HEXAGONALES /  
DOUBLE PACK ALLEN KEY SETS HEX

NOTRE CODE	DESCRIPTION
OU020199	OU012137 (0.050 à 3/8) & OU012199 (1.5mm à 10 mm)



ENSEMBLE TRIPLE DE CLÉS HEXAGONALES À BOUT ROND NOIR & CLÉS HEX /  
TRIPLE PACK ALLEN KEY SETS BALL DRIVER PLAIN & HEX FOLD UP

NOTRE CODE	DESCRIPTION
OU014130	OU010937 (0.050 à 5/32) & OU010999 (1.5 mm à 10 mm) & OU012550 ( 5/64 à 5/32 & 1.5 mm à 5mm)

