

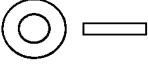

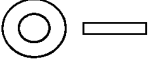

SECTION D

RONDELLES / WASHERS

INFORMATION TECHNIQUE.....DÉBUT DE LA SECTION
 TECHNICAL INFORMATION.....BEGINNING OF THIS SECTION

DESCRIPTION	SECTION-PAGE
 <p>RONDELLES PLATES USS, NOIR & ZINC. FLAT WASHERS USS, BARE & PLATED.</p>	D-1
 <p>RONDELLES PLATES, SS-304 & SS-316. FLAT WASHERS, SS-304 & SS-316.</p>	D-2
 <p>RONDELLES S.A.E, NOIR & ZINC. S.A.E WASHERS, BARE & PLATED.</p>	D-3
 <p>RONDELLES S.A.E, SS-304. S.A.E WASHERS, SS-304.</p>	SUR DEMANDE ON REQUEST
 <p>RONDELLES PLATES LARGES, ZINC. FLAT WASHERS FENDER, PLATED.</p>	D-3
 <p>RONDELLES PLATES LARGES, SS-304. FLAT WASHERS FENDER, SS-304.</p>	SUR DEMANDE ON REQUEST
 <p>RONDELLES PLATES MÉTRIQUE , DIN 125A , NOIR & ZINC. FLAT WASHERS DIN 125A, METRIC , BARE & PLATED.</p>	D-4
 <p>RONDELLES PLATES MÉTRIQUE DIN 125A , SS-304. FLAT WASHERS DIN 125A, METRIC, SS-304.</p>	D-4
 <p>RONDELLES PLATES, MÉTRIQUE DIN 125A , SS-316. FLAT WASHERS, DIN 125A METRIC , SS-316.</p>	SUR DEMANDE ON REQUEST
 <p>RONDELLES PLATES, LAITON. FLAT WASHERS, BRASS.</p>	D-5
 <p>RONDELLES PLATES, H.D.G. FLAT WASHERS, H.D.G.</p>	D-6
 <p>RONDELLES PLATE, L-9. FLAT WASHERS, L-9.</p>	D-6

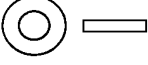
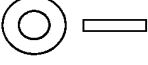
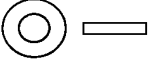
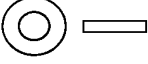
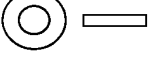
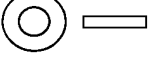









SECTION D

RONDELLES / WASHERS

DESCRIPTION	SECTION - PAGE
 <p>RONDELLES DE STRUCTURE, <i>ASTM F436</i>, NOIR. HARDENED STEEL WASHERS, <i>ASTM F436</i>, PLAIN.</p>	D-7
 <p>RONDELLES DE STRUCTURE, <i>ASTM F436</i>, ZINC ou JAUNE. HARDENED STEEL WASHERS, <i>ASTM F436</i>, PLATED or YELLOW.</p>	SUR DEMANDE ON REQUEST
 <p>RONDELLES DE STRUCTURE, <i>ASTM F436</i>, H.D.G. HARDENED STEEL WASHERS, <i>ASTM F436</i>, H.D.G.</p>	SUR DEMANDE ON REQUEST
 <p>RONDELLES BOMBÉES AVEC CAOUTCHOUC, ZINC. BONDED WASHERS, PLATED.</p>	D-8
 <p>RONDELLES BOMBÉES AVEC CAOUTCHOUC, SS-304. BONDED WASHERS, SS-304.</p>	SUR DEMANDE ON REQUEST
 <p>RONDELLES D'EMPLACEMENT. BEVEL WASHERS.</p>	D-8
 <p>RONDELLES PLATES EN NYLON. NYLON FLAT WASHERS.</p>	SUR DEMANDE ON REQUEST
 <p>RONDELLES DE FINITION. FINISHING WASHERS.</p>	SUR DEMANDE ON REQUEST
 <p>RONDELLES DE BLOCAGE, NOIR & ZINC. LOCK WASHERS, BARE & PLATED.</p>	D-9
 <p>RONDELLES DE BLOCAGE À COLLET ÉLEVÉ, ZINC. LOCK WASHERS HIGH COLLAR, PLATED.</p>	D-9
 <p>RONDELLES DE BLOCAGE, SS-304. LOCK WASHERS, SS-304.</p>	D-10
 <p>RONDELLES DE BLOCAGE, SS-316. LOCK WASHERS, SS-316.</p>	SUR DEMANDE ON REQUEST
 <p>RONDELLES DE BLOCAGE, ACIER ALLOY. LOCK WASHERS, ALLOY STEEL.</p>	D-10

SECTION D

RONDELLES / WASHERS

	DESCRIPTION	SECTION - PAGE
	RONDELLES DE BLOCAGE, H.D.G. LOCK WASHERS, H.D.G.	D-11
	RONDELLES DE BLOCAGE SILICONE BRONZE. LOCK WASHERS SILICON BRONZE.	D-11
	RONDELLES DE BLOCAGE, MÉTRIQUE <i>DIN 127B</i>, NOIR & ZINC. LOCK WASHERS, DIN 127B, METRIC, BARE & PLATED.	D-12
	RONDELLES DE BLOCAGE, MÉTRIQUE <i>DIN 127B</i>, SS-304 & SS-316. LOCK WASHERS, DIN 127B, METRIC, SS-304 & SS-316.	D-12
	RONDELLES DE BLOCAGE DENTÉES (INTÉRIEUR), ZINC. TOOTH LOCK WASHERS (INTERNAL), PLATED.	D-13
	RONDELLES DE BLOCAGE DENTÉES (EXTÉRIEUR), ZINC. TOOTH LOCK WASHERS (EXTERNAL), PLATED.	D-13
	RONDELLES DE BLOCAGE DENTÉES (EXTÉRIEUR 82 DEGRES), ZINC. TOOTH LOCK WASHERS (EXTERNAL 82 DEGRES), COUNTERSUNK, PLATED.	D-13
	RONDELLES DE BLOCAGE DENTÉES (EXTÉRIEUR-INTÉRIEUR), ZINC. TOOTH LOCK WASHERS (EXTERNAL-INTERNAL), PLATED.	D-13
	RONDELLES DE BLOCAGE NORD-LOCK. LOCK WASHERS NORD-LOCK.	SUR DEMANDE ON REQUEST
	RONDELLES DE BLOCAGE "Belleville". LOCK WASHERS DISC SPRINGS.	SUR DEMANDE ON REQUEST

INFORMATIONS TECHNIQUES / TECHNICAL INFORMATION

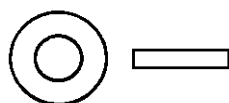

**RONDELLES PLATES USS
USS FLAT WASHERS**

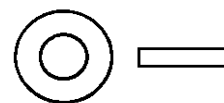

DIMENSION VIS / BOULONS SCREW / BOLT SIZE	DIAMÈTRE INTÉRIEUR HOLE DIAMETER	DIAMÈTRE EXTÉRIEUR OUTSIDE DIAMETER	ÉPAISSEUR / THICKNESS		QTÉ PAR 50 LBS
			GAUGE GAGE	POUCES INCHES	APPROX IN 50 LBS (PCES)
1/8	3/16	7/16	18	3/64	27700
3/16	1/4	9/16	18	3/64	14700
1/4	5/16	3/4	16	1/16	8100
5/16	3/8	7/8	14	5/64	4800
3/8	7/16	1	14	5/64	3730
7/16	1/2	1-1/4	13	3/32	1900
1/2	9/16	1-3/8	12	7/64	1370
9/16	5/8	1-1/2	12	7/64	1150
5/8	11/16	1-3/4	10	9/64	645
5/8 L	3/4	1-3/4	10	9/64	670
3/4	13/16	2	10	9/64	500
3/4 L	7/8	2	9	5/32	465
7/8	15/16	2-1/4	9	5/32	360
7/8 L	1	2-1/4	9	5/32	370
1	1-1/16	2-1/2	9	5/32	290
1 L	1-1/8	2-1/2	9	5/32	300
1-1/8	1-3/16	2-3/4	9	5/32	245
1-1/8 L	1-1/4	2-3/4	9	5/32	250
1-1/4	1-5/16	2-3/4	9	5/32	260
1-1/4 L	1-3/8	3	9	5/32	210
1-3/8	1-1/2	3-1/4	9	5/32	180
1-1/2	1-9/16	3-1/4	8	11/64	170
1-1/2 L	1-5/8	3-1/2	8	11/64	140
1-5/8	1-3/4	3-3/4	8	11/64	125
1-3/4	1-13/16	3-3/4	7	3/16	115
1-3/4 L	1-7/8	4	7	3/16	100
2	2-1/16	4-1/4	7	3/16	90
2 L	2-1/8	4-1/2	7	3/16	80



Tel.: (819) 346-2903 / (888) 345-2903 Fax.: (819) 346-3389

Email: distributeur@boulonsestrie.com

INFO TECHNIQUE D (T-1)

INFORMATIONS TECHNIQUES / TECHNICAL INFORMATION

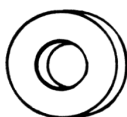

**RONDELLES S.A.E
S.A.E WASHERS**

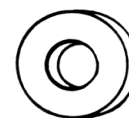

DIMENSION VIS / BOULONS	DIAMÈTRE INTÉRIEUR	DIAMÈTRE EXTÉRIEUR	ÉPAISSEUR / THICKNESS		QTÉ PAR 50 LBS
			GAUGE	POUCES	APPROX IN
SCREW / BOLT SIZE	HOLE DIAMETER	OUTSIDE DIAMETER	GAGE	INCHES	50 LBS (PCES)
NO.2	3/32	1/4	22	1/32	125000
NO.4	1/8	5/16	22	1/32	82500
NO.6(1/8)	5/32	3/8	18	3/64	40000
NO.8	3/16	7/16	18	3/64	27500
NO.10(3/16)	7/32	1/2	16	1/16	18500
1/4	9/32	5/8	16	1/16	12200
5/16	11/32	11/16	16	1/16	10600
3/8	13/32	13/16	16	1/16	7570
7/16	15/32	59/64	16	1/16	5680
1/2	17/32	1-1/16	13	3/32	2950
9/16	19/32	1-3/16	13	3/32	2370
5/8	21/32	1-5/16	13	3/32	1940
3/4	13/16	1-1/2	11	1/8	1180
7/8	15/16	1-3/4	11	1/8	860
1	1-1/16	2	11	1/8	655

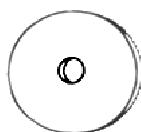

**RONDELLES PLATES LARGES
FLAT WASHERS FENDER**

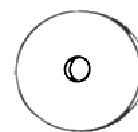

DIMENSION VIS / BOULONS	DIAMÈTRE INTÉRIEUR	DIAMÈTRE EXTÉRIEUR	ÉPAISSEUR / THICKNESS		QTÉ PAR 50 LBS
			GAUGE	POUCES	APPROX IN
SCREW / BOLT SIZE	HOLE DIAMETER	OUTSIDE DIAMETER	GAGE	INCHES	50 LBS (PCES)
3/16	13/64	3/4	18	3/64	9260
1/4	9/32	1-1/4	16	1/16	2500
5/16	11/2	1	16	1/16	4160
5/16	11/32	1-1/4	16	1/17	2630
5/16	11/32	1-1/2	16	1/18	1800
3/8	13/32	1-1/2	16	1/19	1750
1/2	17/32	2	16	1/20	980



Tel.: (819) 346-2903 / (888) 345-2903 Fax.: (819) 346-3389

Email: distributeur@boulonsestrie.com

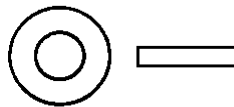

NOTRE CODE NOIR	DESCRIPTION	NOTRE CODE ZINC	DESCRIPTION	QTÉ/BTE
OUR CODE BARE	DESCRIPTION	OUR CODE PLATED	DESCRIPTION	QTY/BOX
*****	#4 BS (1/8 HS)	SNW277	#4 BS (1/8 HS)	100
WF100125	1/8 BS (3/16HS)	WF200125	1/8 BS (3/16 HS)	100
WF100187	3/16 BS (1/4 HS)	WF200187	3/16 BS (1/4 HS)	100
WF100250	1/4 BS (5/16 HS)	WF200250	1/4 BS (5/16 HS)	100
WF100315	5/16 BS (3/8HS)	WF200315	5/16 BS (3/8 HS)	100
WF100375	3/8 BS (7/16 HS)	WF200375	3/8 BS (7/16 HS)	100
WF100437	7/16 BS (1/2 HS)	WF200437	7/16 BS (1/2 HS)	50
WF100500	1/2 BS (9/16 HS)	WF200500	1/2 BS (9/16 HS)	50
WF100562	9/16 BS (5/8 HS)	WF200562	9/16 BS (5/8 HS)	25
WF100625	5/8 BS (11/16 HS)	WF200625	5/8 BS(11/16 HS)	25
*****	5/8 L BS (3/4 HS)	WF200626	5/8 L BS (3/4 HS)	20
WF100750	3/4 BS (13/16 HS)	WF200750	3/4 BS (13/16 HS)	20
*****	3/4L BS (7/8 HS)	*****	3/4 L BS (7/8 HS)	20
WF100875	7/8 BS (15/16 HS)	WF200875	7/8 BS (15/16 HS)	20
*****	7/8 L BS (1 HS)	WF200876	7/8 L BS (1 HS)	20
WF101000	1 BS (1 1/16 HS)	WF201000	1 BS (1 1/16 HS)	20
*****	1 L BS (1 1/8 HS)	*****	1 L BS (1 1/8 HS)	20
*****	1 1/8 BS (1 3/16 HS)	*****	1 1/8 BS (1 3/16 HS)	20
WF101125	1 1/8 L BS (1 1/4 HS)	WF201125	1 1/8 L BS (1 1/4 HS)	20
*****	1 1/4 BS (1 5/16 HS)	*****	1 1/4 BS (1 5/16 HS)	20
WF101250	1 1/4 L BS (1 3/8 HS)	WF201250	1 1/4 L BS (1 3/8 HS)	20
WF101375	1 3/8 BS (1 1/2 HS)	WF201375	1 3/8 BS (1 1/2 HS)	20
*****	1 1/2 BS (1 9/16 HS)	*****	1 1/2 BS (1 9/16 HS)	20
WF101500	1 1/2 L BS (1 5/8 HS)	WF201500	1 1/2 L BS (1 5/8 HS)	20
WF101625	1 5/8 BS (1 3/4 HS)	WF201625	1 5/8 BS (1 3/4 HS)	20
*****	1 3/4 BS (1 13/16 HS)	*****	1 3/4 BS (1 13/16 HS)	20
WF101750	1 3/4 L BS (1 7/8 HS)	WF201750	1 3/4 L BS (1 7/8 HS)	20
*****	2 BS (2 1/16 HS)	*****	2 BS (2 1/16 HS)	10
WF102000	2 L BS (2 1/8 HS)	WF202000	2 L BS (2 1/8 HS)	10

AUTRES DIMENSIONS DISPONIBLES / OTHER DIMENSIONS ARE AVAILABLE



Tel.: (819) 346-2903 / (888) 345-2903 Fax.: (819) 346-3389

Email: distributeur@boulonsestrie.com

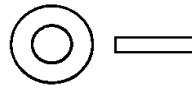

NOTRE CODE	DESCRIPTION	QTÉ/BTE
OUR CODE	DESCRIPTION	QTY/BOX
WS100004	#4 BS (.125 I.D) .312 O.D	100
WS100006	#6 BS (.149 I.D) 3/8 O.D	100
WS100008	#8 BS (.174 I.D) 3/8 O.D	100
WS100010	#10 BS (.203 I.D) 7/16 O.D	100
WS100250	1/4 BS (.281 I.D) 5/8 O.D	100
WS100315	5/16 BS (.343 I.D) 3/4 O.D	100
WS100375	3/8 BS (.406 I.D) 7/8 O.D	100
WS100437	7/16 BS (.500 I.D) 1-1/8 O.D	50
WS100500	1/2 BS (.531 I.D) 1-1/4 O.D	50
WS100562	9/16 BS (.625 I.D) 1-3/8 O.D	25
WS100625	5/8 BS (.687 I.D) 1-1/2 O.D	25
WS100750	3/4 BS (.812 I.D) 1-7/8 O.D	20
WS100875	7/8 BS (.937 I.D) 2 O.D	20
WS101000	1 BS (1.062 I.D) 2 O.D	20
WS101250	1 1/4 BS (1.312 I.D) 2-3/4 O.D	20
WS101500	1 1/2 BS (1.562 I.D) 3-1/4 O.D	15

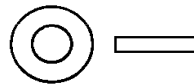

NOTRE CODE	DESCRIPTION	QTÉ/BTE
OUR CODE	DESCRIPTION	QTY/BOX
WS116187	3/16 BS (.203 I.D) 7/16 O.D	100
WS116250	1/4 BS (.281 I.D) 5/8 O.D	100
WS116315	5/16 BS (.343 I.D) 3/4 O.D	100
WS116375	3/8 BS (.406 I.D) 7/8 O.D	100
WS116437	7/16 BS (.500 I.D) 1 -1/8 O.D	50
WS116500	1/2 BS (.531 I.D) 1-1/4 O.D	50
WS116562	9/16 BS (.625 I.D) 1-3/8 O.D	50
WS116625	5/8 BS (.687 I.D) 1-1/2 O.D	25
WS116750	3/4 BS (.812 I.D) 1-7/8 O.D	20
WS116875	7/8 BS (.937 I.D) 2 O.D	20
WS116900	1 BS (1.062 I.D) 2 O.D	15
WS116912	1 1/8 BS (1.187 I.D) 2 1/2 O.D	15
WS116925	1 1/4 BS (1.312 I.D) 2-3/4 O.D	15
WS116950	1 1/2 BS (1.562 I.D) 3-1/4 O.D	15



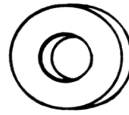

NOIR / BARE

ZINC / PLATED

NOTRE CODE	DESCRIPTION	NOTRE CODE	DESCRIPTION	QTÉ/BTE
OUR CODE	DESCRIPTION	OUR CODE	DESCRIPTION	QTY/BOX
*****	#4 BS (1/8 I.D)	*****	#4 BS (1/8 I.D)	100
WF500156	#6 (1/8) BS (5/32 I.D)	WF600125	#6 (1/8) BS (5/32 I.D)	100
WF500165	#8 BS (3/16 I.D)	*****	#8 BS (3/16 I.D)	100
WF500187	#10 (3/16) BS (7/32 I.D)	WF600187	#10 (3/16) BS (7/32 I.D)	100
WF500250	1/4 BS (9/32 I.D)	WF600250	1/4 BS (9/32 I.D)	100
WF500315	5/16 BS (11/32 I.D)	WF600315	5/16 BS (11/32 I.D)	100
WF500375	3/8 BS (13/32 I.D)	WF600375	3/8 BS (13/32 I.D)	100
WF500437	7/16 BS (15/32 I.D)	WF600437	7/16 BS (15/32 I.D)	50
WF500500	1/2 BS (17/32 I.D)	WF600500	1/2 BS (17/32 I.D)	50
WF500562	9/16 BS (19/32 I.D)	WF600562	9/16 BS (19/32 I.D)	25
WF500625	5/8 BS (21/32 I.D)	WF600625	5/8 BS (21/32 I.D)	25
WF500750	3/4 BS (13/16 I.D)	WF600750	3/4 BS (13/16 I.D)	25
WF500875	7/8 BS (15/16 I.D)	WF600875	7/8 BS (15/16 I.D)	20
WF501000	1 BS (1-1/16 I.D)	*****	1 BS (1-1/16 I.D)	20

RONDELLES PLATES
EXTÉRIEUR PLUS LARGE

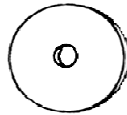

ZINC / PLATED

FLAT WASHERS FENDER

NOTRE CODE	DESCRIPTION	QTÉ/BTE
OUR CODE	DESCRIPTION	QTY/BOX
WF300187	3/16 BS (13/64 HS)	100
WF300250	1/4 BS (9/32 HS)	100
WF300313	5/16 BS (11/32 HS) X 1	100
WF300314	5/16 BS (11/32 HS) X 1 1/4	100
WF300315	5/16 BS (11/32 HS) X 1 1/2	100
WF300375	3/8 BS (13/32 HS)	100
WF300500	1/2 BS (17/32 HS)	50

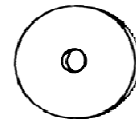
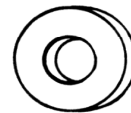

S.A.E. & FENDER

ACIER INOXYDABLE DISPONIBLE
STAINLESS STEEL AVAILABLE

AUTRES DIMENSIONS DISPONIBLES / OTHER DIMENSIONS ARE AVAILABLE



Tel.: (819) 346-2903 / (888) 345-2903 Fax.: (819) 346-3389

Email: distributeur@boulonstrie.com

NOIR / BARE ZINC / PLATED

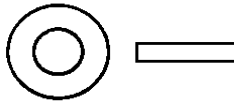

NOTRE CODE NOIR	NOTRE CODE ZINC	DIA. BOULON	DIA. INT.	DIA. EXT.	QTÉ/BTE
OUR CODE BARE	OUR CODE PLATED	BOLT SIZE	INSIDE DIA.	OUTSIDE DIA.	QTY/BOX
*****	WF600003	3 mm	3.2 mm	7.0 mm	100
*****	WF600004	4 mm	4.3 mm	9.0 mm	100
WF500005	WF600005	5 mm	5.3 mm	10.0 mm	100
WF500006	WF600006	6 mm	6.4 mm	12.0 mm	100
WF500007	WF600007	7 mm	7.4 mm	14.0 mm	100
WF500008	WF600008	8 mm	8.4 mm	16.0 mm	100
WF500010	WF600010	10 mm	10.5 mm	20.0 mm	100
WF500012	WF600012	12 mm	13.0 mm	24.0 mm	100
WF500014	WF600014	14 mm	15.0 mm	28.0 mm	50
WF500016	WF600016	16 mm	17.0 mm	30.0 mm	50
WF500018	WF600018	18 mm	19.0 mm	34.0 mm	25
WF500020	WF600020	20 mm	21.0 mm	37.0 mm	10
WF500022	*****	22 mm	23.0 mm	39.0 mm	10
WF500024	WF600024	24 mm	25.0 mm	44.0 mm	10
WF500030	WF600030	30 mm	31.0 mm	56.0 mm	10

RONDELLES PLATES
MÉTRIQUE
GRADE A-2

DIN 125 A
SS-304

FLAT WASHERS
METRIC
GRADE A-2

NOTRE CODE	DIA. BOULON	DIA. INT.	DIA. EXT.
OUR CODE	BOLT SIZE	INSIDE DIA.	OUTSIDE DIA.
WS500003	3 mm	3.2	7.0
WS500004	4 mm	4.3	9.0
WS500005	5 mm	5.3	10.0
WS500006	6 mm	6.4	12.0
WS500008	8 mm	8.4	16.0
WS500010	10 mm	10.5	20.0
WS500012	12 mm	13.0	24.0
WS500014	14 mm	15.0	28.0
WS500017	16 mm	17.0	30.0
WS500018	18 mm	19.0	34.0

AUTRES DIMENSIONS DISPONIBLES / OTHER DIMENSIONS ARE AVAILABLE

SS-316 / A-4 AUSSI DISPONIBLE / SS-316 / A-4 ALSO AVAILABLE



Tel.: (819) 346-2903 / (888) 345-2903 Fax.: (819) 346-3389

Email: distributeur@boulonstrie.com

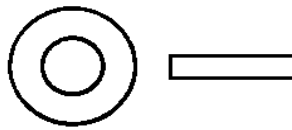

NOTRE CODE	DIA. BOULON	DIA. INT.	DIA. EXT.	QTÉ/BTE
OUR CODE	BOLT SIZE	INSIDE DIA.	OUTSIDE DIA.	QTY/BOX
WB10004	#4	.120	.281	100
WB10006	#6	.147	.312	100
WB100126	#6 L	.147	.375	100
WB100008	#8	.172	.375	100
WB100157	#8 L	.172	.437	100
WB100010	#10	.200	.437	100
WB100188	#10 L	.200	.500	100
WB100012	#12	.228	.500	100
WB100013	#12 L	.228	.562	100
WB100250	1/4	.260	.562	100
WB100251	1/4 L	.260	.687	100
WB100315	5/16	.340	.750	100
WB100316	5/16 L	.340	.875	100
WB100375	3/8	.392	.875	100
WB100376	3/8 L	.392	1.000	100
*****	7/16	.500	1.125	50
WB100500	1/2	.562	1.250	50
*****	1/2 L	.562	1.375	50
WB100562	9/16	.625	1.500	25
WB100625	5/8	.687	1.500	25
*****	5/8 L	.687	1.750	25
WB100750	3/4	.812	1.875	20
*****	3/4 L	.812	2.000	20
*****	7/8	.937	2.250	20
WB101000	1	1.062	2.500	15
WB101125	1 1/8	1.187	2.750	15
*****	1 1/4	1.313	3.000	15
WB101500	1 1/2	1.562	3.500	10

AUTRES DIMENSIONS DISPONIBLES / OTHER DIMENSIONS ARE AVAILABLE



Tel.: (819) 346-2903 / (888) 345-2903 Fax.: (819) 346-3389

Email: distributeur@boulonstrie.com

RONDELLES PLATES
GALVANISÉES À CHAUD

H.D.G.

FLAT WASHERS
HOT DIPPED GALVANIZED

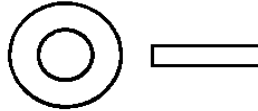

NOTRE CODE	DIA. BOULON	DIA. INT.	DIA. EXT.	QTÉ/BTE
OUR CODE	BOLT SIZE	INSIDE DIA.	OUTSIDE DIA.	QTY/BOX
WG000250	1/4	5/16	3/4	100
WG000315	5/16	3/8	7/8	100
WG000375	3/8	7/16	1	100
WG000500	1/2	9/16	1 3/8	50
WG000562	9/16	11/16	1 3/4	25
WG000625	5/8	13/16	2	25
WG000750	3/4	15/16	2 1/4	20
WG001000	1	1- 1/16	2 1/2	20
*****	1 1/8	1 -1/4	2 3/4	20
*****	1 1/4	1 5/16	2 3/4	20

RONDELLES DE TENSION ZINC DICHROMATE
TENSION WASHERS ZINC DICHROMATE

L-9

RONDELLES PLATES

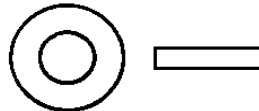

FLAT WASHERS

NOTRE CODE	DIA. BOULON	MAX	MIN	MAX	MIN	QTÉ/BTE
OUR CODE	BOLT SIZE	INSIDE DIA.		OUTSIDE DIA.		QTY/BOX
WG900250	1/4	0.286	0.276	0.640	0.620	100
WG900315	5/16	0.349	0.339	0.703	0.681	100
WG900375	3/8	0.411	0.401	0.827	0.805	100
WG900437	7/16	0.474	0.464	0.937	0.915	50
WG900500	1/2	0.536	0.526	1.092	1.055	50
WG900562	9/16	0.599	0.589	1.186	1.149	25
WG900625	5/8	0.663	0.649	1.342	1.305	25
WG900750	3/4	0.819	0.805	1.499	1.462	20
WG900875	7/8	0.945	0.931	1.780	1.743	20
WG901000	1	1.069	1.055	2.030	1.993	20
WG901125	1 1/8	1.195	1.181	2.030	1.993	15
WG901250	1 1/4	1.319	1.305	2.280	2.243	15
WG901500	1 1/2	1.572	1.552	2.780	2.743	10



Tel.: (819) 346-2903 / (888) 345-2903 Fax.: (819) 346-3389

Email: distributeur@boulonsestrie.com

D-6

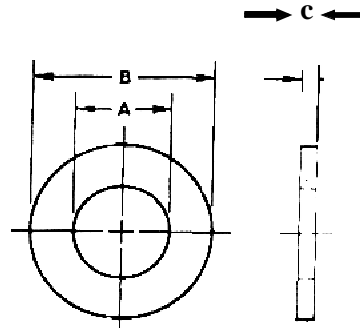

NOTRE CODE	DIM. RONDELLE	A	B	C	
		DIA. INT	DIA. EXT.	MIN	MAX
OUR CODE	WASHER SIZE	INSIDE DIA.	OUTSIDE DIA.	THICKNESS	
WS200500	1/2	1 1/16	17/32	0.097	0.177
WS200625	5/8	1 5/16	11/16	0.122	0.177
WS200750	3/4	1 15/32	13/16	0.122	0.177
WS200875	7/8	1 3/4	15/16	0.136	0.177
WS201000	1	2	1 1/8	0.136	0.177
WS201125	1 1/8	2 1/4	1 1/4	0.136	0.177
WS201250	1 1/4	2 1/2	1 3/8	0.136	0.177
*****	1 3/8	2 3/4	1 1/2	0.136	0.177
WS201500	1 1/2	3	1 5/8	0.136	0.177

DISPONIBLE / AVAILABLE

**ZINC OU JAUNE
PLATED OR YELLOW**

H.D.G.



Tel.: (819) 346-2903 / (888) 345-2903 Fax.: (819) 346-3389

Email: distributeur@boulonsestrie.com

**RONDELLES BOMBÉES
AVEC CAOUTCHOUC**

BONDED WASHERS



NOTRE CODE	DESCRIPTION	QTÉ/BTE
OUR CODE	DESCRIPTION	QTY/BOX
WB000008	#8 BS (1/2 O.D)	100
WB000010	#10 BS (1/2 O.D)	100
WB000014	1/4 BS (5/8 O.D)	100
WB000020	5/16 BS (3/4 O.D)	100
WB000037	3/8 BS (1 O.D)	100

AUSSI DISPONIBLE / ALSO AVAILABLE : SS304

**RONDELLES
D'EMPLACEMENT
ACIER NOIR**

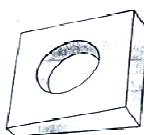

**BEVEL WASHERS
BARE STEEL**

NOTRE CODE	DESCRIPTION	QTÉ/BTE
OUR CODE	DESCRIPTION	QTY/BOX
WB000375	3/8	100
WB000500	1/2	50
WB000625	5/8	25
WB000750	3/4	20
WB000875	7/8	20
WB001000	1	20

AUSSI DISPONIBLE ... ALSO AVAILABLE ...



**RONDELLES PLATES EN NYLON
NYLON FLAT WASHERS**

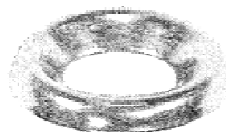

**RONDELLES DE FINITION
COUNTERSUNK
FINISHING WASHERS**



**(Nord-lock)
RONDELLES DE BLOCAGE
LOCK WASHERS**



**RONDELLES DE BLOCAGE "Belleville"
LOCK WASHERS DISC SPRINGS**

ET AUTRES ... & OTHERS ...



NOTRE CODE NOIR	NOTRE CODE ZINC	DESCRIPTION	LARGEUR	EPAISSEUR
OUR CODE BARE	OUR CODE PLATED	DESCRIPTION	WIDTH	THICKNESS
*****	WL200004	#4	.040"	.031"
WL100005	*****	#5	.047"	.031"
WL100006	WL200006	#6	.047"	.031"
*****	WL200008	#8	.055"	.040"
WL100187	WL200010	#10 (3/16)	.062"	.047"
WL100250	WL200250	1/4	.109"	.062"
WL100315	WL200315	5/16	.125"	.078"
WL100375	WL200375	3/8	.141"	.094"
WL100437	WL200437	7/16	.156"	.109"
WL100500	WL200500	1/2	.171"	.125"
WL100562	WL200562	9/16	.188"	.141"
WL100625	WL200625	5/8	.203"	.156"
WL100750	WL200750	3/4	.234"	.188"
WL100875	WL200875	7/8	.266"	.219"
WL101000	WL201000	1	.297"	.250"
WL101125	*****	1 1/8	.328"	.281"
WL101250	WL201250	1 1/4	.359"	.312"
WL101375	WL201375	1 3/8	.391"	.344"
WL101500	WL201500	1 1/2	.422"	.375"
WL102000	-	2	.500"	.375"

RONDELLES DE BLOCAGE
À COLLET ÉLEVÉ

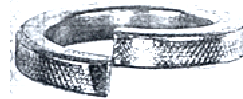

LOCK WASHERS
HIGH COLLAR

MODÈLE
À COLLET ÉLEVÉ
EST UTILISÉ
AVEC :



VIS À TÊTE
CYLINDRIQUE
À 6 PANS CREUX

NOTRE CODE	DESCRIPTION	QTÉ/BTE
OUR CODE	DESCRIPTION	QTY/BOX
WL210006	#6	100
WL210008	#8	100
WL210012	#12	100
WL210187	#10	100
WL210250	1/4	100
WL210315	5/16	100
WL210375	3/8	100
WL210437	7/16	50
WL210500	1/2	50
WL210562	9/16	25
WL210625	5/8	25
WL210750	3/4	20
WL210875	7/8	20
WL211000	1	20

HIGH-COLLAR
STYLE IS USED
WITH :



SOCKET HEAD
CAP SCREWS

RONDELLES DE BLOCAGE
EN ACIER INOXYDABLE

18-8
SS-304

LOCK WASHERS
STAINLESS STEEL



NOTRE CODE	DESCRIPTION	LARGEUR	EPAISSEUR	QTÉ/BTE
OUR CODE	DESCRIPTION	WIDTH	THICKNESS	QTY/BOX
WL600002	#2	.035"	.020"	100
WL600004	#4	.040"	.031"	100
WL600006	#6	.047"	.031"	100
WL600008	#8	.055"	.040"	100
WL600010	#10	.062"	.047"	100
WL600012	#12	.070"	.056"	100
WL600250	1/4	.109"	.062"	100
WL600315	5/16	.125"	.078"	100
WL600375	3/8	.141"	.094"	100
WL600437	7/16	.156"	.109"	50
WL600500	1/2	.171"	.125"	50
WL600562	9/16	.188"	.141"	25
WL600625	5/8	.203"	.156"	25
WL600750	3/4	.234"	.188"	20
WL600875	7/8	.266"	.219"	20
WL601000	1	.297"	.250"	20
WL601125	1 1/8	.328"	.281"	20

SS-316 EST AUSSI DISPONIBLE / SS-316 ALSO AVAILABLE

RONDELLES DE BLOCAGE
ACIER ALLOY



LOCK WASHERS
ALLOY STEEL

NOTRE CODE	DESCRIPTION	QTÉ/BTE
OUR CODE	DESCRIPTION	QTY/BOX
WL900187	3/16	100
WL900250	1/4	100
WL900315	5/16	100
WL900375	3/8	100
WL900437	7/16	50
WL900500	1/2	50
WL900625	5/8	25
WL900750	3/4	20
WL900875	7/8	
WL901000	1	20
WL901125	1 1/8	20
WL901250	1 1/4	20
WL901500	1 1/2	10

RONDELLES DE BLOPAGE
GALVANISÉES À CHAUD

H.D.G

LOCK WASHERS
HOT DIPPED GALVANIZED



NOTRE CODE	DESCRIPTION	QTÉ/BTE
OUR CODE	DESCRIPTION	QTY/BOX
WM100250	1/4	100
WM100315	5/16	100
WM100375	3/8	100
WM100500	1/2	50
WM100625	5/8	25
WM100750	3/4	20

SILICONE BRONZE

RONDELLES DE BLOPAGE
(EQUIVALENT LAITON)



LOCK WASHERS
(BRASS EQUIVALENT)

NOTRE CODE	DESCRIPTION	LARGEUR	EPAISSEUR
OUR CODE	DESCRIPTION	WIDTH	THICKNESS
WM200006	#6	.047"	.031"
WM200008	#8	.055"	.040"
WM200010	#10	.062"	.047"
WM200250	1/4	.109"	.062"
WM200315	5/16	.125"	.078"
WM200375	3/8	.141"	.094"
WM200437	7/16	.156"	.109"
WM200500	1/2	.171"	.125"
WM200625	5/8	.203"	.156"
WM200750	3/4	.234"	.188"
WM200875	7/8	.266"	.219"

AUTRES DIMENSIONS DISPONIBLES / OTHER DIMENSIONS ARE AVAILABLE



Tel.: (819) 346-2903 / (888) 345-2903 Fax.: (819) 346-3389
Email: distributeur@boulonsestrie.com

RONDELLES DE BLOCAGE
MÉTRIQUE
DIN 127B

NOIR / BARE
ZINC / PLATED

LOCK WASHERS
METRIC
DIN 127B



NOTRE CODE NOIR	OUR CODE ZINC	DESCRIPTION	INSIDE	OUTSIDE	THICK-
OUR CODE BARE	OUR CODE PLATED	DESCRIPTION	DIA.	DIA.	NESS
WL50003	WL510003	3 mm	3,1	6,2	0,8
WL50004	WL510004	4 mm	4,1	7,6	0,9
WL50005	WL510005	5 mm	5,1	9,2	1,2
WL50006	WL510006	6 mm	6,1	11,8	1,6
WL50007	*****	7 mm	7,1	12,8	1,6
WL50008	WL510008	8 mm	8,1	14,8	2
WL50010	WL510010	10 mm	10,2	18,1	2,2
WL50012	WL510012	12 mm	12,2	21,1	2,5
WL50014	*****	14 mm	14,2	24,1	3
WL50016	WL510016	16 mm	16,2	27,4	3,5
WL50018	WL510018	18 mm	18,2	29,4	3,5
WL50020	WL510020	20 mm	20,2	33,6	4
WL50022	*****	22 mm	22,5	35,9	4
WL50024	*****	24 mm	24,5	40	5
*****	*****	27 mm	27,5	43	5
*****	*****	30 mm	30,5	48,2	6
*****	*****	33 mm	33,5	55,2	6

AUTRES DIMENSIONS DISPONIBLES / OTHER DIMENSIONS ARE AVAILABLE

RONDELLES DE BLOCAGE
MÉTRIQUE

LOCK WASHERS
METRIC

SS-304 / A-2 / 18-8

SS-316 / A-4

NOTRE CODE SS-304	NOTRE CODE SS-316	DESCRIPTION	INSIDE	OUTSIDE	THICK-
OUR CODE SS-304	OUR CODE SS-316	DESCRIPTION	DIA.	DIA.	NESS
WL70003	*****	3 mm	3,1	6,2	0,8
WL70004	*****	4 mm	4,1	7,6	0,9
WL70005	*****	5 mm	5,1	9,2	1,2
WL70006	*****	6 mm	6,1	11,8	1,6
WL70008	*****	8 mm	8,1	14,8	2
WL70010	WL800010	10 mm	10,2	18,1	2,2
WL70012	WL800012	12 mm	12,2	21,1	2,5
WL70014	*****	14 mm	14,2	24,1	3
WL70016	*****	16 mm	16,2	27,4	3,5
WL70020	WL800020	20 mm	20,2	33,6	4

ZINC / PLATED

RONDELLES
DE BLOCAGE
EXTÉRIEUR



TOOTH LOCK
WASHERS
EXTERNAL

RONDELLES
DE BLOCAGE
INTÉRIEUR



TOOTH LOCK
WASHERS
INTERNAL

DISPONIBLE / AVAILABLE : SS

NOTRE CODE	DESCRIPTION	QTÉ/BTE
OUR CODE	DESCRIPTION	QTY/BOX
*****	#4	100
WL300006	#6	100
WL300008	#8	100
WL300010	#10	100
*****	#12	100
WL300250	1/4	100
WL300315	5/16	100
WL300375	3/8	100
WL300437	7/16	50
WL300500	1/2	50
WL300562	9/16	25
WL300625	5/8	25
WL300750	3/4	20
WL300875	7/8	20
WL301000	1	20

DISPONIBLE / AVAILABLE : SS

NOTRE CODE	DESCRIPTION	QTÉ/BTE
OUR CODE	DESCRIPTION	QTY/BOX
WL400002	#2	100
WL400004	#4	100
WL400006	#6	100
WL400008	#8	100
WL400010	#10	100
*****	#12	100
WL400250	1/4	100
WL400315	5/16	100
WL400375	3/8	100
WL400500	1/2	50
WL400562	9/16	25
WL400625	5/8	25
WL400750	3/4	20
WL400875	7/8	20
*****	1	20

AUSSI DISPONIBLE ... ALSO AVAILABLE ...

RONDELLES
DE BLOCAGE
EXTÉRIEUR
82 DEGRÉS



TOOTH LOCK
WASHERS
EXTERNAL
82 DEGRES

RONDELLES
DE BLOCAGE
EXTÉRIEUR-
INTÉRIEUR

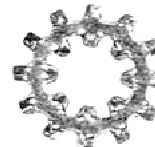

TOOTH LOCK
WASHERS
EXTERNAL -
INTERNAL

NOTRE CODE	DESCRIPTION	QTÉ/BTE
OUR CODE	DESCRIPTION	QTY/BOX
*****	#6	100
*****	#8	100
*****	#10	100
*****	#12	100
*****	1/4	100
*****	9/32	100
*****	5/16	100
*****	3/8	100
*****	7/16	50
*****	1/2	50

NOTRE CODE	DESCRIPTION	QTÉ/BTE
OUR CODE	DESCRIPTION	QTY/BOX
*****	#6	100
*****	#8	100
*****	#10	100
*****	1/4	100
*****	5/16	100
*****	3/8	100
*****	1/2	50
*****	5/8	25