















# SECTION I















## CÂBLE, CHÂÎNE ET ACCESSOIRES CABLE, CHAIN AND ACCESSORIES

INFORMATION TECHNIQUE.....DÉBUT DE LA SECTION  
TECHNICAL INFORMATION.....BEGINNING OF THIS SECTION

	DESCRIPTION	SECTION-PAGE
	CÂBLE D'AVIATION GALVANISÉ. GALVANIZED AIRCRAFT CABLE .	I-1
	CÂBLE D'AVIATION ACIER INOXYDABLE. STAINLESS STEEL AIRCRAFT CABLE .	I-2
	SERRE-CÂBLES GALVANISÉS. GALVANIZED MALLEABLE CLIPS.	I-2
	COSES À CÂBLE GALVANISÉS. GALVANIZED THIMBLES.	I-3
	BAGUES OVALES ALUMINIUM. ALUMINUM OVAL SLEEVES.	I-3
	BAGUES D'ARRÊT EN ALUMINIUM. ALUMINUM STOP SLEEVES.	SUR DEMANDE ON REQUEST
	EMBOUTISSEURS MANUELS. HAND SWAGERS.	I-4
	TENDEURS. TURNBUCKLES.	I-5
	CHÂÎNE EN ROULEAU. CHAIN ON REEL.	I-6
	CHÂÎNE À MAILLONS TORSADÉS. TWIST LINKS MACHINE CHAIN.	I-6
	CHÂÎNE À MAILLONS BLOQUÉS "TENSO". COIL CHAIN "TENSO".	I-6
	CHÂÎNE À CHASSIS. SASH CHAIN.	I-6
	CHÂÎNE À MAILLONS ORDINAIRES, GRADE 30. PROOF COIL CHÂÎNE , GRADE 30.	I-7
	CHÂÎNE DE TRANSPORT, GRADE 70 . TRANSPORT CHAIN, GRADE 70.	I-7





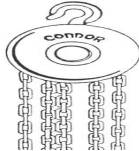
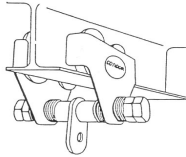







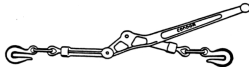

# SECTION I

## CÂBLE, CHÂÎNE ET ACCESSOIRES CABLE, CHAIN AND ACCESSORIES

	DESCRIPTION	SECTION-PAGE
	<b>CHAÎNE DE LEVAGE, GRADE 80. ALLOY LIFTING CHAINE, GRADE 80.</b>	I-7
	<b>COUPE BOULONS. BOLT CUTTERS.</b>	I-8
	<b>CROCHETS GRAPPINS À MANILLE, GRADE 30. CLEVIS GRAB HOOKS, GRADE 30.</b>	I-9
	<b>CROCHETS GRAPPINS À MANILLE, GRADE 70. CLEVIS GRAB HOOKS, GRADE 70.</b>	I-9
	<b>CROCHETS GRAPPINS À ŒIL, GRADE 30. EYE TYPE GRAB HOOKS, GRADE 30.</b>	I-9
	<b>CROCHETS COULISSANTS À MANILLE, GRADE 30. CLEVIS SLIP HOOKS, GRADE 30.</b>	I-10
	<b>CROCHETS COULISSANTS À MANILLE, GRADE 70. CLEVIS SLIP HOOKS, GRADE 70.</b>	I-10
	<b>CROCHETS COULISSANTS À ŒIL, GRADE 30. EYE TYPE SLIP HOOKS, GRADE 30.</b>	I-10
	<b>CROCHETS À ŒIL AVEC LINGUETS DE SÉCURITÉ. EYE HOOKS WITH SECURITY LATCH.</b>	I-11
	<b>LINGUETS. LATCHES.</b>	I-11
	<b>CROCHETS COULISSANTS À MANILLE, GRADE 70. CLEVIS SLIP HOOKS, GRADE 70.</b>	I-11
	<b>CROCHETS GRAPPINS À MANILLE, GRADE 70. CLEVIS GRAB HOOKS, GRADE 70.</b>	I-12
	<b>CROCHETS GRAPPINS À MANILLE, GRADE 80. CLEVIS GRAB HOOKS, GRADE 80.</b>	I-12
	<b>CROCHETS COULISSANTS D'ÉLINGUE À MANILLE. CLEVIS CHAIN SLIP HOOKS.</b>	I-12
	<b>PALANS À CHAÎNE / CHARIOTS. CHAIN BLOCK / TROLLEYS.</b>	I-13
		



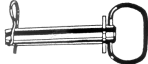











# SECTION I

## CÂBLE, CHÂÎNE ET ACCESSOIRES CABLE, CHAIN AND ACCESSORIES

DESCRIPTION	SECTION-PAGE	
	<b>MANILLES D'ANCRAGE. CLEVIS SCREWS.</b>	<b>I-14</b>
	<b>MAILLONS À RIVET. RIVET LINKS.</b>	<b>I-16</b>
	<b>MAILLONS RAPIDES . QUICK LINKS.</b>	<b>I-16</b>
	<b>MAILLONS FROIDS. STEEL COLD SHUT.</b>	<b>SUR DEMANDE ON REQUEST</b>
	<b>MAILLONS FENDUS. SPLIT REPAIR LINKS.</b>	<b>SUR DEMANDE ON REQUEST</b>
	<b>MAILLONS JUMEAUX. MID LINKS.</b>	<b>SUR DEMANDE ON REQUEST</b>
	<b>ATTACHES DE CHARGE . LOAD BINDERS.</b>	<b>I-8</b>
	<b>ELINGUES DE CHÂÎNE. CHAIN SLINGS.</b>	<b>SUR DEMANDE ON REQUEST</b>
	<b>ÉMÉRILLONS EN FONTE MALLÉABLE, <u>ZINC.</u> MALLEABLE IRON CHAIN SWIVEL, <u>PLATED.</u></b>	<b>SUR DEMANDE ON REQUEST</b>
	<b>GOUPILLES D'ATTACHE . LINCH PINS.</b>	<b>I-17</b>
	<b>ANNEAUX À CLÉ. KEY RINGS.</b>	<b>I-17</b>
	<b>ANNEAUX SOUDÉS. STEEL RINGS.</b>	<b>I-32</b>
	<b>GOUPILLES D'ATELAGE. HITCH PINS.</b>	<b>I-17</b>
	<b>TENDEURS DIVERS. TURNBUCKLES.</b>	<b>I-19</b>
	<b>PITONS AVEC ÉCROUS. EYE BOLTS &amp; NUTS.</b>	<b>I-20</b>

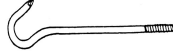
# SECTION I

## CÂBLE, CHÂÎNE ET ACCESSOIRES CABLE, CHAIN AND ACCESSORIES

DESCRIPTION	SECTION-PAGE
	<p><b>PITONS À BOIS, TIRE-FONDS. EYE LAG BOLTS.</b></p> <p style="text-align: right;"><b>I-22</b></p>
	<p><b>"A" SUITE , PETIT ŒILLETS À VIS . SCREW EYES "A" SUIT.</b></p> <p style="text-align: right;"><b>I-21</b></p>
	<p><b>"B" SUITE ,ŒILLETS À VIS MÉDIUM. MEDIUM SCREW EYES "B" SUIT.</b></p> <p style="text-align: right;"><b>I-21</b></p>
	<p><b>CROCHETS POUR TABLEAUX. PICTURE HANGERS.</b></p> <p style="text-align: right;"><b>I-23</b></p>
	<p><b>CROCHETS EN "S". "S" HOOKS.</b></p> <p style="text-align: right;"><b>I-23</b></p>
	<p><b>"M" SUIT CROCHETS VIS. SCREW HOOKS "M" SUIT.</b></p> <p style="text-align: right;"><b>I-23</b></p>
	<p><b>CROCHETS DE CORNICHE. CORNICHE HOOKS.</b></p> <p style="text-align: right;"><b>I-24</b></p>
	<p><b>CROCHETS DE TASSE, LAITON. BRASS SCREW (SHOULDER) HOOKS.</b></p> <p style="text-align: right;"><b>I-24</b></p>
	<p><b>CROCHETS DE TASSE, LAITON. CUP BRASS HOOKS.</b></p> <p style="text-align: right;"><b>I-24</b></p>
	<p><b>CROCHETS DE PORTE À ŒILLETS À VIS. GATE HOOKS AND SCREW EYES.</b></p> <p style="text-align: right;"><b>I-24</b></p>
	<p><b>CROCHETS DE CORDE À LINGE. CLOTHE LINE HOOKS.</b></p> <p style="text-align: right;"><b>SUR DEMANDE ON REQUEST</b></p>
	<p><b>BOULONS À ANNEAU AVEC ÉCROUS. RING BOLTS AND NUTS.</b></p> <p style="text-align: right;"><b>I-25</b></p>
	<p><b>ANNEAUX D'ACCROCHAGE À BOIS. HITCHING RING (LAG THREAD).</b></p> <p style="text-align: right;"><b>I-25</b></p>
	<p><b>ANNEAUX D'ACCROCHAGE (AVEC PLAQUE). HITCHING RINGS (PLATE STYLE).</b></p> <p style="text-align: right;"><b>I-25</b></p>
	<p><b>MOUSQUETONS DIVERS. VARIOUS SNAPS.</b></p> <p style="text-align: right;"><b>I-26</b></p>

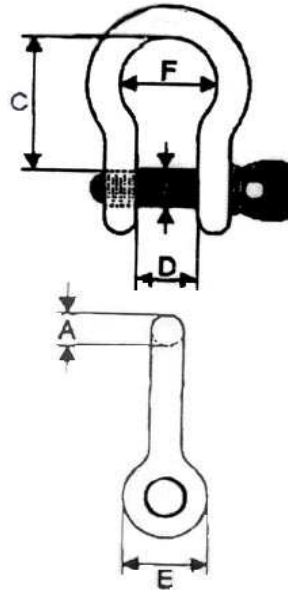

DIMENSION	CHARGE ADM.	DIAM. TIGE	DIMENSIONS (POUCES)			
SIZE	WLL	PIN DIAMETER	DIMENSIONS (INCHES)			
(A)	(TONNE/TON)		C	D	E	F
3/16	1/3	1/4	0,88	0,38	0,56	0,63
1/4	1/2	5/16	1,06	0,47	0,66	0,75
5/16	3/4	3/8	1,25	0,53	0,81	0,84
3/8	1	7/16	1,44	0,63	0,97	1,00
7/16	1 1/2	1/2	1,69	0,75	1,06	1,13
1/2	2	5/8	1,88	0,81	1,31	1,25
5/8	3 1/4	3/4	2,44	1,06	1,56	1,69
3/4	4 3/4	7/8	2,88	1,19	1,88	1,94
7/8	6 1/2	1	3,38	1,44	2,13	2,19
1	8 1/2	1 1/8	3,81	1,69	2,38	2,63
1 1/8	9 1/2	1 1/4	4,25	1,75	2,63	2,88
1 1/4	12	1 3/8	4,69	2,00	3,00	3,13
1 3/8	13 1/2	1 1/2	5,31	2,13	3,25	3,50
1 1/2	17	1 5/8	5,69	2,31	3,50	3,75
1 3/4	25	2	7,06	2,88	4,25	4,88
2	35	2 1/4	7,75	3,31	4,88	5,44



Tel.: (819) 346-2903 / (888) 345-2903 Fax.: (819) 346-3389

Email: distributeur@boulonstrie.com



**CLASSIFICATION 7 X 19**

NOTRE CODE	DESCRIPTION	RÉSISTANCE À LA RUPTURE	
OUR CODE	DESCRIPTION	BREAKING STRENGTH	
*****	1/16	480	LBS
CH200093	3/32	1000	LBS
CH200094	3/32 X 250'	1000	LBS
CH200095	3/32 X 500'	1000	LBS
CH200096	3/32 X 1000'	1000	LBS
CH200125	1/8	2000	LBS
CH200126	1/8 X 250'	2000	LBS
CH200127	1/8 X 500'	2000	LBS
CH200128	1/8 X 1000'	2000	LBS
*****	5/32	2800	LBS
CH200187	3/16	4200	LBS
CH200188	3/16 X 250'	4200	LBS
CH200189	3/16 X 500'	4200	LBS
CH200190	3/16 X 1000'	4200	LBS
*****	7/32	5600	LBS
CH200250	1/4 x 100'	7000	LBS
CH200251	1/4 X 250'	7000	LBS
CH200252	1/4 X 500'	7000	LBS
CH200253	1/4 X 1000'	7000	LBS
CH200315	5/16	9800	LBS
CH200316	5/16 X 250'	9800	LBS
CH200317	5/16 X 500'	9800	LBS
CH200318	5/16 X 1000'	9800	LBS
CH200375	3/8	14400	LBS
CH200376	3/8 X 150'	14400	LBS
CH200377	3/8 X 250'	14400	LBS
CH200378	3/8 X 500'	14400	LBS
CH200379	3/8 X 1000'	14400	LBS

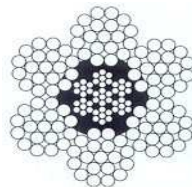

**CLASSIFICATION 6 X 19**

NOTRE CODE	DESCRIPTION	RÉSISTANCE À LA RUPTURE	
OUR CODE	DESCRIPTION	BREAKING STRENGTH	
CH200500	1/2	20700	LBS
CH200501	1/2 X 250'	20700	LBS
CH200502	1/2 X 500'	20700	LBS

CÂBLE D'AVIATION  
 ACIER INOXYDABLE  
 \*\*\* 304 \*\*\*



AIRCRAFT CABLE  
 STAINLESS STEEL  
 \*\*\* 304 \*\*\*

**CLASSIFICATION 7 X 19**

NOTRE CODE	DESCRIPTION	RÉSISTANCE À LA RUPTURE	
OUR CODE	DESCRIPTION	BREAKING STRENGTH	
*****	1/16	480	LBS
*****	3/32	1100	LBS
CH201125	1/8	1700	LBS
*****	5/32	2900	LBS
CH201187	3/16	3700	LBS
*****	7/32	5000	LBS
CH201250	1/4	6400	LBS
*****	5/16	9400	LBS
CH201375	3/8	12000	LBS

**AUSSI DISPONIBLE / ALSO AVAILABLE:  
 ACIER INOXYDABLE 316 / STAINLESS STEEL 316**

SERRE-CÂBLES  
 GALVANISÉS



GALVANIZED  
 MALLEABLE CLIPS

NOTRE CODE	DIMENSION	
OUR CODE	DIMENSION	
CH300125	1/8	<b>AUSSI DISPONIBLE /            ALSO AVAILABLE :</b>  <b>ACIER INOXYDABLE 304 &amp; 316</b>  <b>STAINLESS STEEL 304 &amp; 316</b>
CH300187	3/16	
CH300250	1/4	
CH300315	5/16	
CH300375	3/8	
*****	7/16	
CH300500	1/2	
CH300625	5/8	
CH300750	3/4	
CH300875	7/8	
CH301000	1	



Tel.: (819) 346-2903 / (888) 345-2903 Fax.: (819) 346-3389  
 Email: distributeur@boulonstrie.com

**COSSES À CÂBLE STANDARDS  
GALVANISÉES**



**STANDARD THIMBLES  
GALVANIZED**

NOTRE CODE	DIMENSION
OUR CODE	DIMENSION
CH400125	1/8
CH400187	3/16
CH400250	1/4
CH400315	5/16
CH400375	3/8
CH400500	1/2
*****	5/8
CH400750	3/4
*****	7/8

**BAGUES OVALES EN ALUMINIUM**

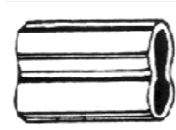

**ALUMINUM OVAL SLEEVES**

NOTRE CODE	DIMENSION
OUR CODE	DIMENSION
CH140876	1/16
CH140877	1/8
CH140878	3/16
CH140879	1/4
CH140880	5/16
CH140881	3/8
CH140883	1/2

**SUR DEMANDE /  
ON REQUEST**



**BAGUES D'ARRÊT EN ALUMINIUM  
ALUMINUM STOP SLEEVES**

**NOUS POUVONS VOUS FOURNIR TOUTE LA GAMME  
D'ACCESSOIRES SE RAPPORTANT AU CÂBLE D'ACIER /  
WE CAN SUPPLY YOU ALL THE STEEL CABLE ACCESSORIES**



**Tel.: (819) 346-2903 / (888) 345-2903 Fax.: (819) 346-3389  
Email: distributeur@boulonsestrie.com**



**OU000HS5**

**EMBOUTISSOIR À MULTICOMPRESSION MUNI D'UN COUPE-CÂBLE  
MULTICOMPRESSION HAND SWAGER WITH CABLE CUTTER  
LONGUEUR / LENTH : 28"**

<b>POUR BAGUES OVALES / FOR OVAL SLEEVES</b>	<b>POUR BAGUES D'ARRÊT / FOR STOP SLEEVES</b>
<b>1/16 - 3/32 - 1/8 - 5/32 - 3/16</b>	<b>1/16 - 3/32 - 1/8 - 5/32 - 3/16 - 7/32</b>

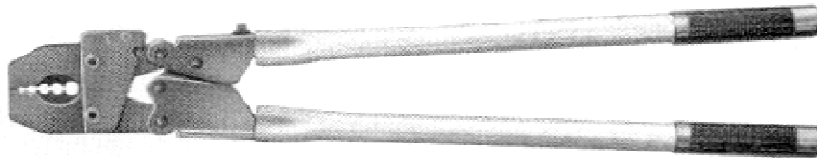

**EMBOUTISSOIR À MAIN, 1 CAVITÉ (REF. HS-1B)  
HAND SWAGER, 1 CAVITY (REF. HS-1B)  
LONGUEUR / LENTH : 20"**

<b>DISPONIBLE POUR: POUR BAGUES OVALES / FOR OVAL SLEEVES</b>	<b>POUR BAGUES D'ARRÊT / AVAILABLE FOR: FOR STOP SLEEVES</b>
<b>7/32 OU 1/4 OU 9/32 OU 5/16</b>	<b>1/4 - 9/32 - 5/16</b>

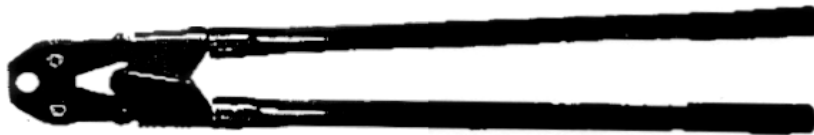

**PETIT EMBOUTISSOIR MANUEL COMPACT  
SMALL AND COMPACT HAND SWAGER  
LONGUEUR / LENTH : 9"**

<b>POUR BAGUES OVALES / FOR OVAL SLEEVES</b>	<b>POUR BAGUES D'ARRÊT / FOR STOP SLEEVES</b>
<b>1/32 - 3/64 - 1/16</b>	<b>1/32 - 3/64 - 1/16</b>

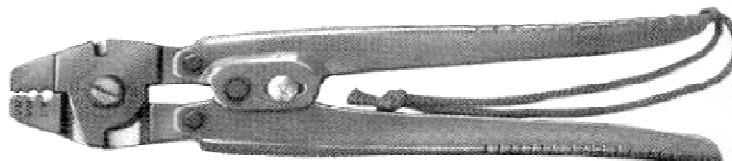

TENDEURS  
GALVANISÉS,  
ACIER FORGÉ

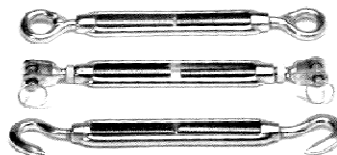

TURNBUCKLES  
GALVANIZED  
DROP-FORGED

DIMENSION	ŒIL & ŒIL	CROCHET ET CROCHET	MÂCHOIR & MÂCHOIR
DIMENSION	EYE & EYE	HOOK & HOOK	JAW & JAW
DIAMÈTRE X AJUSTEMENT	CHARGE ADM. (LBS)	CHARGE ADM. (LBS)	CHARGE ADM. (LBS)
DIAMETER X TAKE UP	ADM. CHARGE (LBS)	ADM. CHARGE (LBS)	ADM. CHARGE (LBS)
3/8 X 6	1200	1000	1200
1/2 X 6	2200	1500	2200
1/2 X 9	2200	1500	2200
1/2 X 12	2200	1500	2200
5/8 X 6	3500	2250	3500
5/8 X 9	3500	2250	3500
5/8 X 12	3500	2250	3500
3/4 X 6	5200	3000	5200
3/4 X 9	5200	3000	5200
3/4 X 12	5200	3000	5200
3/4 X 18	5200	3000	5200
7/8 X 12	7200	4000	7200
7/8 X 18	7200	4000	7200
1 X 12	10000	5000	10000
1 X 18	10000	5000	10000
1 X 24	10000	5000	10000
1 1/4 X 12	15200	5000	15200
1 1/4 X 18	15200	5000	15200
1 1/2 X 12	21400	7500	21400
1 1/2 X 18	21400	7500	21400

TENDEURS  
À ERGOT



TURNBUCKLES  
ROD END

DIAMÈTRE X AJUSTEMENT	CHARGE ADM. (LBS)
DIAMETER X TAKE UP	ADM. CHARGE (LBS)
3/8 X 6	1200
1/2 X 6	2200
5/8 X 6	3500
3/4 X 6	5200
7/8 X 6	7200
1 X 6	10000

CORPS SEULEMENT EST DISPONIBLE / BODY ONLY IS AVAILABLE  
AUTRES DIMENSIONS DISPONIBLE / OTHER DIMENSIONS ARE AVAILABLE

CHAÎNE EN ROULEAU  
CHAÎNE À MAILLONS  
ORDINAIRES  
ZINC

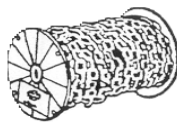

CHAIN ON REEL  
PROOF COIL CHAIN  
PLATED

GRADE 30

NOTRE CODE	DIMENSION	QTÉ/ROULEAU	EFFORT ADMISSIBLE, LBS
OUR CODE	DIMENSION	QTY/ROLL	SAFE WORKING LOAD, LBS
*****	1/8	198'	300
*****	5/32	98'	375
CH141044	3/16	98'	630
CH141045	1/4	98'	1100
CH141046	5/16	75'	1700
CH141047	3/8	49'	2400

CHAÎNE À MAILLONS TORSADÉS  
ZINC

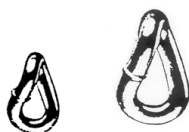

TWIST LINKS MACHINE CHAIN  
PLATED

NOTRE CODE	NO - (DIA. FIL)	QTÉ/ROULEAU	EFFORT ADMISSIBLE, LBS
OUR CODE	NO - (WIRE DIA.)	QTY/ROLL	SAFE WORKING LOAD, LBS
CH141043	4 - (1/8")	98'	200
*****	2 - (5/32")	98'	287
CH141042	2/0 - (3/16")	75'	520

CHAÎNE À MAILLONS BLOQUÉS  
"TENSO"  
ZINC



COIL CHAIN  
"TENSO"  
PLATED

NOTRE CODE	NO - (DIA. FIL)	QTÉ/ROULEAU	EFFORT ADMISSIBLE, LBS
OUR CODE	NO - (WIRE DIA.)	QTY/ROLL	SAFE WORKING LOAD, LBS
*****	4 - (.079")	197'	70
*****	3 - (.080")	197'	90
CH141049	1 - (.103")	98'	155
*****	2/0 - (.135")	180'	255

CHAÎNE À CHASSIS  
ZINC



SASH CHAIN  
PLATED

NOTRE CODE	DIMENSION	QTÉ/ROULEAU	EFFORT ADMISSIBLE, LBS
OUR CODE	DIMENSION	QTY/ROLL	SAFE WORKING LOAD, LBS
*****	8	197'	75
CH141048	80 OU /OR 35	98'	106

CHAÎNE À MAILLONS  
ORDINAIRES  
GRADE 30

PROOF COIL  
CHAIN  
GRADE 30



**ZINC / PLATED**

NOTRE CODE	DIMENSION	CHARGE ADM. LBS	POIDS APPROX / 100 PI. LBS
OUR CODE	DIMENSION	LOAD LIMIT. LBS	APPROX WEIGHT / 100 FT. LBS
CH141019	1/8	300 lbs	20.39
CH141025	3/16	630 lbs	39.35
CH141030	1/4	1100 lbs	63.60
CH141035	5/16	1900 lbs	100.62
CH141040	3/8	2650 lbs	145.63
CH141041	1/2	4500 lbs	263.68

GALVANISÉ ET ACIER NOIR DISPONIBLE / GALVANIZED AND BARE STEEL IS AVAILABLE

**ATTENTION: LES CHAÎNES GRADE 30 NE SONT PAS CONÇUES POUR DES APPLICATIONS DE LEVAGE.**

CHAÎNE DE TRANSPORT  
GRADE 70

TRANSPORT CHAIN  
GRADE 70

**PLAQUÉE AU CHROMATE JAUNE / CHROMATE YELLOW PLATED**

NOTRE CODE	DIMENSION	CHARGE ADM. LBS	POIDS APPROX / 100 PI. LBS
OUR CODE	DIMENSION	LOAD LIMIT. LBS	APPROX WEIGHT / 100 FT. LBS
CH141050	1/4	3150 lbs	61.47
CH141060	5/16	4700 lbs	93.95
CH141065	3/8	6600 lbs	145.62
CH141066	1/2	11300 lbs	263.68

**ATTENTION: LES CHAÎNES GRADE 70 NE SONT PAS CONÇUES POUR DES APPLICATIONS DE LEVAGE.**

CHAÎNE DE LEVAGE EN ACIER ALLIÉ  
GRADE 80

ALLOY LIFTING CHAIN  
GRADE 80

NOTRE CODE	DIMENSION	CHARGE ADM. LBS	POIDS APPROX / PI. LBS
OUR CODE	DIMENSION	LOAD LIMIT. LBS	APPROX WEIGHT / FT. LBS
*****	9/32	3500	.71
*****	3/8	7100	.144
*****	1/2	12000	.236
*****	5/8	18100	.380
*****	3/4	28300	.556

## COUPE-BOULONS / BOLT CUTTERS

COUPE-BOULONS  
À COUPE CENTRALE

BOLT CUTTERS FOR  
CENTRAL CUT

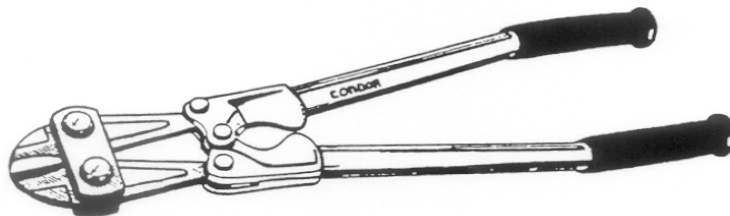

NOTRE CODE	LONGUEUR	CAP. COUPE
OUR CODE	LENGTH	CUTTING CAP.
OU00BC10	18"	5/16
*****	24"	3/8
*****	36"	5/8

JEU DE MACHOÎRES  
AVEC PLAQUE

REPLACEMENT SET OF  
JAWS WITH PLATES

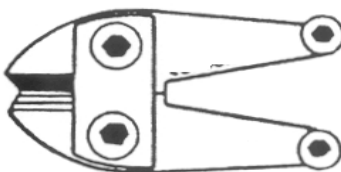

NOTRE CODE	LONGUEUR	EMB.
OUR CODE	LENGTH	PACK
*****	18"	1
*****	24"	1
*****	36"	1

ATTACHES DE CHARGE

LOAD BINDERS

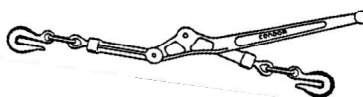

NO. CODE	CAP. CHAÎNE	OUVERTURE	LONGUEUR LEVIER	EFFORT ADM.	RESIS. À LA RUPTURE
OUR CODE	CHAIN CAP.	OPEN SPREAD	LEVER LENGTH	SAFE WORKING	BREAKING STRENGTH
CH141070	1/4"	15-1/2"	13"	1250 LB	5 300 LB
CH141071	5/16" - 3/8"	22-1/2"	16"	5400 LB	19 000 LB
*****	3/8" - 1/2"	28-1/2"	18-1/2"	9200 LB	33 000 LB



Tel.: (819) 346-2903 / (888) 345-2903 Fax.: (819) 346-3389

Email: [distributeur@boulonsestrie.com](mailto:distributeur@boulonsestrie.com)

**CROCHETS FORGÉS POUR CHAÎNE / FORGED CHAIN HOOKS**

**CROCHETS GRAPPIN  
A MANILLE**



**CLEVIS GRAB  
HOOKS**

**GRADE 30**

**ACIER AU CARBONE COULEUR GRIS / CARBON STEEL COLOUR GREY**

NOTRE CODE	DESCRIPTION	CHARGE AMD. (lbs)
OUR CODE	DESCRIPTION	SAFE WORKING LOAD
CH140330	1/4	2600
CH140340	5/16	3900
CH140350	3/8	5400
CH140360	7/16	7200
CH140370	1/2	9200

**GRADE 70**

**ACIER D'ALLIAGE DE CHROMATE JAUNE / CHROMATE YELLOW STEEL PLATED**

NOTRE CODE	DESCRIPTION	CHARGE AMD. (lbs)
OUR CODE	DESCRIPTION	SAFE WORKING LOAD
CH140335	1/4	3150
CH140345	5/16	4700
CH140355	3/8	6600
CH140361	7/16	8800
*****	1/2	11300

**CROCHETS  
GRAPPIN A CEIL**



**EYE TYPE  
GRAB HOOKS**

**GRADE 30**

**ACIER AU CARBONE COULEUR GRIS / CARBON STEEL COLOUR GREY**

NOTRE CODE	DESCRIPTION	CHARGE AMD. (lbs)
OUR CODE	DESCRIPTION	SAFE WORKING LOAD
*****	1/4	2600
*****	5/16	3900
*****	3/8	5400

## CROCHETS FORGÉS POUR CHAÎNE / FORGED CHAIN HOOKS

CROCHETS GRAPPIN  
À MANILLE



CLEVIS GRAB  
HOOKS

### GRADE 30

ACIER AU CARBONE COULEUR GRIS / CARBON STEEL COLOUR GREY

NOTRE CODE	DESCRIPTION	CHARGE AMD. (lbs)
OUR CODE	DESCRIPTION	SAFE WORKING LOAD
CH140330	1/4	2600
CH140340	5/16	3900
CH140350	3/8	5400
CH140360	7/16	7200
CH140370	1/2	9200

### GRADE 70

ACIER D'ALLIAGE DE CHROMATE JAUNE / CHROMATE YELLOW STEEL PLATED

NOTRE CODE	DESCRIPTION	CHARGE AMD. (lbs)
OUR CODE	DESCRIPTION	SAFE WORKING LOAD
CH140335	1/4	3150
CH140345	5/16	4700
CH140355	3/8	6600
CH140361	7/16	8800
CH140371	1/2	11300

CROCHETS  
GRAPPIN À ŒIL



EYE TYPE  
GRAB HOOKS

### GRADE 30

ACIER AU CARBONE COULEUR GRIS / CARBON STEEL COLOUR GREY

NOTRE CODE	DESCRIPTION	CHARGE AMD. (lbs)
OUR CODE	DESCRIPTION	SAFE WORKING LOAD
*****	1/4	2600
*****	5/16	3900
*****	3/8	5400

## CROCHETS FORGÉS POUR CHAÎNE / FORGED CHAIN HOOKS

CROCHETS COULISSANTS  
À MANILLE



CLEVIS SLIP  
HOOKS

### GRADE 30

ACIER AU CARBONE COULEUR GRIS / CARBON STEEL COLOUR GREY

NOTRE CODE	DESCRIPTION	CHARGE AMD. (lbs)
OUR CODE	DESCRIPTION	SAFE WORKING LOAD
CH140390	1/4	1950
CH140400	5/16	2875
CH140410	3/8	4000
CH140407	7/16	5000
CH140411	1/2	6500

### GRADE 70

ACIER D'ALLIAGE DE CHROMATE JAUNE / CHROMATE YELLOW STEEL PLATED

NOTRE CODE	DESCRIPTION	CHARGE AMD. (lbs)
OUR CODE	DESCRIPTION	SAFE WORKING LOAD
CH140392	1/4	2750
CH140401	5/16	4300
CH140408	3/8	5250
CH140413	7/16	7000
*****	1/2	9000

CROCHETS COULISSANTS  
À ŒIL



EYE TYPE  
SLIP HOOKS

### GRADE 30

ACIER AU CARBONE COULEUR GRIS / CARBON STEEL COLOUR GREY

NOTRE CODE	DESCRIPTION	CHARGE AMD. (lbs)
OUR CODE	DESCRIPTION	SAFE WORKING LOAD
*****	1/4	1950
*****	5/16	2875
CH140409	3/8	4000



Tel.: (819) 346-2903 / (888) 345-2903 Fax.: (819) 346-3389  
Email: distributeur@boulonstrie.com



CROCHETS À ŒIL AVEC  
LINGUET DE SÉCURITÉ  
POUR CABLE



EYE HOOKS WITH  
SECURITY LATCH  
FOR CABLE

**ACIER AU CARBONE / CARBON STEEL**

NOTRE CODE	CHARGE ADM.	OUVERTURE (LINGUET)	DIAMÈTRE ŒILLET
OUR CODE	ADM. CHARGE	OPENING (LATCH)	EYE DIAMETER
CH140414	3/4 T	7/8	3/4
CH140415	1 T	1	7/8
CH140416	1 1/2 T	1 1/16	1 1/8
*****	2 T	1 1/4	1 3/16
*****	3 T	1 1/2	1 9/16
*****	5 T	1 7/8	2
*****	7 1/2 T	2 1/4	-

LINGUETS

LATCHES

**ACIER INOXYDABLE / STAINLESS STEEL**

NOTRE CODE	CHARGE ADM.
OUR CODE	ADM. CHARGE
CH140417	3/4 - 1 T

CROCHETS GRAPPIN  
À MANILLE GRADE 70

CLEVIS GRAB HOOKS  
GRADE 70

AVEC LINGUET / WITH LATCH

NOTRE CODE	DESCRIPTION	CHARGE ADM. (lbs)
OUR CODE	DESCRIPTION	SAFE WORKING LOAD
*****	1/4	3150
*****	5/16	4700
CH140404	3/8	6600
*****	1/2	11300

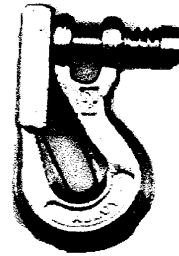

ACCESSOIRES POUR CHÂÎNE DE LEVAGE  
GRADE 80

CROCHETS GRAPPIN  
À MANILLE

CLEVIS GRAB  
HOOKS



NOTRE CODE	DESCRIPTION	CHARGE ADM. (lbs)
OUR CODE	DESCRIPTION	SAFE WORKING LOAD
*****	9/32	3500
CH140356	3/8	7100
*****	1/2	12000
*****	5/8	18100
*****	3/4	28300

CROCHETS COULISSANTS  
D'ÉLINGUE À MANILLE

CLEVIS CHAIN  
SLIP HOOKS



AVEC LINGUET DE SÉCURITÉ / WITH SECURITY LATCH

NOTRE CODE	DESCRIPTION	CHARGE ADM. (lbs)
OUR CODE	DESCRIPTION	SAFE WORKING LOAD
*****	9/32	3500
CH140405	3/8	7100
*****	1/2	12000
*****	5/8	18100
*****	3/4	28300



Tel.: (819) 346-2903 / (888) 345-2903 Fax.: (819) 346-3389

Email: distributeur@boulonsestrie.com

NOTRE CODE	CAPACITÉ	HAUTEUR LIBRE	ÉLÉVATION NORMALE
OUR CODE	CAPACITY	CLEARANCE HEIGHT	STANDARD LIFT
	TONNE / TON	PO / IN	PI / FT
*****	1/2 t.	12"	10'
QP0TR110	1	15"	10'
QP0TR115	1 1/2	16"	10'
*****	2	18"	10'
*****	3	21"	10'

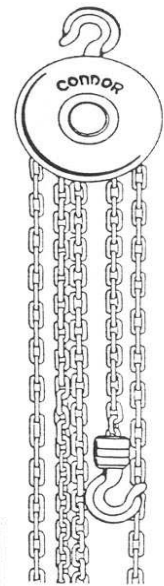

ENGRENAGE TRIPLE, FABRIQUÉ D'ACIER DE HAUTE QUALITÉ.  
 CHAÎNE EN ALLIAGE D'ACIER TRAITÉ THERMIQUEMENT.  
 MODÈLE LÉGER, UTILISATION FACILE ET SÉCURITAIRE.  
 MEULÉ AVEC PRÉCISION, CROCHETS EN ACIER FORGÉ.

TRIPLE SPURED GEARS OF HIGH QUALITY STEEL,  
 WITH PRECISION CUT TEETH.  
 FORGED STEEL HOOKS HIGH ALLOY HEAT TREATED STEEL CHAIN.  
 SAFETY IN OPERATION, LIGHT WEIGHT AND EASY HANDLING.

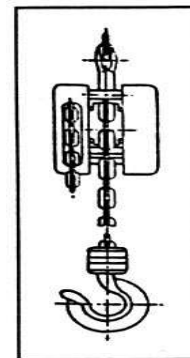

CHARIOTS

TROLLEY

NOTRE CODE	CAPACITÉ	POUR POUTRE EN " I "
OUR CODE	CAPACITY	FOR " I " BEAM
QP0PT410	1 t.	2" - 5"
QP0PT420	2	3" - 6"
*****	3	3" - 6"

COUSSINETS À ROULEAUX.  
 CHARIOTS RÉGLABLE "SPEED".

ROLLER BEARINGS.  
 "SPEED" ADJUSTABLE TROLLEY.

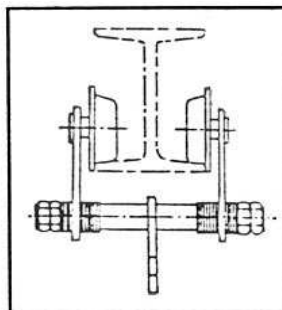
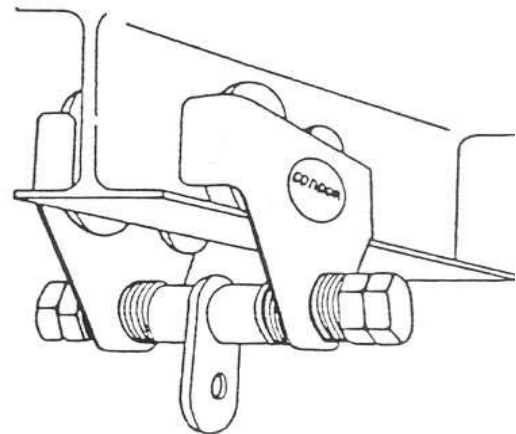

Tel.: (819) 346-2903 / (888) 345-2903 Fax.: (819) 346-3389

Email: distributeur@boulonsestrie.com



# "Golden pin"

NOTRE CODE	DESCRIPTION	CHARGE ADM. (TONNES)
OUR CODE	DESCRIPTION	ADM.CHARGE(TONS)
CH140470	3/16	1/3
CH140471	1/4	1/2
CH140472	5/16	3/4
CH140473	3/8	1
CH140474	7/16	1 1/2
CH140475	1/2	2
CH140476	5/8	3 1/4
CH140477	3/4	4 3/4
CH140478	7/8	6 1/2
CH140479	1	8 1/2
*****	1 1/8	9 1/2
*****	1 1/4	12
CH140481	1 3/8	13 1/2
*****	1 1/2	17
*****	1 3/4	25
*****	2	35
*****	2 1/2	55

**\* NE JAMAIS DÉPASSER LA CHARGE ADM. ÉCRITE PLUS HAUT\***  
**\*DON'T OVERLOADED (VERIFY AMD.CHARGE)\***

**AUSSI DISPONIBLE / ALSO AVAILABLE**

**MANILLES D'ANCRAGE EN ACIER INOXYDABLE SS316**  
**CLEVIS SCREWS IN STAINLESS STEEL SS316**



Tel.: (819) 346-2903 / (888) 345-2903 Fax.: (819) 346-3389

Email: distributeur@boulonsestrie.com



**FINI GALVANISÉ / GALVANIZED FINISH**

NOTRE CODE	DESCRIPTION	CHARGE ADM.(TONNES)
OUR CODE	DESCRIPTION	ADM. CHARGE (TONS)
CH140459	3/16	1/3
CH140460	1/4	1/2
CH140461	5/16	3/4
CH140462	3/8	1
CH140463	7/16	1 1/2
CH140464	1/2	2
CH140465	5/8	3 1/4
CH140466	3/4	4 3/4
CH140467	1	8 1/2
CH140468	1 1/8	9 1/2

**\*\*NE JAMAIS DÉPASSER LA CHARGE ADM. ÉCRITE PLUS HAUT\*\***  
**\*\*DON'T OVERLOADED (VERIFY AMD. CHARGE)\*\***

**\*\*\* SANS CLASSIFICATION DE CHARGE \*\*\***

**ZINC/PLATED**

NOTRE CODE	DESCRIPTION	CHARGE ADM.
OUR CODE	DESCRIPTION	ADM. CHARGE
CH140450	1/4	<p>SANS CLASSIFICATION *****</p>
CH140451	5/16	
CH140452	3/8	
CH140453	7/16	
CH140454	1/2	
CH140455	5/8	
CH140456	3/4	
CH140457	7/8	

**\*\*CES MANILLES D'ANCRAGE NE SONT PAS CONÇUES POUR DES APPLICATIONS DE LEVAGE\*\***

**\*\*THOSE CLEVIS SCREWS ARE NOT CONCEIVE TO LIFT\*\***



**Tel.: (819) 346-2903 / (888) 345-2903 Fax.: (819) 346-3389**

**Email: distributeur@boulonsestrie.com**

MAILLONS À RIVET

RIVET LINKS

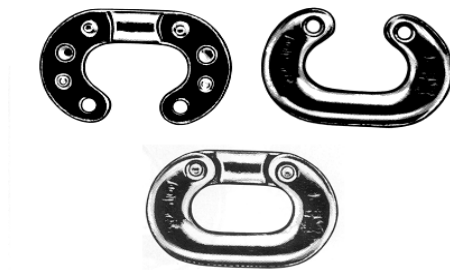

NOTRE CODE	DESCRIPTION	LONGUEUR INTERNE	LARGEUR INTERNE
OUR CODE	DESCRIPTION	INDIDE LENGTH	INSIDE WIDTH
CH140979	3/16	11/16	11/32
CH140980	1/4	7/8	7/16
CH140981	5/16	15/16	15/32
CH140982	3/8	1 1/8	9/16
CH140983	1/2	1 15/32	21/32
*****	5/8	1 13/16	25/32
*****	3/4	2 1/8	15/16
*****	7/8	2 1/2	1 1/8

MAILLONS RAPIDES

QUICK LINKS

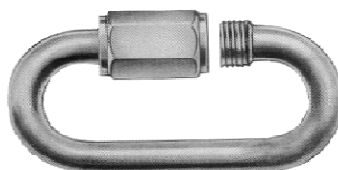

NOTRE CODE	DESCRIPTION	LONGUEUR INTERNE	LARGEUR INTERNE
OUR CODE	DESCRIPTION	INDIDE LENGTH	INSIDE WIDTH
CH140600	1/8	31 mm	11 mm
*****	5/32	34 mm	12 mm
CH140610	3/16	39 mm	13 mm
CH140620	1/4	45 mm	14 mm
CH140630	5/16	58 mm	17 mm
CH140640	3/8	70 mm	21 mm
CH140650	7/16	78 mm	22 mm
CH140660	1/2	80 mm	24 mm



Tel.: (819) 346-2903 / (888) 345-2903 Fax.: (819) 346-3389

Email: [distributeur@boulonstrie.com](mailto:distributeur@boulonstrie.com)

**GOUPILLES À ANNEAU**

**LINCH PINS**

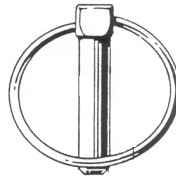

NOTRE CODE	DIAMÈTRE GOUPILLE	LONGUEUR GOUPILLE
OUR CODE	PIN DIAMETER	PIN LENGTH
CH187187	3/16	1 9/16
CH187188	1/4	1 3/4
CH187189	5/16	1 3/4
CH187191	3/8	1 3/4
CH187192	7/16	1 3/4

**GOUPILLES D'ATTACHE**

**HITCH PINS**

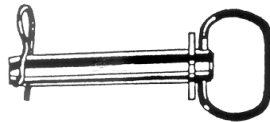

NOTRE CODE	DIAMÈTRE GOUPILLE	LONGUEUR GOUPILLE
OUR CODE	PIN DIAMETER	PIN LENGTH
CH187208	5/8	3 3/4
CH187209	5/8	6
CH187210	3/4	6 1/4
CH187212	7/8	6 1/2
CH187249	1	4 3/4
CH187250	1	6 3/4

**ANNEAUX À CLÉ**

**KEY RINGS**

NOTRE CODE	DIAMÈTRE EXTÉRIEUR
OUR CODE	OUTSIDE DIAMETER
KR000625	5/8
KR000750	3/4
KR001000	1
KR001500	1 1/2
KR002000	2

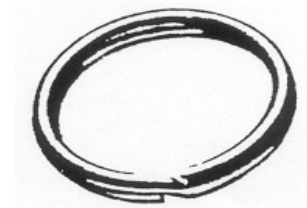

# SUR DEMANDE / ON REQUEST



MAILLONS FROIDS  
STEEL COLD SHUT

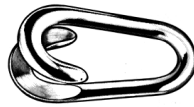

MAILLONS FENDUS  
SPLIT REPAIR LINKS



MAILLONS JUMEAUX  
MID LINKS



\*\*\*\*\*VOIR PAGE Q-13\*\*\*\*\*

SANGLES EN CAOUTCHOUC AVEC CROCHETS  
RUBBER TARP STRAPS WITH HOOKS

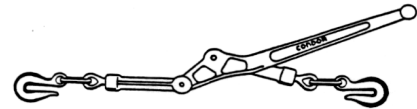

\*\*\*\*\*VOIR PAGE I-8\*\*\*\*\*

ATTACHES DE CHARGE  
LOAD BINDERS



ÉLINGUES DE CHAÎNE  
CHAIN SLINGS

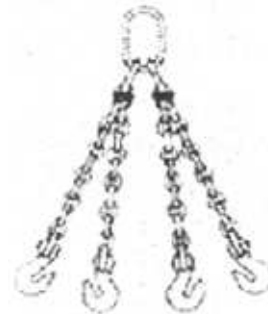

SIMPLE ,DOUBLE,TRIPLE ET QUADRUPLE



ÉMÉRILLONS EN FONTE MALLÉABLE PLAQUÉ ZINC  
MALLEABLE IRON CHAIN SWIVEL ZINC PLATED



Tel.: (819) 346-2903 / (888) 345-2903 Fax.: (819) 346-3389  
Email: distributeur@boulonsestrie.com



**ŒIL/ŒIL  
EYE/EYE**

TENDEURS

TURNBUCKLES



NOTRE CODE	#REF	DIA. FILETAGE	LONGUEUR FERMÉE	LONGUEUR OUVERTE	DIA. INT. ŒILLET	LONGUEUR DU CORPS
OUR CODE	#REF	THRED DIA.	CLOSED LENGTH	OPENED LENGTH	EYE INSIDE DIA.	BODY LENGTH
*****	5011	5/32	3 1/2	4 3/4	7/32	1 3/4
TU187037	5012	3/16	3 7/8	5 1/2	1/4	2 3/4
TU121047	5013	7/32	4 1/2	6 3/8	5/16	2 3/4
TU125055	5014	1/4	5 1/2	7 5/8	11/32	3 1/8
TU131070	5015	5/16	6 3/4	9 3/8	3/8	3 3/4
TU137075	5016	3/8	7 1/2	10 1/2	1/2	4 1/8

**CROCHET/ŒIL  
HOOK/EYE**

TENDEURS

TURNBUCKLES



NOTRE CODE	#REF	DIA. FILETAGE	LONGUEUR FERMÉE	LONGUEUR OUVERTE	DIA. INT. ŒILLET	LONGUEUR DU CORPS
OUR CODE	#REF	THREAD DIA.	CLOSED LENGTH	OPENED LENGTH	EYE INSIDE DIA.	BODY LENGTH
*****	5021	5/32	3 1/2	4 3/4	7/32	1 3/4
*****	5022	3/16	3 7/8	5 1/2	1/4	2 3/4
*****	5023	7/32	4 1/2	6 3/8	5/16	2 3/4
TU125030	5024	1/4	5 1/2	7 5/8	11/32	3 1/8
*****	5025	5/16	6 3/4	9 3/8	3/8	3 3/4
*****	5026	3/8	7 1/2	10 1/2	1/2	4 1/8

AUSSI DISPONIBLE SS-316 / ALSO AVAILABLE SS-316

PITONS AVEC ÉCROUS

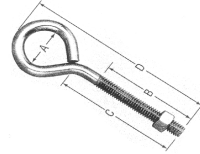

EYE BOLTS AND NUTS

NOTRE CODE	# REF	DIA. FILETAGE	LONGUEUR TOTALE	DIA. INT. ŒILLET	LONGUEUR FILATAGE	LONGUEUR TIGE
OUR CODE	# REF	THREAD DIA.	OVERALL LENGTH	EYE INSIDE DIA.	THREAD LENGTH	SHANK LENGTH
EB018020	5102	3/16	2	3/8	1 1/8	1 5/16
EB018025	5104	3/16	2 1/2	3/8	1 5/8	1 3/4
EB025020	5106	1/4	2	9/16	7/8	1
EB025025	5107	1/4	2 1/2	9/16	1 3/8	1 1/2
EB025030	5108	1/4	3	9/16	1 3/4	2
EB025040	5109	1/4	4	9/16	2 3/4	3
EB025050	5110	1/4	5	9/16	3	4
EB025060	5111	1/4	6	7/16	3	5
EB031032	5112	5/16	3 1/4	11/16	1 3/4	2
EB031040	5113	5/16	4	11/16	2 1/2	2 3/4
EB031050	5114	5/16	5	11/16	3	3 3/4
EB031060	5115	5/16	6	11/16	3	4 3/4
EB037040	5117	3/8	4	7/8	2 1/8	2 3/8
EB037050	5118	3/8	5	7/8	3 1/4	3 3/8
EB037060	5119	3/8	6	7/8	3 1/4	4 3/8
EB037080	5120	3/8	8	7/8	3 1/4	6 3/8
EB050060	5226	1/2	6	1 1/4	3	4
*****	5228	1/2	8	1 1/4	3	6
*****	5229	1/2	10	1 1/4	3	8
*****	5230	1/2	12	1 1/4	3	10

PITONS AVEC ÉCROUS AVEC ÉPAULEMENT  
EYE BOLTS SHOULDER & NUTS



ÉCROUS À ŒIL  
EYE NUTS



"A" SUITE, PETITS  
 ŒILLETS À VIS



SCREW EYES  
 "A" SUIT

NOTRE CODE	#REF	LONG. TOTALE	LONGUEUR TIGE	DIA. FIL	DIA. INT. ŒILLET
OUR CODE	#REF	OVERALL LENGTH	SHANK LENGTH	WIRE DIA.	EYE INSIDE DIA.
*****	5401	5/8	3/8	1/16	1/8
*****	5402	3/4	15/32	3/32	9/64
OV00093	5404	7/8	9/16	3/32	5/32
*****	5406	1 3/32	37/64	1/8	13/64
*****	5408	1 5/16	3/4	5/32	1/4
OV001562	5410	1 9/16	15/16	3/16	9/32
OV000500	5415	1/2	7/32	1/16	9/64
*****	5417	7/16	7/32	1/16	1/8

"B" SUITE, ŒILLETS  
 À VIS MÉDIUM



MEDIUM SCREW EYES  
 "B" SUIT

NOTRE CODE	#REF	LONG. TOTALE	LONGUEUR TIGE	DIA. FIL	DIA. INT. ŒILLET
OUR CODE	#REF	OVERALL LENGTH	SHANK LENGTH	WIRE DIA.	EYE INSIDE DIA.
OV000812	5501	13/16	1/2	.070	7/32
OV000875	5502	7/8	1/2	.083	15/64
OV001000	5504	1	9/16	.106	9/32
OV001125	5506	1 1/8	5/8	.128	5/16
OV001312	5508	1 5/16	3/4	.158	11/32
OV001561	5510	1 9/16	7/8	.182	3/8
OV001875	5512	1 7/8	1 1/8	.205	15/32
OV002125	5514	2 1/8	1 1/8	.232	1/2
OV002375	5516	2 3/8	1 3/8	.270	17/32
OV002625	5518	2 5/8	1 1/2	.292	9/16
OV002875	5520	2 7/8	1 5/8	.320	5/8





NOTRE CODE	#REF	DIA. FILETAGE	LONG. FILETAGE	LONG. TOTALE	LONG. TIGE	DIA. INT CILLET
OUR CODE	#REF	THREAD DIA.	THREAD LENGTH	OVERALL LENGTH	SHANK LENGTH	EYE INSIDE DIA.
PB250037	5151	1/4	1 9/16	3 3/4	2 3/4	9/16
PB250050	5152	1/4	1 9/16	5	4	9/16
PB315040	5153	5/16	1 9/16	4	2 3/4	3/4
PB315060	5154	5/16	1 9/16	6	4 3/4	3/4
PB375045	5155	3/8	1 3/4	4 1/2	3	7/8
PB375080	5156	3/8	1 3/4	8	6 1/4	7/8





NOTRE CODE	# REF	RÉSISTANCE (lb.)	QTÉ/BTE
OUR CODE	#REF	RESISTANCE (kg ou g)	QTY/BOX
*****	BL30685	1 lb./500 g	6
*****	BL30690	5 lb./2 kg	6
CC000010	BL30695	10 lb./4.5 kg	6
CC000020	BL30700	20 lb./9 kg	6
CC000030	BL30705	30 lb./14 kg	5
CC000040	BL30710	40 lb./18 kg	4
*****	BL30715	50 lb./23 kg	3
CC000100	BL30720	100 lb. /45 kg	2

CROCHETS EN "S"



"S" HOOKS

NOTRE CODE	#REF	DIA. FIL X LONG. TOTAL	QTÉ/BTE
OUR CODE	#REF	WIRE DIA. X OVERALL LENGTH	QTY/BOX
SH000100	5130	3/32 X 1	100
SH000140	5131	1/8 X 1 1/2	20
SH000176	5132	3/16 X 2	20
SH000212	5134	1/4 X 2 1/2	20
SH000307	5136	5/16 X 3	20

"M" SUIT



SCREW HOOKS

CROCHETS VIS

"M" SUIT

NOTRE CODE	#REF	DIA. FIL X LONG. TOTAL	QTÉ/BTE
OUR CODE	#REF	WIRE DIA. X OVERALL LENGTH	QTY/BOX
*****	5702	3/32 X 1 3/8	100
CV001625	5704	3/32 X 1 5/8	100
*****	5706	1/8 X 1 7/8	100
CV002250	5708	5/32 X 2 1/4	100
CV002750	5710	3/16 X 2 3/4	100
*****	5712	7/32 X 3 1/4	100
CV003750	5714	1/4 X 3 3/4	50
CV004250	5716	9/32 X 4 1/4	50
CV004500	5718	9/32 X 4 1/2	50
CV004501	5720	5/16 X 4 1/2	50



NOTRE CODE	#REF	DIA. FIL X LONGUEUR TOTALE	QTÉ/BTE
OUR CODE	#REF	WIRE DIA. X OVERALL LENGTH	QTY/BOX
CC512012	5732	1/8 X 1 1/4	100
CC512015	5735	1/8 X 1 1/2	100
CC515020	5737	5/32 X 2	100
CC518030	5740	3/16 X 3	100

CROCHETS À VIS  
EN LAITON

BRASS SCREW  
(SHOULDER) HOOKS



NOTRE CODE	#REF	GRANDEUR X DIA. FIL X LONGUEUR TOTALE	QTÉ/BTE
OUR CODE	#REF	SIZE X WIRE DIA. X OVERALL LENGTH	QTY/BOX
*****	5750	1/2 X 1/16 X 7/8	100
*****	5752	3/4 X 3/32 X 1 1/8	100
CC005754	5754	1" X 1/8 X 1 1/2	100

CROCHETS DE TASSE  
EN LAITON

CUP HOOKS  
BRASS



NOTRE CODE	#REF	GRANDEUR X DIA. FIL X LONGUEUR TOTALE	QTÉ/BTE
OUR CODE	#REF	SIZE X WIRE DIA. X OVERALL LENGTH	QTY/BOX
CT000500	5780	1/2 X 3/32 X 7/8	100
CT000625	5781	5/8 X 3/32 X 1	100
CT000750	5782	3/4 X 3/32 X 1 1/8	100
CT000875	5783	7/8 X 1/8 X 1 5/16	100
CT001000	5784	1 X 1/8 X 1 1/2	100
CT001250	5785	1 1/4 X 5/32 X 1 3/4	50
CT001500	5786	1 1/2 X 5/32 X 2 1/8	50

CROCHETS DE PORTE  
À ŒILLETS À VIS

GATE HOOKS  
AND SCREW EYES



NOTRE CODE	#REF	DIA. FIL X LONGUEUR TOTALE	QTÉ/BTE
OUR CODE	#REF	WIRE DIA. X OVERALL LENGTH	QTY/BOX
*****	5815	1/8 X 1 1/2	100
CP000200	5820	5/32 X 2	100
*****	5825	5/32 X 2 1/2	100
CP000300	5830	3/16 X 3	100



NOTRE CODE	#REF	DIA. FIL X LONGUEUR TOTALE	QTÉ/BTE
OUR CODE	#REF	WIRE DIA. X OVERALL LENGTH	QTY/BOX
CP000400	5840	3/16 X 4	50
CP000600	5860	1/4 X 6	50
*****	5908	3/16 X 8	50
*****	5910	3/16 X 10	20
*****	5912	3/16 X 12	20

BOULONS À ANNEAU  
AVEC ÉCROUS



RING BOLTS  
AND NUTS

NOTRE CODE	#REF	LONGUEUR DE LA TIGE (RING DIA.)	QTÉ/BTE
OUR CODE	#REF	SHANK LENGHT(DIAMÈTRE ANNEAU)	QTY/BOX
*****	5172	2 1/2 (2 X 9/32)	10
*****	5173	6 (2 X 9/32)	10

ANNEAUX D'ACCROCHAGE À BOIS



HITCHING RINGS (LAG THREAD)

NOTRE CODE	#REF	DIAM. ANNEAU X (LONGUEUR TIGE)	QTÉ/BTE
OUR CODE	#REF	RING DIAMETER X (SHANK LENGTH)	QTY/BOX
Q0005177	5177	2" X 5/16 X (2 1/2")	10

ANNEAUX D'ACCROCHAGE



HITCHING RINGS (PLATE STYLE)

NOTRE CODE	#REF	DIAM. ANNEAU X (GRANDEUR PLAQUE)	QTÉ/BTE
OUR CODE	#REF	RING DIAMETER X (PLATE SIZE)	QTY/BOX
Q0005178	5178	2" X 5/16 X (2 X 2")	10



EXEMPLE: 7/8 X 3 3/4  
 7/8 EST LE DIAMÈTRE  
 DE L'OEIL ET 3 3/4 EST  
 LA LONGUEUR DU MOUSQUETON

EXEMPLE: 7/8 X 3 3/4  
 7/8 IS THE EYE DIAMETER  
 AND 3 3/4 IS THE LENGTH SNAIL

MOUSQUETON  
 SIMPLEX ŒIL PIVOT



SIMPLEX WIRE SNAP  
 SWIVEL EYE

N° DE RÉFÉRENCE	DIAMÈTRE ŒIL X LONGUEUR	QTÉ/EMB
REFERENCE N°	EYE DIAMETER X LENGTH	QTY/PACK
734A	1/2 X 1 1/2	10

MOUSQUETON  
 ŒIL FIXE



BABY SNAP  
 FIX EYE

N° DE RÉFÉRENCE	DIAMÈTRE ŒIL X LONGUEUR	QTÉ/EMB
REFERENCE N°	EYE DIAMETER X LENGTH	QTY/PACK
150	3/8 X 1 3/4	10

MOUSQUETON  
 ŒIL ROND



CHAMPION SNAP  
 ROUND EYE

N° DE RÉFÉRENCE	DIAMÈTRE ŒIL X LONGUEUR	QTÉ/EMB
REFERENCE N°	EYE DIAMETER X LENGTH	QTY/PACK
108-19	3/4 X 3 3/8	10

MOUSQUETON  
 ŒIL PIVOT OUVERT



CHAMPION SNAP  
 OPEN SWIVEL EYE

N° DE RÉFÉRENCE	DIAMÈTRE ŒIL X LONGUEUR	QTÉ/EMB
REFERENCE N°	EYE DIAMETER X LENGTH	QTY/PACK
1087	3/8 X 2 1/2	10

MOUSQUETON  
 ŒIL ROND PIVOT



CHAMPION SNAP  
 SWIVEL ROUND EYE

N° DE RÉFÉRENCE	DIAMÈTRE ŒIL X LONGUEUR	QTÉ/EMB
REFERENCE N°	EYE DIAMETER X LENGTH	QTY/PACK
1088	3/8 X 2 1/2	10



Tel.: (819) 346-2903 / (888) 345-2903 Fax.: (819) 346-3389  
 Email: distributeur@boulonsestrie.com



EXEMPLE: 7/8 X 3 3/4  
 7/8 EST LE DIAMÈTRE  
 DE L'OEIL ET 3 3/4 EST  
 LA LONGUEUR DU MOUSQUETON

EXEMPLE: 7/8 X 3 3/4  
 7/8 IS THE EYE DIAMETER  
 AND 3 3/4 IS THE LENGTH SNAIL

MOUSQUETON  
 ŒIL CARRÉ À ROULEAU



EYE SNAP, SQUARE  
 EYE WITH ROLLER

N° DE RÉFÉRENCE	DIAMÈTRE ŒIL X LONGUEUR	QTÉ/EMB
REFERENCE N°	EYE DIAMETER X LENGTH	QTY/PACK
1089	5/8 X 2 1/4	10

MOUSQUETONS À BOULON  
 ŒIL PIVOT



BOLT SNAPS  
 SWIVEL EYE

N° DE RÉFÉRENCE	DIAMÈTRE ŒIL X LONGUEUR	QTÉ/EMB
REFERENCE N°	EYE DIAMETER X LENGTH	QTY/PACK
50-10	3/8 X 3	10
CH145013	1/2 X 3	10
50-16	5/8 X 3 1/4	10
CH145019	3/4 X 3 3/8	10
CH145020	1 X 3 7/8	10
CH145021	1 1/8 X 4 1/4	10

MOUSQUETON À BOULON  
 ŒIL OUVERT



BOLT SNAP  
 OPEN EYE

N° DE RÉFÉRENCE	DIAMÈTRE ŒIL X LONGUEUR	QTÉ/EMB
REFERENCE N°	EYE DIAMETER X LENGTH	QTY/PACK
70	5/8 X 4	10

MOUSQUETONS À BOULONS  
 ŒIL CARRÉ PIVOT



BOLT SNAPS  
 SQUARE SWIVEL EYE

N° DE RÉFÉRENCE	DIAMÈTRE ŒIL X LONGUEUR	QTÉ/EMB
REFERENCE N°	EYE DIAMETER X LENGTH	QTY/PACK
CH145219	3/4 X 3	10
CH145014	1 X 3	10



Tel.: (819) 346-2903 / (888) 345-2903 Fax.: (819) 346-3389  
 Email: distributeur@boulonsestrie.com

EXEMPLE: 7/8 X 3 3/4  
 7/8 EST LE DIAMÈTRE  
 DE L'OEIL ET 3 3/4 EST  
 LA LONGUEUR DU MOUSQUETON

EXEMPLE: 7/8 X 3 3/4  
 7/8 IS THE EYE DIAMETER  
 AND 3 3/4 IS THE LENGTH SNAP

MOUSQUETONS À  
 BOULON DOUBLE



DOUBLE BOLT SNAPS

N° DE RÉFÉRENCE	DIAMÈTRE ŒIL X LONGUEUR	QTÉ/EMB
REFERENCE N°	EYE DIAMETER X LENGTH	QTY/PACK
72-35	1/2 X 3 1/2	10
CH140724	1/2 X 4	10
72-45	1/2 X 4 1/2	10

MOUSQUETONS  
 ŒIL CARRÉ FIXE  
 ACIER MALLÉABLE



CHAMPION SNAPS  
 SQUARE FIXED EYE  
 MALLEABLE CAST STEEL

N° DE RÉFÉRENCE	DIAMÈTRE ŒIL X LONGUEUR	QTÉ/EMB
REFERENCE N°	EYE DIAMETER X LENGTH	QTY/PACK
135-19	3/4 X 2 5/8	10
135-25	1 X 3 1/8	10
135-29	1 1/8 X 3 1/8	10
135-38	1 1/2 X 3 1/8	5
135-51	2 X 3 1/2	5

MOUSQUETONS  
 ŒIL PIVOT  
 RESSORT INOXYDABLE

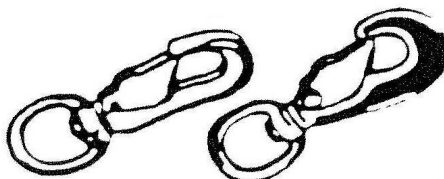

LEVER SNAPS  
 SWIVEL EYE  
 STAINLESS SPRINGS

N° DE RÉFÉRENCE	DIAMÈTRE ŒIL X LONGUEUR	QTÉ/EMB
REFERENCE N°	EYE DIAMETER X LENGTH	QTY/PACK
188-16	5/8 X 3 1/8	10
188-19	3/4 X 3 1/4	10
188-25	1 X 1 1/2	10
CH141829	1 1/8 X 4 3/4	10



Tel.: (819) 346-2903 / (888) 345-2903 Fax.: (819) 346-3389  
 Email: distributeur@boulonsestrie.com

EXEMPLE: 7/8 X 3 3/4  
 7/8 EST LE DIAMÈTRE  
 DE L'OEIL ET 3 3/4 EST  
 LA LONGUEUR DU MOUSQUETON

EXEMPLE: 7/8 X 3 3/4  
 7/8 IS THE EYE DIAMETER  
 AND 3 3/4 IS THE LENGTH SNAP

MOUSQUETON ŒIL DOUBLE



SNAP DOUBLE BREAST

N° DE RÉFÉRENCE	DIAMÈTRE ŒIL X LONGUEUR	QTÉ/EMB
REFERENCE N°	EYE DIAMETER X LENGTH	QTY/PACK
187	5	5

MOUSQUETOS TYPE  
 CISEAU, ŒIL PIVOT

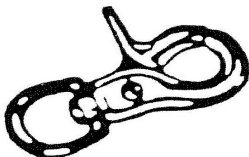

SCISSOR SNAP  
 SWIVEL EYE

N° DE RÉFÉRENCE	DIAMÈTRE ŒIL X LONGUEUR	QTÉ/EMB
REFERENCE N°	EYE DIAMETER X LENGTH	QTY/PACK
CH140875	5/8 X 3	10

MOUSQUETONS  
 SÉCURITAIRE, ŒIL PIVOT



SECURITY SNAP HOOKS  
 SWIVEL EYE

N° DE RÉFÉRENCE	DIAMÈTRE ŒIL X LONGUEUR	QTÉ/EMB
REFERENCE N°	EYE DIAMETER X LENGTH	QTY/PACK
3142	7/8 X 3 3/4	10
3145	1 X 5	5

MOUSQUETON  
 ANTI-PANIQUE, ŒIL FIXE



PANIC SNAP  
 FIXED EYE

N° DE RÉFÉRENCE	DIAMÈTRE ŒIL X LONGUEUR	QTÉ/EMB
REFERENCE N°	EYE DIAMETER X LENGTH	QTY/PACK
1001	1/2 X 4	5



Tel.: (819) 346-2903 / (888) 345-2903 Fax.: (819) 346-3389  
 Email: distributeur@boulonsestrie.com

EXEMPLE: 7/8 X 3 3/4  
 7/8 EST LE DIAMÈTRE  
 DE L'OEIL ET 3 3/4 EST  
 LA LONGUEUR DU MOUSQUETON

EXEMPLE: 7/8 X 3 3/4  
 7/8 IS THE EYE DIAMETER  
 AND 3 3/4 IS THE LENGTH SNAIL

MOUSQUETON  
 ANTI-PANIQUE  
 ŒIL PIVOT

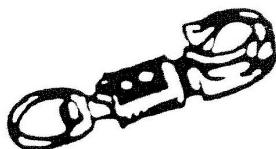

PANIC SNAP  
 SWIVEL EYE

N° DE RÉFÉRENCE	DIAMÈTRE ŒIL X LONGUEUR	QTÉ/EMB
REFERENCE N°	EYE DIAMETER X LENGTH	QTY/PACK
1002	7/8 X 4 3/4	5

MOUSQUETON  
 D'AMARRAGE



MOORING  
 SNAP

N° DE RÉFÉRENCE	DIAMÈTRE ŒIL X LONGUEUR	QTÉ/EMB
REFERENCE N°	EYE DIAMETER X LENGTH	QTY/PACK
2311	3/4 X 3 1/2	5

MOUSQUETONS DE  
 SÉCURITÉ



SECURITY WIRE  
 SNAP HOOKS

PLAQUÉ ZINC

ZINC PLATED

N° DE RÉFÉRENCE	DIAMÈTRE ŒIL X LONGUEUR	QTÉ/EMB
REFERENCE N°	EYE DIAMETER X LENGTH	QTY/PACK
CH140187	3/16 X 2	10
CH140250	1/4 X 2 1/4	10
CH140315	5/16 X 3 1/8	10
CH140316	3/8 X 4	10
2355/120	7/16 X 4 3/4	10
2355/140	15/32 X 5 1/2	10



Tel.: (819) 346-2903 / (888) 345-2903 Fax.: (819) 346-3389  
 Email: distributeur@boulonstrie.com

EXEMPLE: 7/8 X 3 3/4  
 7/8 EST LE DIAMÈTRE  
 DE L'OEIL ET 3 3/4 EST  
 LA LONGUEUR DU MOUSQUETON

EXEMPLE: 7/8 X 3 3/4  
 7/8 IS THE EYE DIAMETER  
 AND 3 3/4 IS THE LENGTH SNAP

## MOUSQUETONS EN LAITON POUR BATEAU / POLISH BRASS BOAT SNAP

MOUSQUETONS À BOULON  
 ŒIL PIVOT



BOLT SNAPS  
 SWIVEL EYE

N° DE RÉFÉRENCE	DIAMÈTRE ŒIL X LONGUEUR	QTÉ/EMB
REFERENCE N°	EYE DIAMETER X LENGTH	QTY/PACK
CH142359	1/2 X 3 1/8	10
CH142360	3/4 X 3 1/4	10
2359-25	1 X 3 1/2	10

MOUSQUETONS POUR  
 BATEAU À ŒIL FIXE



BOAT SNAPS  
 FIXED EYE

N° DE RÉFÉRENCE	DIAMÈTRE ŒIL X LONGUEUR	QTÉ/EMB
REFERENCE N°	EYE DIAMETER X LENGTH	QTY/PACK
2363 * 0	7/16 X 2 1/8	10
2363 * 1	5/8 X 2 7/8	10
CH142363	3/4 X 3 1/4	10
2363 * 3	3/4 X 3 7/8	10

MOUSQUETONS POUR BATEAU  
 ŒIL PIVOT



BOAT SNAPS  
 SWIVEL EYE

N° DE RÉFÉRENCE	DIAMÈTRE ŒIL X LONGUEUR	QTÉ/EMB
REFERENCE N°	EYE DIAMETER X LENGTH	QTY/PACK
2364 * 1	5/8 X 3 1/4	10
2364 * 2	3/4 X 3 3/4	10
CH142364	3/4 X 4 1/4	10



Tel.: (819) 346-2903 / (888) 345-2903 Fax.: (819) 346-3389  
 Email: distributeur@boulonsestrie.com

EXEMPLE: 7/8 X 3 3/4  
 7/8 EST LE DIAMÈTRE  
 DE L'OEIL ET 3 3/4 EST  
 LA LONGUEUR DU MOUSQUETON

EXEMPLE: 7/8 X 3 3/4  
 7/8 IS THE EYE DIAMETER  
 AND 3 3/4 IS THE LENGTH SNAP

MOUSQUETON À BOULON  
 DOUBLE, EN LAITON



BRASS BOLT SNAP  
 DOUBLE EYE

N° DE RÉFÉRENCE	DIAMÈTRE OEIL X LONGUEUR	QTÉ/EMB
REFERENCE N°	EYE DIAMETER X LENGTH	QTY/PACK
CH140163	1/2 X 4 1/2	10

MOUSQUETON EN LAITON  
 OEIL OUVERT



BRASS BOLT SNAP  
 OPEN EYE

N° DE RÉFÉRENCE	DIAMÈTRE OEIL X LONGUEUR	QTÉ/EMB
REFERENCE N°	EYE DIAMETER X LENGTH	QTY/PACK
CH140164	1/2 X 4	10

MOUSQUETON DE  
 SECURITÉ, BRONZE

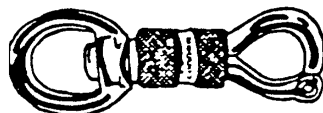

SECURITY SNAP  
 HOOK, BRONZE

N° DE RÉFÉRENCE	DIAMÈTRE OEIL X LONGUEUR	QTÉ/EMB
REFERENCE N°	EYE DIAMETER X LENGTH	QTY/PACK
CH143002	1 X 4 1/2	5

ANNEAUX SOUDÉS EN ACIER  
 PLAQUÉ NICKEL



NICKEL PLATED WELDED  
 STEEL RINGS (HARNES)

N° DE RÉFÉRENCE	DIAMÈTRE OEIL X LONGUEUR	QTÉ/EMB
REFERENCE N°	EYE DIAMETER X LENGTH	QTY/PACK
1336* 1	3/16 X 1	20
CH931010	3/16 X 1 1/4	20
CH931012	1/4 X 1 1/2	20

ANNEAUX SOUDÉS  
 EN ACIER AU CARBONE,  
 GALVANISÉS À CHAUD



HOT DIP GALVANIZED WELDED  
 CARBON STEEL RINGS

N° DE RÉFÉRENCE	DIAMÈTRE OEIL X LONGUEUR	QTÉ/EMB
REFERENCE N°	EYE DIAMETER X LENGTH	QTY/PACK
CH931013	1/4 X 2	20
CH931025	5/16 X 2 1/2	10
1347-3	3/8 X 3	10